

Gotharman's Little deFormer 3



Granular Workstation

User Manual V10.63

Content Of This Manual

Introduction	9
Very Special Thanks To	11
In The Box	12
Getting Started	13
User Interface	20
Preset Select Screen	23
Operating LD3	27
Starting/stopping Sequencer/trigger parts manually	27
Selecting a Part	28
Selecting Effects Processors	28
Note Tracks Steps view/edit	29
Selecting Note Track Steps	30
Setting Note Track Last Step	31
Mute/Unmute Note Tracks	32
Copy Morph Layer A to B	33
Selecting the next Preset	33
Selecting the previous Preset	34
Selecting Presets using step buttons	35
Preset Reload	36
Panic	36
Compare Preset	37
Shortcuts to Edit Pages	38
Audio Bus System	40
LD3 Structure	41

Synth/Sampler Parts

[42](#)

Modulation Sources	43
Accessing The Synth Part Pages	50
Editing The Parameters	52
Parameters Randomizer	53
Trigger Setup	55
Zone Setup	57
Audio Bus Setup	58
Oscillator/Sampler/Noise	64
Granular Modulators	79
Random Generators	81
Digital Filters	82
VCA	91
Envelope 1 and 2	95
LFO 1 to 16	99
Audio Inputs Setup	102
Analog FilterBoards	103
SPACEboard 2	117
Effects Processors	139
Insert Effects 1 to 8	141
List of Insert Effects	142
Insert Effects Select Page	144
Mix Modulation and Backwards	146
Chorus	148
Distortion	150
Bit Crush	152
Pitch Shifter	154
Resonator	157
Stretcher	159
FM	161
Glitch Shifter 1, 2 and 3	163
Pitch Shaper	165
FAT	167
Filters	169
Filters 2	172
Compressor	174
Expandor	176
PitchShaper2	178
Delays	181

Variator	183
Time Stretch	185
Sample Pitch	187
Output Effects 1 and 2	189
List of Output Effects	190
Output Effects Select Page	192
Mix/Pan Modulation and Backwards	195
Delays	197
Granulator SQ	200
Variator	203
Reverb	205
Granulator (unsynced)	207
Xfade Granulator	210
Abstract0	213
Time Stretch	216
Sample Pitch	218

Sequencer

[220](#)

Entering The Sequencer	227
Sequencer Main	230
Clear Sequence	232
Note subtrack	233
Gate Time subtrack	236
Velocity subtrack	238
Position subtrack	240
Sub Position subtrack	242
Templates and Note Scales	244
Templates for Position subtrack	246
Note Track Mod page	248
Clear Note Track	250
Double Note Track	251
Realtime Recording of Notes	252
Step Recording of Notes	254
Track/Part Internal/External Operation	257
Audio Track Recording	260
Controller tracks	270
Controller Track templates	274
Controller Tracks CC page	276
Clear Controller Track	278
Double Controller Track	279
Adjusting The CV Scale	280
Controller Tracks Realtime recording	281
Recording Parameter Tweaks	284
CV Inputs Recording	285
Pitch Bend and CC recording auto setup	286
Controller Tracks Step Recording	288

Synth and Sequencer Morphing

[289](#)

More... Parameters/Setup		<u>290</u>
Common Settings	293	
Morph Setup	295	
Common Settings 2	299	
CV Inputs	300	
CV Outputs	303	
Initialize Preset	306	
Parameter Snap Mode	307	
FilterBoards Setup	309	
FLASH Memory Check	311	
Delete Sample Bank	312	
Delete All Presets and Songs	313	
C.P.	314	
Preset/Song Mode	315	
Display Update Rate	316	
Save Preset		<u>317</u>
Song Mode		<u>321</u>
Accessing Song Mode	322	
Song Edit page	326	
Song Select page	328	
Song Realtime Recording	330	
Save Song	<u>334</u>	
Initialize Song	338	
Copy/Paste		<u>340</u>
Sample Record and Edit		<u>343</u>
Recording a Sampling	344	
Edit a Sampling	352	
Adjusting Start/End Points	354	
Sample Chops	355	
Wave Chop System	359	
Deleting Last Recorded Sampling	367	
Deleting Other Samplings	369	
Graphical Sample Editing	370	
Wave Builder		<u>383</u>

USB		<u>386</u>
	USB Sample Preview	388
	Open A Directory	389
	Importing Files	390
	Importing Multiple Files	392
	Reload Multiple Files	393
	Import Samplings As Chops	395
	Make a New Directory	398
	Delete File From USB Drive	399
	Export Samples, Presets and Songs	400
	Updating LD3 Firmware	<u>402</u>
MIDI Specs		<u>409</u>
	Parameters CC Control	411
	List Of Parameter CC Numbers	413
	Effects Parameters 1 and 2	416
	Controlling Parameters From Controller Tracks	417
Safe Boot Mode		<u>418</u>
Installing/Exchanging Analog FilterBoards		<u>419</u>
Installing The Analog Board		<u>437</u>

I hope that you will deform some great tracks

Introduction

Thank you very much for purchasing/consider to purchase a Gotharman's Little deformer 3.

Little deformer 3 (sometimes shortened to LD3) are a multi-timbral and polyphonic granular workstation with 16 parts. The granular functions in it includes oscillator/sampler granular modulators and special granular effects.

Each of the 16 parts has a stereo oscillator/sampler, 2 filters with 16 different filter types, a stereo VCA, 3 envelopes, 4 random generators and 2 granular modulators, a random one and a sequenced one. Additional modulation sources includes 16 global LFO's, 32 sequencer controller tracks, 8 audio bus envelope followers, touch screen keyboard Y position and MIDI keyboard, velocity, aftertouch, pitch bend and CC's.

The samplers can hold up to 193 minutes of samplings/ maximum 8.192 samplings. Samplings can be chopped by level peaks, wave zero points, or in equally sized slices. Up to 64 chop points are possible for each sampling. Samples are stored in FLASH memory, and played back directly from this, so: No loading times!

Each part can be send to up to two of 8 audio busses at the same time. Pan modulation can control the send level to each of the 2 busses.

On the audio busses up to 8 insert effects and 4 analog filters can be placed, for processing the sounds from the parts and from its audio inputs. Up to 4 audio inputs are available (2 of them optional).

The output from the audio busses can be sent to any of up to 4 audio outputs (2 of them optional) and 2 output effect processors.

The 16 parts can be sequenced from a build-in sequencer, that has 16 note tracks, with up to 64 steps each, and 32 controller tracks, with up to 128 steps each. Each note track has a position track, that makes it possible to alter the position of each step, making polyphonic step sequencing and various direction modes possible. A sub position track is also available for micro timing. Realtime, step time and xox style recording are possible. Knob movements and MIDI CC's can be recorded, both in realtime and step time on the controller tracks.

Both the note tracks and the controller tracks can also control external MIDI devices, with up to 128 notes of polyphony.

Audio tracks can be recorded on the note tracks. These can be instantly chopped for true deforming manipulation.

The sound generating parts, the LFO's, the effects processors and the sequencer has 2 layers of parameter settings, layer A and layer B, that can be independently adjusted, and morphed between, using the Morph and Seq Morph knobs.

All the parameter settings can be stored in any of 1024 rewritable preset locations, and recalled at any time.

1024 song locations are available, for programmed playback of presets, and for tracks mute automation.

I hope that you will enjoy your LD3 for a long time, and deform a lot of great tracks.

Very special thanks to:

Chris Curtis

Michael Dunkley

Weinglas

Don Linder

Nick Nimick

Franck Superbaby

Alban Loisl

Laurent Stehly

El-Kartoff

Cameron Scott Cairney

Ole-Jacob Sand

Michal Lichy

For supporting this project from the start. I sincerely appreciate your help.

In The Box

In the LD3 box should be:

- LD3 itself
- A power supply –Multi plug –Works in most countries.

If any of these items are missing, please get in touch with Gotharman's.

Getting Started

Connecting:



On the right end panel of your LD3, you will find the power switch, connection for power supply, stereo audio outputs, USB, and MIDI in and out.

You would probably like to connect the audio outputs to a mixer or an amplifier, or anything else that ends out in a speaker/a set of speakers. Since LD3 doesn't have built in speakers, it just needs to be connected to something, that can transfer its amazing sound to you. These should be connected, using ¼" mono jack cables.

The left audio output (marked "AUDIO OUT L(hp)") doubles as a stereo headphone connector. Please make sure that nothing is connected to the right audio output, when plugging headphones into this connector.

If the LD3 touch screen keyboard and step buttons seems a bit too limited, you might want to connect a MIDI keyboard to MIDI in, in order to take full advantage of LD3's fully chromatically

playable sounds. It is also possible to connect anything that transmits a MIDI clock, if you would like the sequencer of LD3 to sync to the rest of your setup.

On MIDI out, MIDI clock, MIDI CC's from the LD3 edit knobs, and notes and CC's from its sequencer are transmitted. Connect any MIDI gear to this, that you would like to control from LD3.

To the USB connector, a USB drive can be connected.

This should be:

- Maximum 32 GB

- FAT formatted

With a USB drive connected, you can:

- Import, export and back up samples as .wav files

- Import deFormer .lds samples

- Import, export and back up LD3 presets and songs

- Update LD3

- PLEASE NOTICE: The included factory samples CANNOT be exported. So if you want to keep these, you should take care not to delete them. A USB stick with the factory samplings might be available in the future.

To import a .wav file from another device, it must be:

- Mono or stereo

- 44.1 KHz sample rate – LD3 will import other sample rates, but they will play back in a wrong speed

- 16 bit or 24 bit native PCM

- Standard wav's or broadcast wav's



On the left end panel of your LD3, you will find the stereo audio inputs. The optional extra audio inputs and outputs and the CV inputs and outputs are also found here, if installed.

Audio inputs L and R

The two rightmost 1/4" jack connectors, marked "AUDIO IN R L" are always the stereo audio inputs.

Connect any line stereo/mono audio sources to the audio input, for sampling and/or processing through LD3's effects and optional analog filters.

When 2 extra audio inputs and 2 extra audio outputs were ordered:

AUDIO IN/OUT 3 4 are the additional audio inputs 3 and 4, and AUDIO IN/OUT 5 6 are the additional audio outputs 3 and 4.

With SPAZEboard2 installed:

AUDIO IN/OUT 3, 4, 5 and 6 are separate audio outputs from analog VCF 1, 2, 3 and 4. For VCF 2 and 3, only the filterboards output 1 are outputted here.

When 4 extra audio inputs and 4 extra audio outputs were ordered:

The tip of AUDIO IN/OUT 3, 4, 5 and 6 are audio inputs 3 to 6, the ring of AUDIO IN/OUT 3, 4, 5 and 6 are audio outputs 3 to 6.

CV inputs and outputs

If you start counting from the left, the first 4 minijacks are CV input 1 to 4. The next 4 are CV output 1 to 4.

Connect any CV voltage source to the 4 CV inputs. Each input can be set up to match the voltage range of any CV source, up to +/- 15 volts. The CV inputs can be set up to modulate many parameters and they can be set up to act as trigger sources. They also accept clocks, start/stop and reset pulses for the sequencer.

Via the CV outputs it is possible to control analog gear. Each CV output, outputs both an adjustable static voltage, plus an LD3 modulation source, so it is possible to both adjust t.ex. the cutoff frequency of a connected analog filter, and to add modulation to this. It is also possible to output triggers via these, to trigger external gear.

With SPAZEboard2 installed, the CV outputs are:

- 1: VCF3 Feed parameter and modulation.
- 2: VCF3 Reso parameter and modulation.
- 3: VCF3 Cut parameter and modulation.
- 4: VCF3 Peaks parameter and modulation.

Starting Up

Connect the supplied power adaptor to the Power input, and to a 100V to 240V power source – Usually a wall socket.



It's a 9V, minimum 2.0A type with a 2.1 mm DC plug, with positive middle. The power supply on the picture is only for reference. The actual one might look different.

Some LD3's might have been shipped out with a power adaptor, that has multiple tips. If you have received one of these, you should use the tip with the blue ring, and make sure that the 2 parts are aligned to the text "Tip":

Please look at the picture, on the next page....



Turn it on

Push the “I” on the power switch. Your LD3 should now turn on.

The User Interface



LD3 has a highly sensitive and responsive capacitive touch display, 16 step/trigger/part select/quick jump buttons, a Morph Set button, a Func/Mute button, a Steps/Part button and a Sequencer Start/Stop button. It has 8 Edit/Quick Edit Knobs for controlling and editing parameters and sending MIDI CC's, a (synth) Morph knob, a Sequencer Morph knob and a volume knob.

Pushing the **Trigger 1-16** buttons, with Func/Mute and Steps/Part unlit, will trigger the respective LD3 part. Each trigger button will send a settable note number (Settable in the Synth "Trig" section). When a trigger is triggered, the button will light up.

The **Start/Stop** button will start and stop Sequencer playback. When the sequencer is playing back, the Start/Stop button will light up.

The **Morph Set** button, will toggle the parameters on any Synth and Sequencer page, between 2 layers of parameters, A and B. The **Morph** knob (**MIDI CC#1**) will morph between the two layers of Synth parameters, and the **Seq Morph** knob (**MIDI CC#2**) will morph between the two layers of Sequencer parameters.

When the **Func/Mute** button is held down, it is possible to **mute/unmute** the 16 note tracks, by pushing any of the 16 step buttons. When it is lighting up, the 16 step buttons functions as **Quick Jump** buttons, that will take you to the edit pages, which names are showed right above each step button.

When the **Steps/Part** button is held down, the 16 step buttons functions as **Part Select** buttons. Pushing any of these, will select part 1 to 16.

When it is lighting up, the 16 step buttons will show the **steps** of the selected sequencer note track. Steps that are on will light up, steps that are off will not light.

The **Volume** knob always adjusts the audio output volume.

The **Edit 1-8 Knobs** to the left of the display, adjusts the parameters on each edit page. On the **Preset Select screen**, they acts as modulation sources, that controls any parameters that has knob1 to 8 set as modulator, and transmits MIDI CC's. Any Edit Knob, that has not been assigned as a modulator to any parameter, acts as a **Quick Edit Knob**.

The Quick Edit Knobs controls:

- Edit Knob 1: Digital filter 1 cutoff (**MIDI CC#4**).
- Edit Knob 2: Digital filter 1 resonance (**MIDI CC#5**).
- Edit Knob 3: Digital filter 1 mix (**MIDI CC#8**).
- Edit Knob 4: VCA envelope release time (**MIDI CC#9**).
- Edit Knob 5: Digital filter 2 cutoff (**MIDI CC#10**).
- Edit Knob 6: Digital filter 2 resonance (**MIDI CC#11**).
- Edit Knob 7: Digital filter 2 mix (**MIDI CC#12**).
- Edit Knob 8: The level of the selected part (**MIDI CC#7**).

When the knobs is not assigned to any modulation destinations, they will work as Quick Edit knobs. When they work as Quick Edit knobs, and MIDI CC's are received, these will be received **per part**.

When the Edit Knobs are assigned as modulation sources, to any modulation destination, they will work **globally**.

The Morph knob and the Seq Morph knob will always work globally.

The Touch Screen Keyboard

The LD3 display is touch sensitive. The touch interface is used for navigating through the edit and settings pages, and in the bottom of most pages, a fully playable touch keyboard is present.

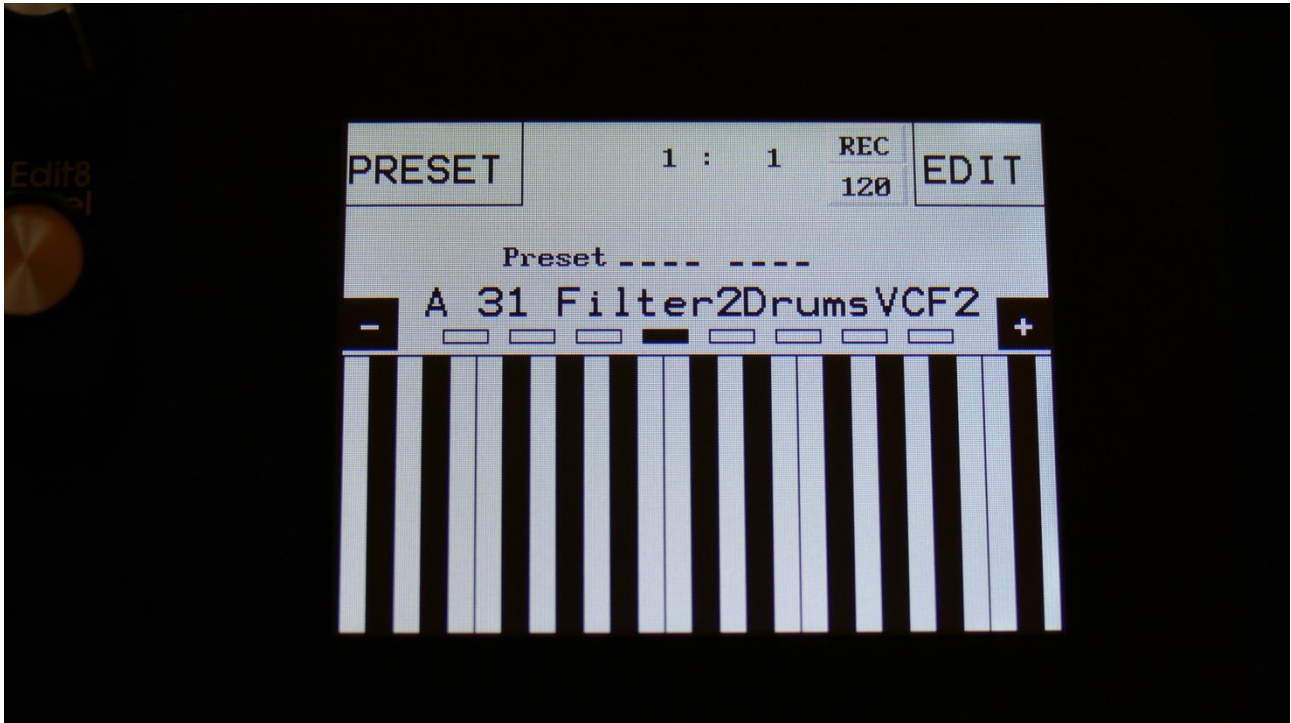

On the Preset and Song Select pages, it is, besides from playing notes on the touch keyboard, also possible to apply modulation to the sound, by placing your finger on different positions between the top and the bottom of the keyboard. This is referred to as Keyboard Y modulation. On any other pages, the keyboard only plays notes.

The touch keyboard is always controlling the selected part.

It is possible to select the keyboard octave, by touching any of the 8 squares just above the keyboard.

By touching the “-“ and “+“ buttons, just above the keyboard, it is possible to adjust the keyboard size. The size can be from 1 to 8 octaves.

The Y position modulation is transmitted, received and recorded as MIDI CC#16.

The Preset Select Screen

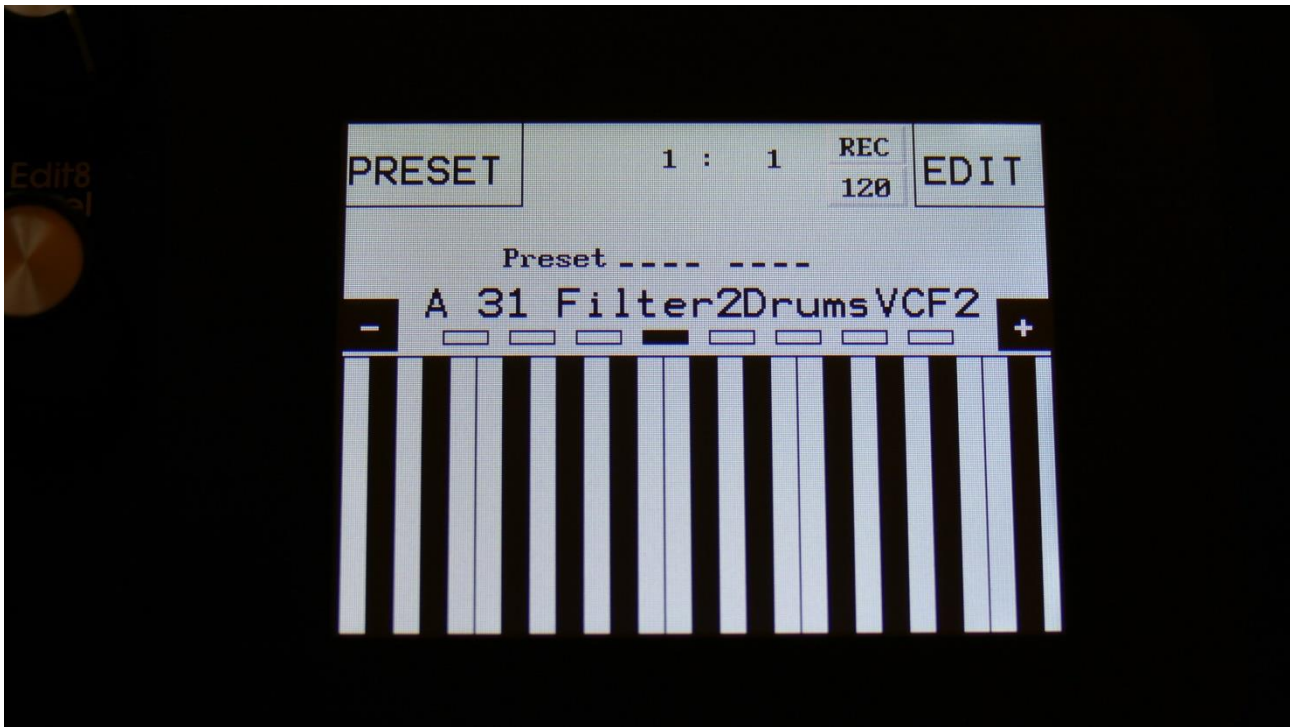

This is the first screen you will see, right after LD3's start-up screen, unless you left your LD3 in Song mode, the last time it was turned off. Here you can change preset, jump to LD3's edit and settings pages, and adjust the touch keyboard settings, as described on the previous pages.

On the top of this screen, the Sequencer bar/beat, that is currently being played back, is shown.

To the right of the bar/beat indicator, you will find a sequencer record indicator (REC) and a sequencer tempo indicator. When the REC indicator is red, the sequencer are in record mode. Touching the REC indicator, will switch the sequencer in and out of recording mode. Touching the tempo indicator, will make LD3 jump to the sequencer main page, where you can set the tempo. The tempo indicator will read "EXT", if LD3 is set to external MIDI sync.

Below the bar/beat indicator, it says "Preset", if LD3 is currently in preset mode, or "Song" if it is currently in song mode.

Below this, the number and name of the currently selected preset/song is shown.

Below the preset name/number, you will find the touch screen keyboard.

Right above the preset name, 8 small VU-meters are shown. These shows the activity of voice 1 to 8.

Touch the "EDIT" field in the upper right corner of the screen, to enter the edit and setup pages.

Touch the “PRESET” field, to select a memorized preset.

Selecting a preset:

Touch the “PRESET” field. A list of 5 presets near the currently selected preset, will now appear:

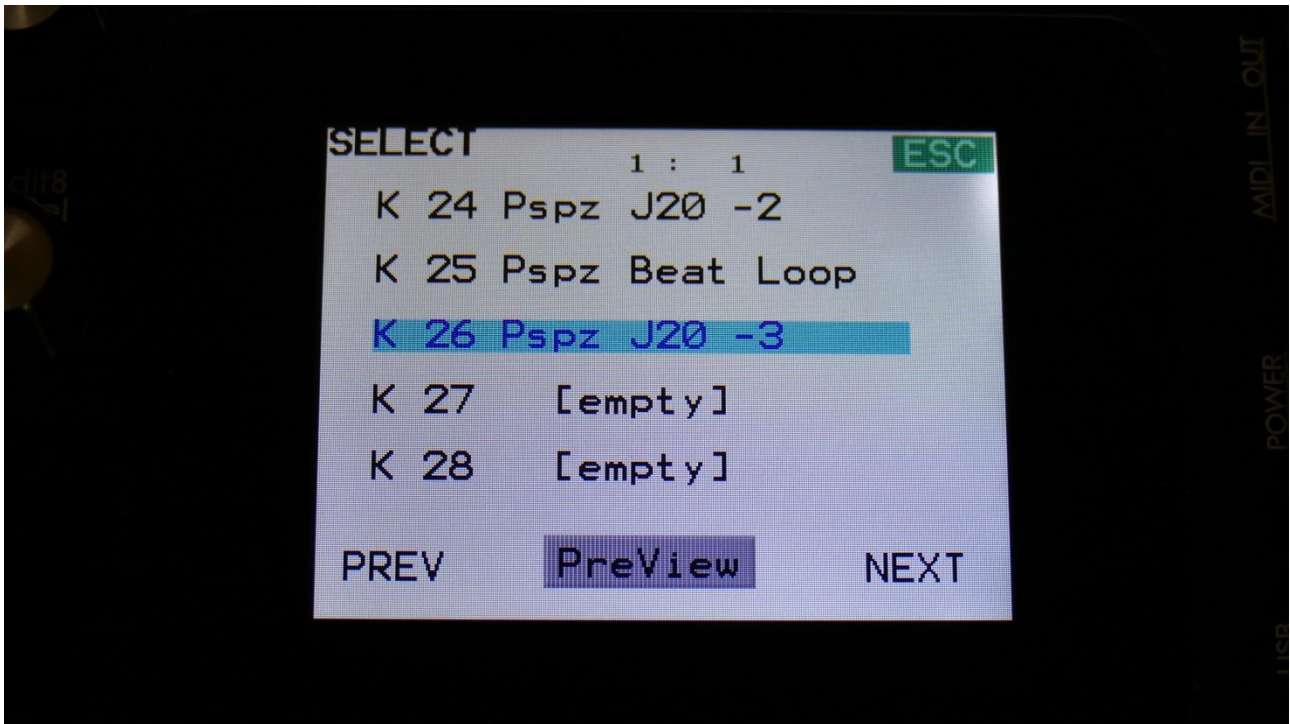

Touch “PREV” or “NEXT” to view the previous or next 5 presets, and finally touch the preset name of the preset you would like to select. 1024 presets can be selected, from A01 to P64.

LD3 will now jump back to the main Preset Select screen, and show the name of the newly selected preset.

If the sequencer is playing back, the Start/Stop LED will now start to flash, and the text “NEXT:” will show right above the new presets name, awaiting track 1 to reach its start/end step. As soon as this happens, LD3 will switch to the newly selected preset, the Start/Stop LED will stop flashing, and “NEXT:” will disappear.

If the sequencer is not playing back, LD3 will immediately switch to the new preset, when you touch the preset name.

When LD3 is turned off, it will remember which preset was selected, and start up with this, when turned on again. It will also remember if it was in preset or song mode, and start up in the same mode, and if it was in song mode, it will also remember which song was selected.

Presets can also be selected, using the buttons. This is described in the next section “Operating LD3”.

If you activate the PreView mode, by touching the PreView field, so it turns black with white text, you can preview the presets, without LD3 jumping back to the main Preset Select screen.

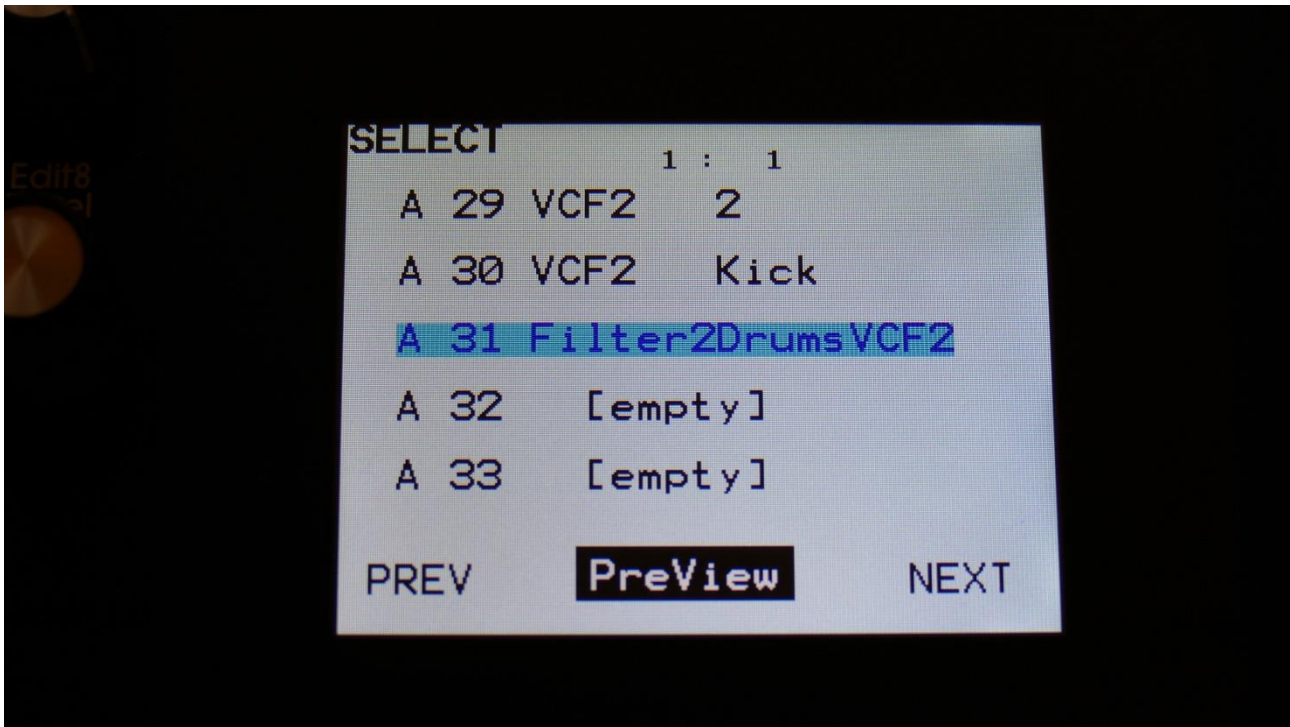

If the sequencer is running, it will still wait for track 1 to reach step 1, until it jumps to the next preset. This is indicated by the Start/Stop LED flashing.

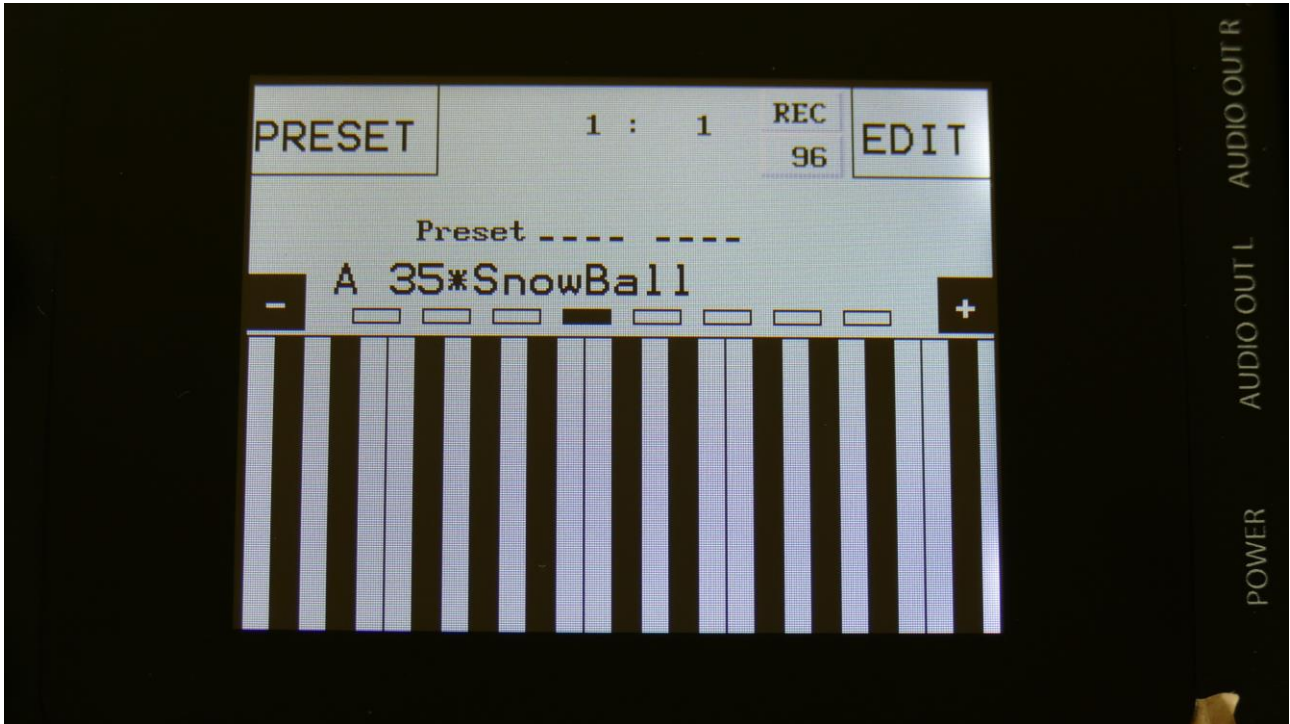

If any parameters of the preset has been edited, and the edits has not been stored, a “*” will appear right between the preset number and the preset name.

When this appears, you will need to save your preset, in order to keep your edits. Please see how to do this in the “Save Preset” section, later in this manual.

Operating LD3

Starting and stopping the Sequencer, and trigger parts manually:

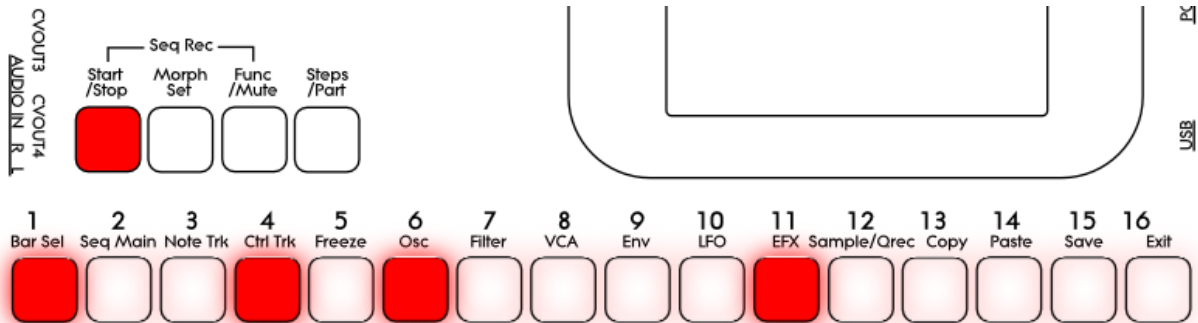

To start the sequencer playback, push and release the Start/Stop button, so that it lights up.

The sequencer will now start to play back. When the Func/Mute and the Steps/part buttons are not lighting up, every time a part is triggered to play back, the corresponding step button will light up shortly.

To stop the sequencer, simply hit the Start/Stop button again, so that it is no longer lighting up.

To trigger the 16 parts manually, make sure that neither the Func/Mute button or the Steps/Part button is lighting up, and then push any of the 16 step buttons, to trigger the sounds that are programmed on each part.

Selecting a part:

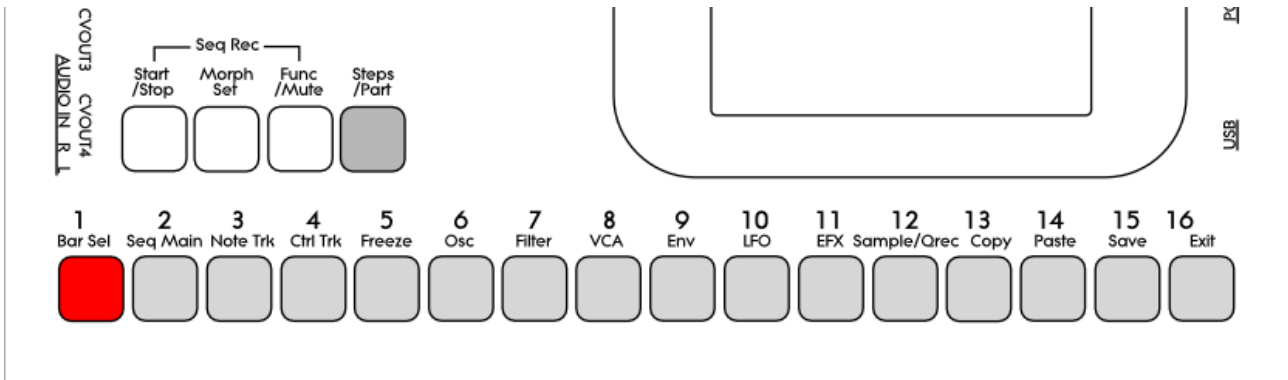

Push and hold the Steps/Part button.

The selected part number will now be shown, by one of the 16 step buttons lightning up. The number above the step button, is the part number that is currently selected.

To select another part, while still holding down the Steps/Part button, push any of the 16 step buttons.

The selected part, is the part which parameters will be shown on the display, when entering the edit pages.

Selecting a part, also selects the equally numbered Sequencer Note Track.

When entering the Sequencer Controller tracks 1 to 16, track 1 to 16 is selected in the same way.

When entering the Sequencer Controller tracks 17 to 32, 1 will equal 17, 2 will equal 18, and so on. The Sequencer Controller tracks are selected separately from the parts.

Selecting Effects Processors

The 8 insert effects processors and the 2 output effects processors are also selected, using the part select buttons.

Part 1 is insert effect 1

Part 2 is insert effect 2

Part 3 is insert effect 3

-

Part 8 is insert effect 8

Part 9 is output effect 1

Part 10 is output effect 2

Sequencer Note Track Steps view/edit:

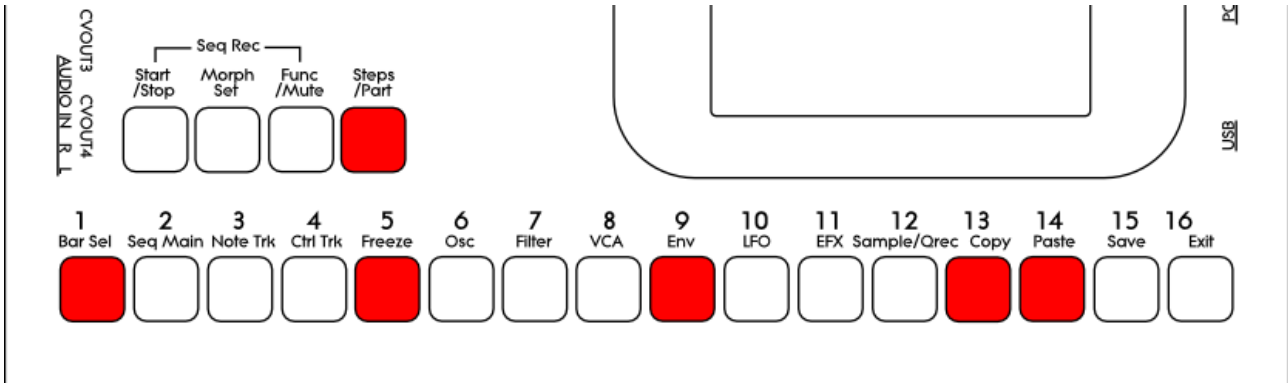

First, select the part, for which you would like to view/edit the note steps, as described earlier in this manual. You can, of course, select another part at any time, also after you have entered note step edit mode.

To enter note step edit mode, push and release the Steps/Part button. This should now light up. Any note sequencer steps that are switched on to play back, will now also light up on the 16 step buttons.

If the sequencer is running, the light state of each step button will be reversed, when a step is playing back.

To switch a step on or off, simply hit the corresponding step button, at it will toggle its state.

When the sequencer are in recording mode (the Start/Stop button is flashing), pushing any of the step buttons, will set record mode to step mode, and select this step for recording. The step button will now flash.

When using the LD3 sequencer as a usual step sequencer, the steps will play back from left to right. In this case, step 1 plays back at position 1, step 2 plays back at position 2 and so on. On the LD3 sequencer, it is though possible to break this pattern, and make each step play back on any position, using the position subtrack. It is even possible to make more steps playing back at the same position, for polyphonic step sequencing. But more on that in the final manual...

Only 16 steps are shown at a time. The note tracks of LD3 has 64 steps. Please read on, to experience how to switch between step 1-16, 17-32, 33-48 and 49-64.

Selecting Sequencer Note Track steps 1-16, 17-32, 33-48 and 49 to 64 / + Controller tracks steps 65-80, 81-96, 97-112, 113-128:

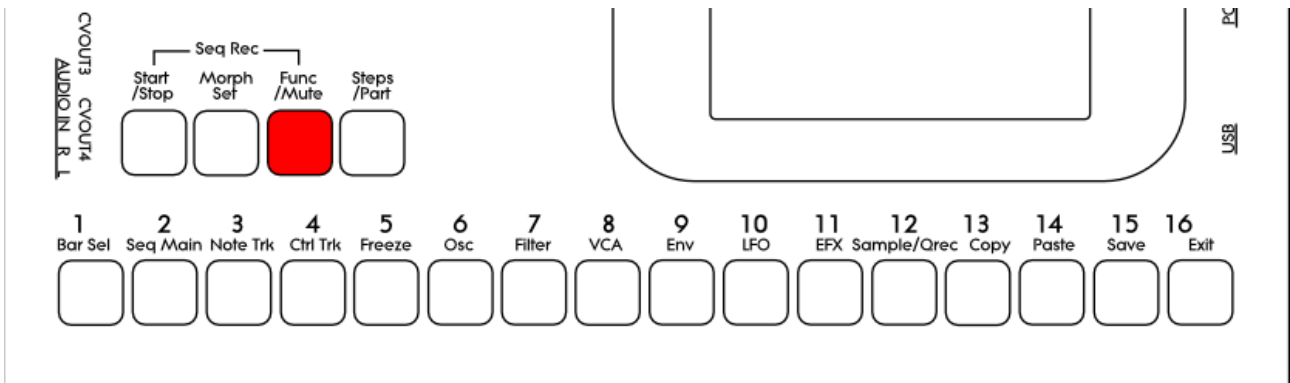

Push and release the **Func/Mute** button, so that it is lightning up. Now, push and release step button 1, **Bar Sel**:

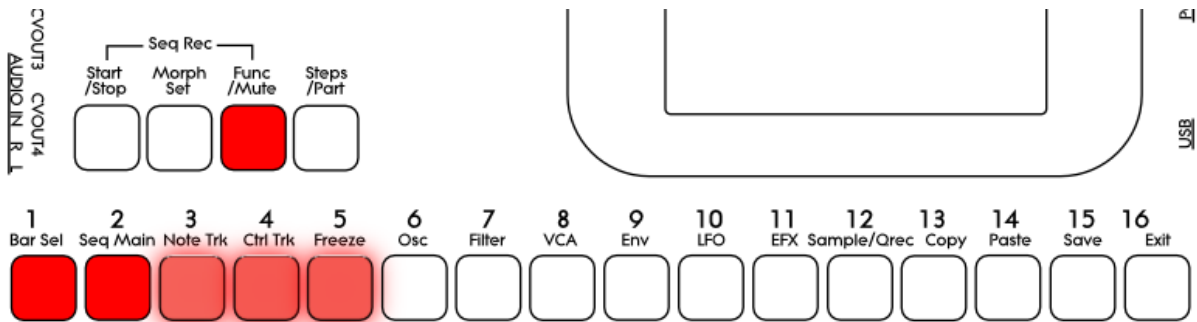

Now step button 1, **Bar Sel**, will light up.

Note tracks: When you are located on any other pages, than the sequencer controller tracks pages, bar is selected to be viewed for a note track. The selected bar, is the bar that is shown on the step buttons, and on the note track pages.

Hit Bar Sel, so that it lights up. Now step buttons 2 to 5 will select bar 1 to 4, of the currently selected track. The button of the bar that is selected, will light up. The other 3 bar select buttons will flash.

Controller tracks: When you are located on any of the controller track pages, bar is selected to be viewed for the currently selected controller track. The selected bar, is the bar that is shown on the controller track pages.

Hit Bar Sel, so that it lights up. Now step buttons 2 to 9 will select bar 1 to 8, of the currently selected track. The button of the bar that is selected, will light up. The other 7 bar select buttons will flash.

When pushing a bar button, that is already selected, both on note and controller tracks, the function of the Edit Knobs will now be toggled: Parameters > Knobs1-8 > Knobs 9-16.

Setting the last step of a Note Track

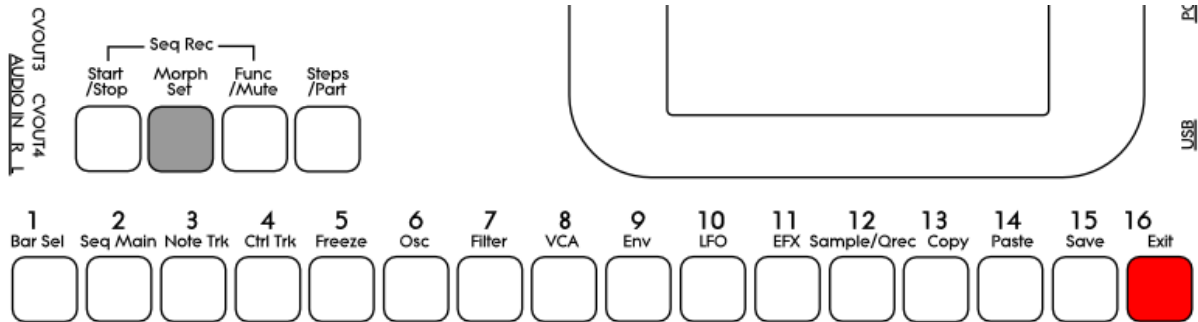

This can be done on the Note Tracks edit pages, but it can also be done via the pushbuttons.

Push and hold the Morph Set button. If the last step of the selected note track are inside the selected step range, this will now be shown, as a step button that lights up. Push any step button, while still holding down the Morph Set button, to set the last step of the selected Note Track.

Mute/Unmute Note Tracks:

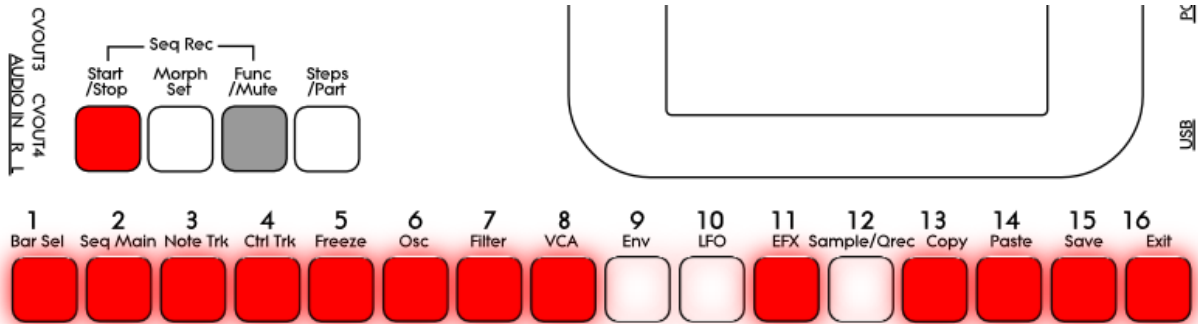

To mute, unmute or view the mute state of the 16 note tracks, push and hold the Func/Mute button.

Unmuted tracks will now be shown by a step button that is lighting up, and shortly flashes off, every time the track is triggering.

Muted tracks are shown by a step button that is unlit, and that lights up shortly, every time the track would have triggered something, if it weren't muted.

To mute or unmute a track, simply hit the corresponding step button, while still holding down the Func/Mute button.

Copy Morph Layer A to Layer B

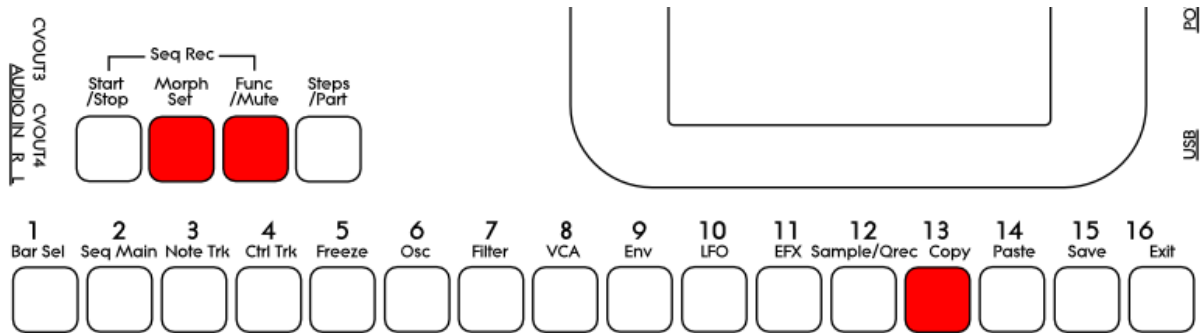

Push and release the Func/Mute button, so that it lights up, to enter the function buttons. Now push and release step button 13 (Copy), so that this also lights up. Instructions for copy and panic will now be shown on the screen. Push and release the Morph Set button. Morph layer A synth parts and sequencer parameters has now been copied to morph layer B. If you turn the Morph knobs, you should now hear the same sound/sequence, no matter what position the knobs are in.

Selecting the next preset

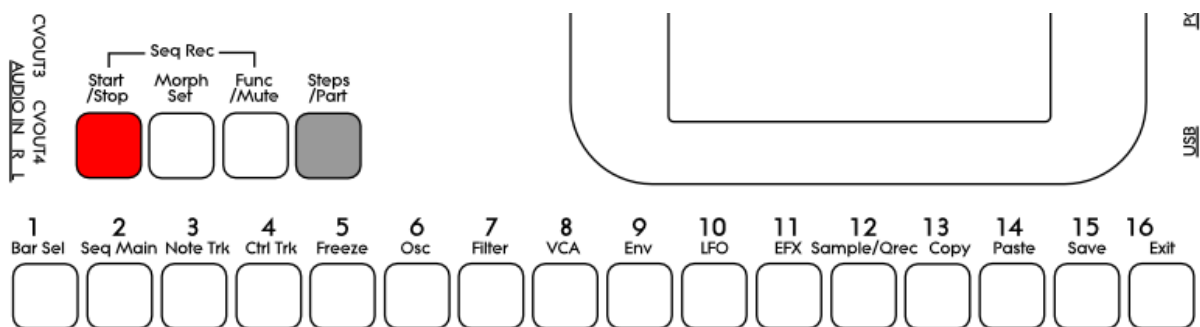

Push and hold the Steps/Part button while pressing the Start/Stop button. LD3 will now select the next preset. If the sequencer is playing back, the Start/Stop LED will now start to flash, and the text "NEXT:" will show right above the new presets name, awaiting track 1 to reach its start/end step. As soon as this happens, LD3 will switch to the newly selected preset, the Start/Stop LED will stop flashing, and "NEXT:" will disappear.

If the sequencer is not playing back, LD3 will immediately switch to the new preset.

Selecting the previous preset

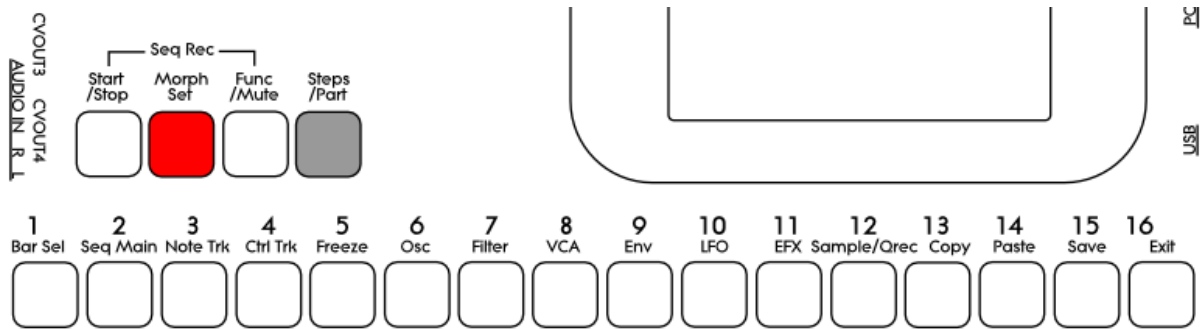

Push and hold the Steps/Part button while pressing the Morph/Set button. LD3 will now select the previous preset. If the sequencer is playing back, the Start/Stop LED will now start to flash, and the text "NEXT:" will show right above the new presets name, awaiting track 1 to reach its start/end step. As soon as this happens, LD3 will switch to the newly selected preset, the Start/Stop LED will stop flashing, and "NEXT:" will disappear.

If the sequencer is not playing back, LD3 will immediately switch to the new preset.

Selecting Presets using the step buttons

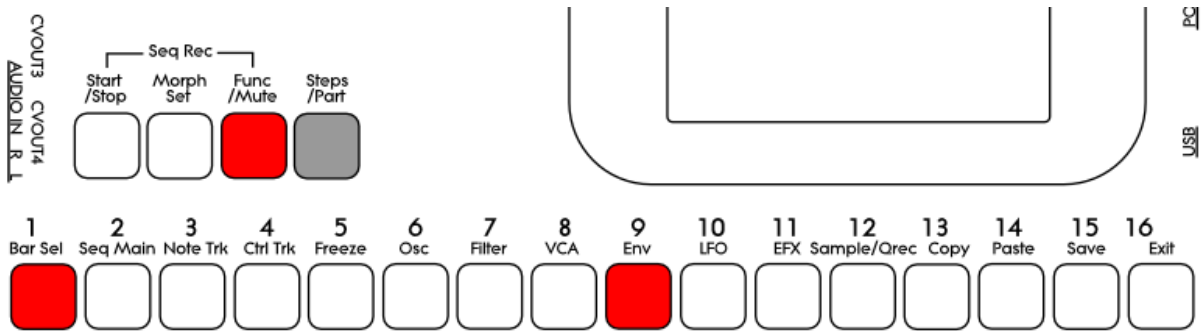

Push and hold the Steps/Part button while pressing the Func/Mute button. Now both of these buttons will light up.

It is now possible to select the 64 presets in the currently selected preset bank, using the step buttons. Step button 1 to 8 selects the lower digit of the preset number, and step button 9-16 selects the higher digit.

When pushing the same button combination again, the Steps/Part button will still light up, while the Func/Mute button will start to flash.

It is now possible to select preset bank A to P, using step buttons 1 to 16.

Pushing the same button combination yet another time, will exit from the preset select mode.

Preset Reload / Advance Song realtime record step

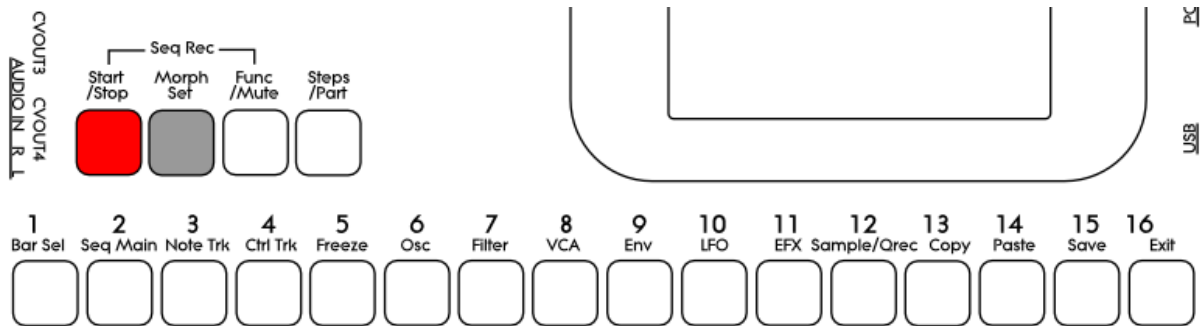

Push and hold the Morph Set button, while pressing the Start/Stop button, to reload the currently selected preset.

While realtime recording a song, reloading the preset, will cause the song recorder to advance to the next song step. This is useful for recording track mutes of the same preset into the song.

Panic

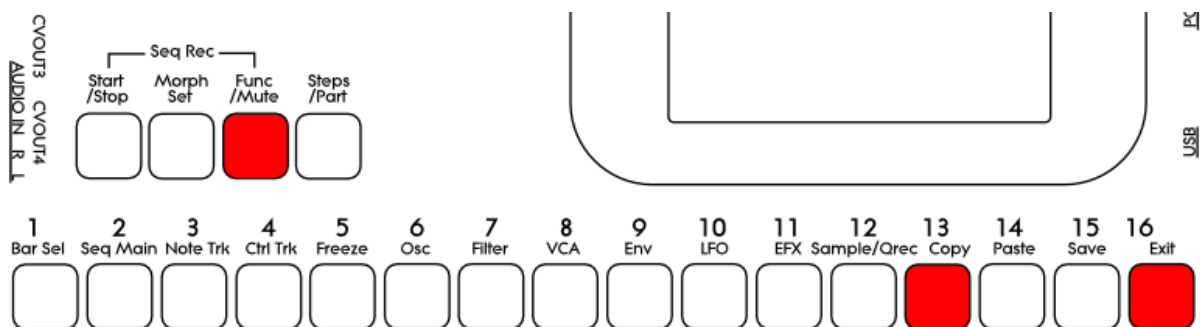

Push and release the Func/Mute button, so that it lights up, to enter the function buttons. Now push and release step button 13 (Copy), so that this also lights up. Instructions for copy and panic will now be shown on the screen. Push and release step button 16 (Exit).

Now all notes, both internally and on any MIDI devices connected to the LD3 MIDI out, will be shutted off.

Compare Edited Preset With Saved Preset

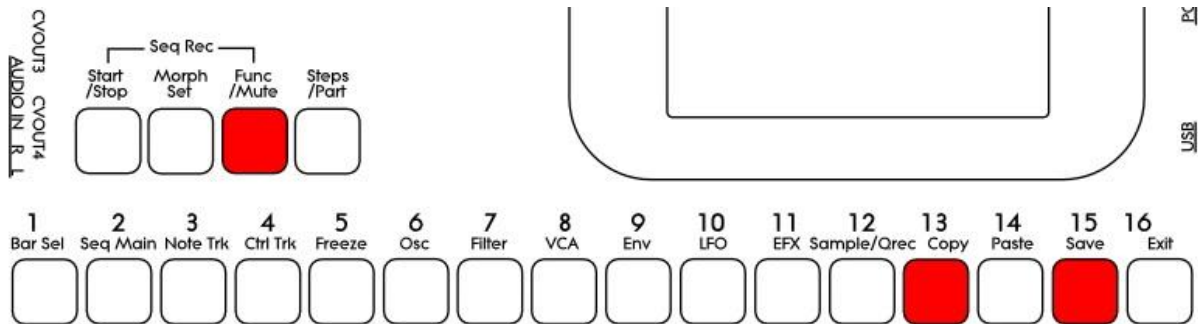

When you are editing a preset, and you would like to compare this with the originally saved preset, this is possible, using the Compare function.

To listen to the previously saved preset:

- Push and release the Func/Mute button, so that it lights up.
- Push and release step button 13 (Copy).
- Push and release step button 15 (Save).

You can now play with the previously saved preset.

To de-activate the Compare function, and jump back to the edited preset:

- Hit step button 15 (Save) again.

To de-activate the Compare function, and discard your edits:

- Hit step button 13 (Copy). The display will now show:

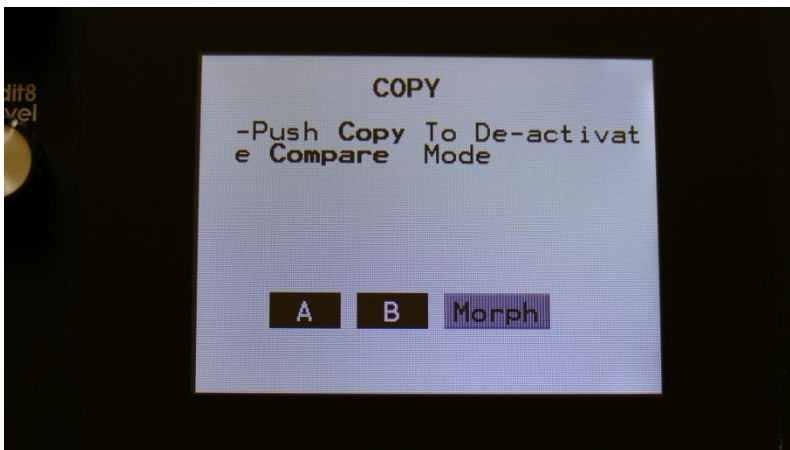

If you are absolutely sure, that you would like to discard your edits, hit step button 13 (Copy) again.

Shortcuts to Edit Pages

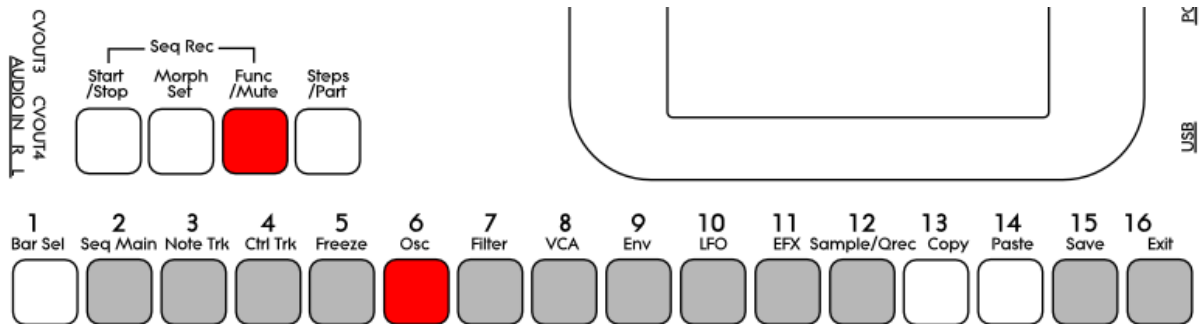

Push and release the Func/Mute button, so that it lights up. Now push and release the step button, that has the name of the edit page over it, that you wish to jump to. When pushing some of these buttons a number of times, it will toggle through a number of pages:

Seq Main: Sequencer Main.

Note Trk: Notes > Gate time > Velocity > Note Mod.

Ctrl Trk: Ctrl Track 1-16 step values > Ctrl Track 1-16 CC > Ctrl Track 17-32 step values > Ctrl Track 17-32 CC.

Freeze: Freezes any effects, that has Freeze modulation set to “Buton”.

Osc: Osc > Mod > Sel > Smp.

Filter: Digital filter 1 > Analog Filter 1 > Analog Filter 2 > Analog Filter 3 > Analog Filter 4.

VCA: VCA > Mod.

Env: Envelope > Mod.

LFO: LFO > Mod.

EFX: EFX Select > EFX > Mod.

Sample/Qrec: Sample Rec > Starts Quick recording > Stops Quick Recording and saves sampling.

Sample/Qrec and then Exit: Sample Edit.

Save: Save To Preset select > Save to name 1-8 > Save to name 9-16 > Saving Preset.

Exit: Exits from any page.

Audio Bus System

Each of the 16 parts in LD3, consists of a sound generator, that can be selected to be either a multi waveform oscillator, a sampler or a noise generator. The audio signal from the sound generator goes into 2 digital multimode filters. The output signal from the filters goes into a VCA.

In order to make the sound of the part audible, it must be assigned to one of the 8 audio busses. The audio bus must also be sent to an audio output, or output effects processor 1 or 2.

In the VCA section of the part, it is possible to assign the selected part to output to one or two audio busses. When outputting to two audio busses, the output signal from the part will be a stereo signal, and one of the two digital filters will be placed on the left channel, and the other on the right channel.

The default settings is that all parts are mono routed to Bus 1. Bus 1 is set to output on the main Left and Right audio jack connectors.

On each of the 8 busses, it is possible to place any of the 8 insert effect processors and the analog filters (up to 4, if installed), for processing the sounds, that are sent to the busses.

Each audio input can also be routed to any Bus, for realtime processing of external gear through the effects and analog filters.

The parameters of the audio busses, the parts and the effects are explained in the next section "The Synth/Sampler Parts".

The structure of the parts and busses in LD3, are shown on the next page.

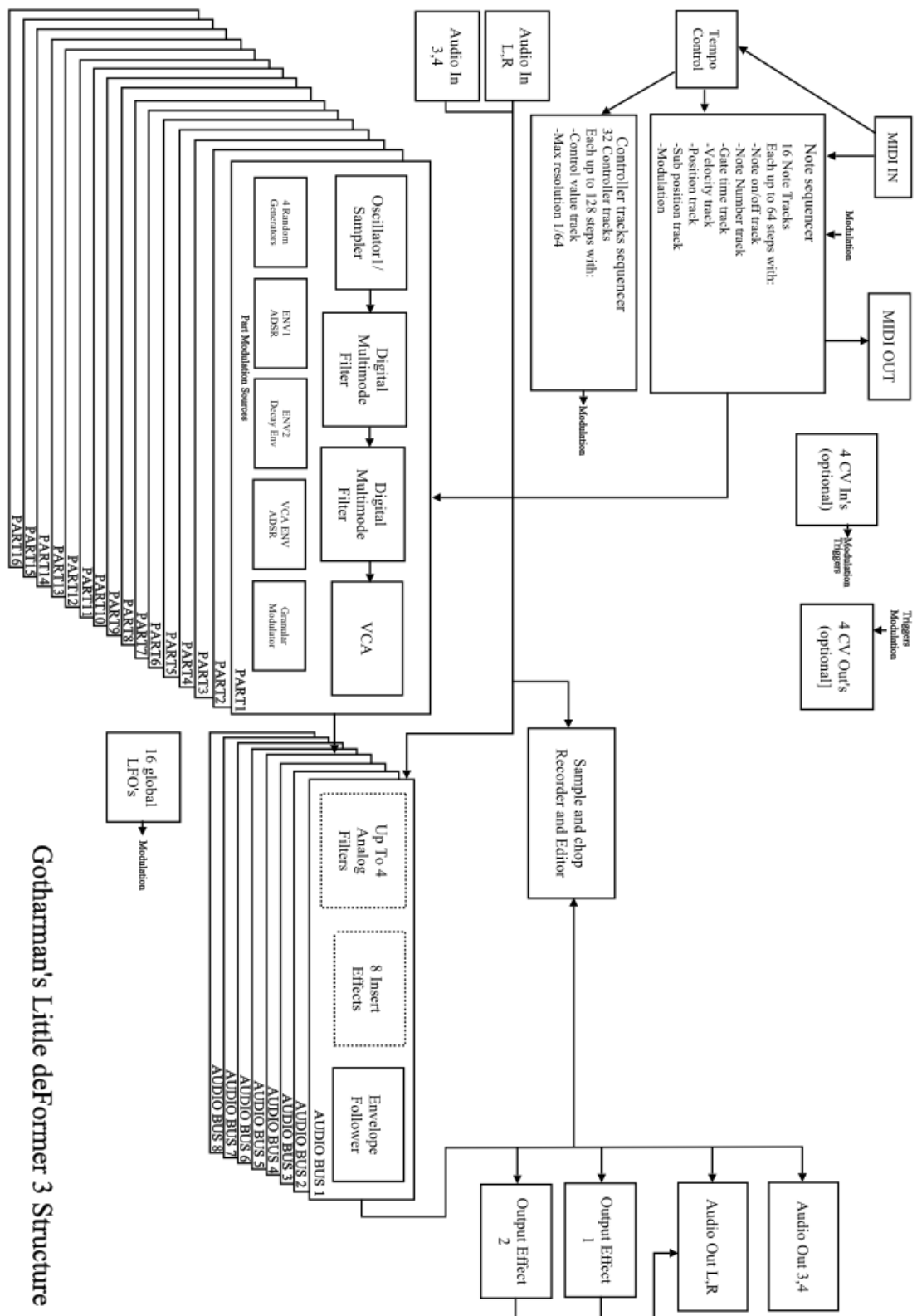

Gotharman's Little deFormer 3 Structure

The Synth/Sampler Parts

LD3 has 16 parts, that is playing back through 8 voices, using dynamic allocation.

Each part must be set up to output to one or two of the 8 audio busses (see the “Audio Bus System” section earlier in this manual).

Each part has:

-1 oscillator. This can play a morphable synth waveform, up to 4 samplings (stereo or mono, Xfade mode) or a noise waveform.

-2 digital multimode filters with resonance.

-1 VCA, where both output level and pan can be adjusted and modulated.

-3 envelopes. Two ADSR types and one decay envelope.

-4 Random Generators. Always key triggered.

-2 Granular Modulators. A random one and a sequenced one. Both are triggered, when a synth waveform or a sampling starts over.

Shared between the 16 parts:

-16 LFO's with morphable waveforms.

Audio busses:

The audio output of the parts can be sent to any of 8 audio busses. Each part can output to 2 audio busses at a time.

On the audio busses effects and analog filters can be applied, and the audio output of the busses can be sent to the 2 output effects, and to the audio outputs.

Remember to save all edits you do in the synth/sampler section. Else they will be lost when you change preset, or turn LD3 off. See how to in the “Save Preset” section.

List of Modulation Sources:

Env1: The output of ADSR Envelope 1

Env1-: The output of ADSR Envelope 1 Inverted

Env2: The output of Decay Envelope 2

Env2-: The output of Decay Envelope 2 Inverted

Aenv: The output of the VCA Envelope

Aenv-: The output of the VCA Envelope Inverted

LFO1: The output of LFO1

LFO1-: The output of LFO1 Inverted

LFO2: The output of LFO2

LFO2-: The output of LFO2 Inverted

LFO3: The output of LFO3

LFO3-: The output of LFO3 Inverted

LFO4: The output of LFO4

LFO4-: The output of LFO4 Inverted

LFO5: The output of LFO5

LFO5-: The output of LFO5 Inverted

LFO6: The output of LFO6

LFO6-: The output of LFO6 Inverted

LFO7: The output of LFO7

LFO7-: The output of LFO7 Inverted

LFO8: The output of LFO8

LFO8-: The output of LFO8 Inverted

LFO9: The output of LFO9

LFO9-: The output of LFO9 Inverted

LFO10: The output of LFO10

LFO10-: The output of LFO10 Inverted

LFO11: The output of LFO11

LFO11-: The output of LFO11 Inverted

LFO12: The output of LFO12

LFO12-: The output of LFO12 Inverted

LFO13: The output of LFO13

LFO13-: The output of LFO13 Inverted

LFO14: The output of LFO14

LFO14-: The output of LFO14 Inverted

LFO15: The output of LFO15

LFO15-: The output of LFO15 Inverted

LFO16: The output of LFO16
LFO16-: The output of LFO16 Inverted
Rnd1: The output of Part Random Generator 1
Rnd1-: The output of Part Random Generator 1 Inverted
Seq1: The output of Sequencer Controller Track 1
Seq1-: The output of Sequencer Controller Track 1 Inverted
Seq2: The output of Sequencer Controller Track 2
Seq2-: The output of Sequencer Controller Track 2 Inverted
Seq3: The output of Sequencer Controller Track 3
Seq3-: The output of Sequencer Controller Track 3 Inverted
Seq4: The output of Sequencer Controller Track 4
Seq4-: The output of Sequencer Controller Track 4 Inverted
Seq5: The output of Sequencer Controller Track 5
Seq5-: The output of Sequencer Controller Track 5 Inverted
Seq6: The output of Sequencer Controller Track 6
Seq6-: The output of Sequencer Controller Track 6 Inverted
Seq7: The output of Sequencer Controller Track 7
Seq7-: The output of Sequencer Controller Track 7 Inverted
Seq8: The output of Sequencer Controller Track 8
Seq8-: The output of Sequencer Controller Track 8 Inverted
Seq9: The output of Sequencer Controller Track 9
Seq9-: The output of Sequencer Controller Track 9 Inverted
Seq10: The output of Sequencer Controller Track 10
Seq10-: The output of Sequencer Controller Track 10 Inverted
Seq11: The output of Sequencer Controller Track 11
Seq11-: The output of Sequencer Controller Track 11 Inverted
Seq12: The output of Sequencer Controller Track 12
Seq12-: The output of Sequencer Controller Track 12 Inverted
Seq13: The output of Sequencer Controller Track 13
Seq13-: The output of Sequencer Controller Track 13 Inverted
Seq14: The output of Sequencer Controller Track 14
Seq14-: The output of Sequencer Controller Track 14 Inverted
Seq15: The output of Sequencer Controller Track 15
Seq15-: The output of Sequencer Controller Track 15 Inverted
Seq16: The output of Sequencer Controller Track 16
Seq16-: The output of Sequencer Controller Track 16 Inverted
Seq17: The output of Sequencer Controller Track 17
Seq17-: The output of Sequencer Controller Track 17 Inverted
Seq18: The output of Sequencer Controller Track 18
Seq18-: The output of Sequencer Controller Track 18 Inverted

Seq19: The output of Sequencer Controller Track 19
Seq19-: The output of Sequencer Controller Track 19 Inverted
Seq20: The output of Sequencer Controller Track 20
Seq20-: The output of Sequencer Controller Track 20 Inverted
Seq21: The output of Sequencer Controller Track 21
Seq21-: The output of Sequencer Controller Track 21 Inverted
Seq22: The output of Sequencer Controller Track 22
Seq22-: The output of Sequencer Controller Track 22 Inverted
Seq23: The output of Sequencer Controller Track 23
Seq23-: The output of Sequencer Controller Track 23 Inverted
Seq24: The output of Sequencer Controller Track 24
Seq24-: The output of Sequencer Controller Track 24 Inverted
Seq25: The output of Sequencer Controller Track 25
Seq25-: The output of Sequencer Controller Track 25 Inverted
Seq26: The output of Sequencer Controller Track 26
Seq26-: The output of Sequencer Controller Track 26 Inverted
Seq27: The output of Sequencer Controller Track 27
Seq27-: The output of Sequencer Controller Track 27 Inverted
Seq28: The output of Sequencer Controller Track 28
Seq28-: The output of Sequencer Controller Track 28 Inverted
Seq29: The output of Sequencer Controller Track 29
Seq29-: The output of Sequencer Controller Track 29 Inverted
Seq30: The output of Sequencer Controller Track 30
Seq30-: The output of Sequencer Controller Track 30 Inverted
Seq31: The output of Sequencer Controller Track 31
Seq31-: The output of Sequencer Controller Track 31 Inverted
Seq32: The output of Sequencer Controller Track 32
Seq32-: The output of Sequencer Controller Track 32 Inverted
Kybd: The last note number value received for the part
Kybd-: The last note number value received for the part Inverted
Velo: The last note velocity value received for the part
Velo-: The last note velocity value received for the part Inverted
Maft: The last mono aftertouch value received for the part
Maft-: The last mono aftertouch value received for the part Inverted
Bnd: The last pitch bend value received for the part
Bnd-: The last pitch bend value received for the part Inverted
Knb1: Edit knob 1 value or the last MIDI CC 4 value received
Knb1-: Edit knob 1 value or the last MIDI CC 4 value received Inverted
Knb2: Edit knob 2 value or the last MIDI CC 5 value received
Knb2-: Edit knob 2 value or the last MIDI CC 5 value received Inverted

Kn3: Edit knob 3 value or the last MIDI CC 8 value received
Kn3-: Edit knob 3 value or the last MIDI CC 8 value received Inverted
Kn4: Edit knob 4 value or the last MIDI CC 9 value received
Kn4-: Edit knob 4 value or the last MIDI CC 9 value received Inverted
TouY: Touch screen keyboard Y-axis position
TouY-: Touch screen keyboard Y-axis position Inverted
GrRn: Granular Random Modulator
GrRn-: Granular Random Modulator Inverted
GrSq: Granular Sequenced Modulator
GrSq-: Granular Sequenced Modulator Inverted
CV1: The voltage applied to CV Input 1
CV1-: The voltage applied to CV Input 1 Inverted
CV2: The voltage applied to CV Input 2
CV2-: The voltage applied to CV Input 2 Inverted
CV3: The voltage applied to CV Input 3
CV3-: The voltage applied to CV Input 3 Inverted
CV4: The voltage applied to CV Input 4
CV4-: The voltage applied to CV Input 4 Inverted
Flw1: The Audio Bus 1 Envelope Follower
Flw1-: The Audio Bus 1 Envelope Follower Inverted
Flw2: The Audio Bus 2 Envelope Follower
Flw2-: The Audio Bus 2 Envelope Follower Inverted
Flw3: The Audio Bus 3 Envelope Follower
Flw3-: The Audio Bus 3 Envelope Follower Inverted
Flw4: The Audio Bus 4 Envelope Follower
Flw4-: The Audio Bus 4 Envelope Follower Inverted
Flw5: The Audio Bus 5 Envelope Follower
Flw5-: The Audio Bus 5 Envelope Follower Inverted
Flw6: The Audio Bus 6 Envelope Follower
Flw6-: The Audio Bus 6 Envelope Follower Inverted
Flw7: The Audio Bus 7 Envelope Follower
Flw7-: The Audio Bus 7 Envelope Follower Inverted
Flw8: The Audio Bus 8 Envelope Follower
Flw8-: The Audio Bus 8 Envelope Follower Inverted
Kn5: Edit knob 5 value or the last MIDI CC 10 value received
Kn5-: Edit knob 5 value or the last MIDI CC 10 value received Inverted
Kn6: Edit knob 6 value or the last MIDI CC 11 value received
Kn6-: Edit knob 6 value or the last MIDI CC 11 value received Inverted
Kn7: Edit knob 7 value or the last MIDI CC 12 value received
Kn7-: Edit knob 7 value or the last MIDI CC 12 value received Inverted

Knob8: Edit knob 8 value or the last MIDI CC 7 value received
Knob8-: Edit knob 8 value or the last MIDI CC 7 value received Inverted
Trig: The trigger output of the part
Trig-: The trigger output of the part Inverted
Rnd2: The output of Part Random Generator 2
Rnd2-: The output of Part Random Generator 2 Inverted
Rnd3: The output of Part Random Generator 3
Rnd3-: The output of Part Random Generator 3 Inverted
Rnd4: The output of Part Random Generator 4
Rnd4-: The output of Part Random Generator 4 Inverted
CC17: The last MIDI CC 17 value received
CC17-: The last MIDI CC 17 value received Inverted
CC18: The last MIDI CC 18 value received
CC18-: The last MIDI CC 18 value received Inverted
CC19: The last MIDI CC 19 value received
CC19-: The last MIDI CC 19 value received Inverted
CC20: The last MIDI CC 20 value received
CC20-: The last MIDI CC 20 value received Inverted
CC21: The last MIDI CC 21 value received
CC21-: The last MIDI CC 21 value received Inverted
CC22: The last MIDI CC 22 value received
CC22-: The last MIDI CC 22 value received Inverted
CC23: The last MIDI CC 23 value received
CC23-: The last MIDI CC 23 value received Inverted
CC24: The last MIDI CC 24 value received
CC24-: The last MIDI CC 24 value received Inverted
CC25: The last MIDI CC 25 value received
CC25-: The last MIDI CC 25 value received Inverted
CC26: The last MIDI CC 26 value received
CC26-: The last MIDI CC 26 value received Inverted
CC27: The last MIDI CC 27 value received
CC27-: The last MIDI CC 27 value received Inverted
CC28: The last MIDI CC 28 value received
CC28-: The last MIDI CC 28 value received Inverted
CC29: The last MIDI CC 29 value received
CC29-: The last MIDI CC 29 value received Inverted
CC30: The last MIDI CC 30 value received
CC30-: The last MIDI CC 30 value received Inverted
CC31: The last MIDI CC 31 value received
CC31-: The last MIDI CC 31 value received Inverted

CC33: The last MIDI CC 33 value received
CC33-: The last MIDI CC 33 value received Inverted
CC34: The last MIDI CC 34 value received
CC34-: The last MIDI CC 34 value received Inverted
CC35: The last MIDI CC 35 value received
CC35-: The last MIDI CC 35 value received Inverted
CC36: The last MIDI CC 36 value received
CC36-: The last MIDI CC 36 value received Inverted
CC37: The last MIDI CC 37 value received
CC37-: The last MIDI CC 37 value received Inverted
CC38: The last MIDI CC 38 value received
CC38-: The last MIDI CC 38 value received Inverted
CC39: The last MIDI CC 39 value received
CC39-: The last MIDI CC 39 value received Inverted
CC40: The last MIDI CC 40 value received
CC40-: The last MIDI CC 40 value received Inverted
CC41: The last MIDI CC 41 value received
CC41-: The last MIDI CC 41 value received Inverted
CC42: The last MIDI CC 42 value received
CC42-: The last MIDI CC 42 value received Inverted
CC43: The last MIDI CC 43 value received
CC43-: The last MIDI CC 43 value received Inverted
CC44: The last MIDI CC 44 value received
CC44-: The last MIDI CC 44 value received Inverted
CC45: The last MIDI CC 45 value received
CC45-: The last MIDI CC 45 value received Inverted
CC46: The last MIDI CC 46 value received
CC46-: The last MIDI CC 46 value received Inverted
CC47: The last MIDI CC 47 value received
CC47-: The last MIDI CC 47 value received Inverted
CC48: The last MIDI CC 48 value received
CC48-: The last MIDI CC 48 value received Inverted
CC49: The last MIDI CC 49 value received
CC49-: The last MIDI CC 49 value received Inverted
CC50: The last MIDI CC 50 value received
CC50-: The last MIDI CC 50 value received Inverted
CC51: The last MIDI CC 51 value received
CC51-: The last MIDI CC 51 value received Inverted
CC52: The last MIDI CC 52 value received
CC52-: The last MIDI CC 52 value received Inverted

CC53: The last MIDI CC 53 value received
CC53-: The last MIDI CC 53 value received Inverted
CC54: The last MIDI CC 54 value received
CC54-: The last MIDI CC 54 value received Inverted
CC55: The last MIDI CC 55 value received
CC55-: The last MIDI CC 55 value received Inverted
CC56: The last MIDI CC 56 value received
CC56-: The last MIDI CC 56 value received Inverted
CC57: The last MIDI CC 57 value received
CC57-: The last MIDI CC 57 value received Inverted
CC58: The last MIDI CC 58 value received
CC58-: The last MIDI CC 58 value received Inverted
CC59: The last MIDI CC 59 value received
CC59-: The last MIDI CC 59 value received Inverted
CC60: The last MIDI CC 60 value received
CC60-: The last MIDI CC 60 value received Inverted
CC61: The last MIDI CC 61 value received
CC61-: The last MIDI CC 61 value received Inverted

Accessing The Synth Part Pages

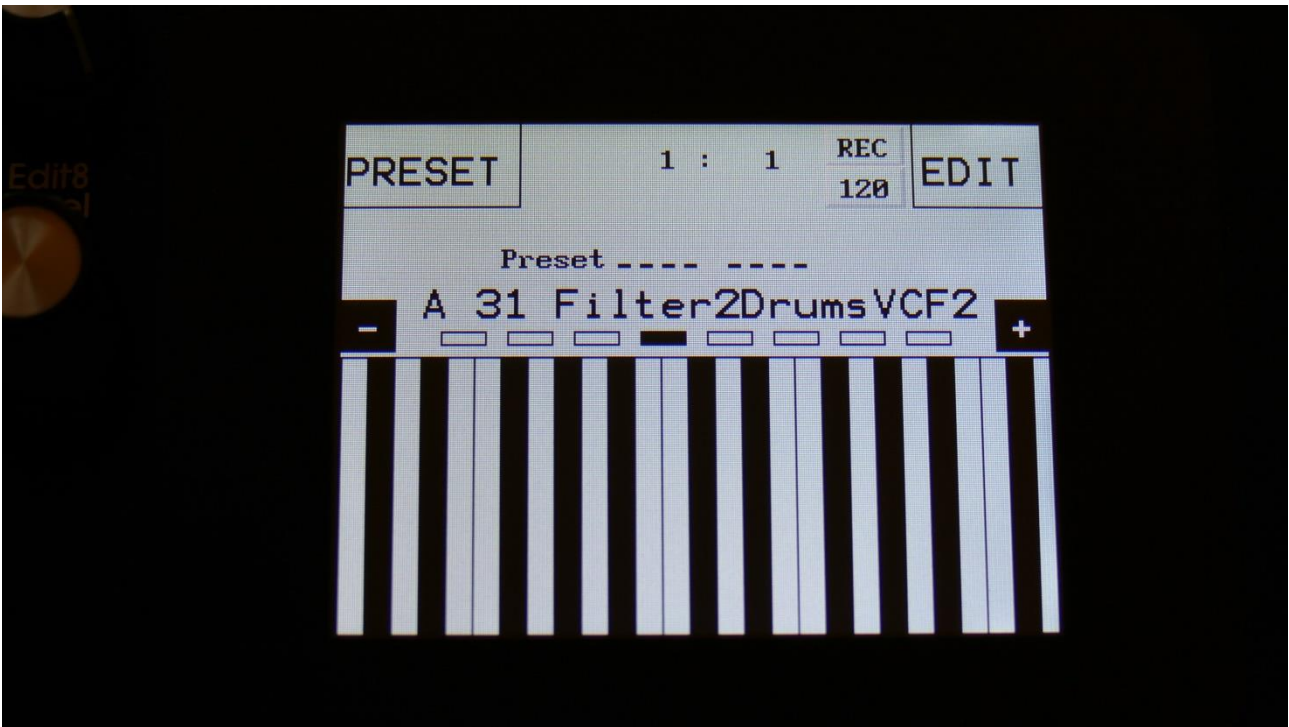

From the Preset/Song Select screen, touch the “EDIT” field.

Now LD3 will show the main Synth page:

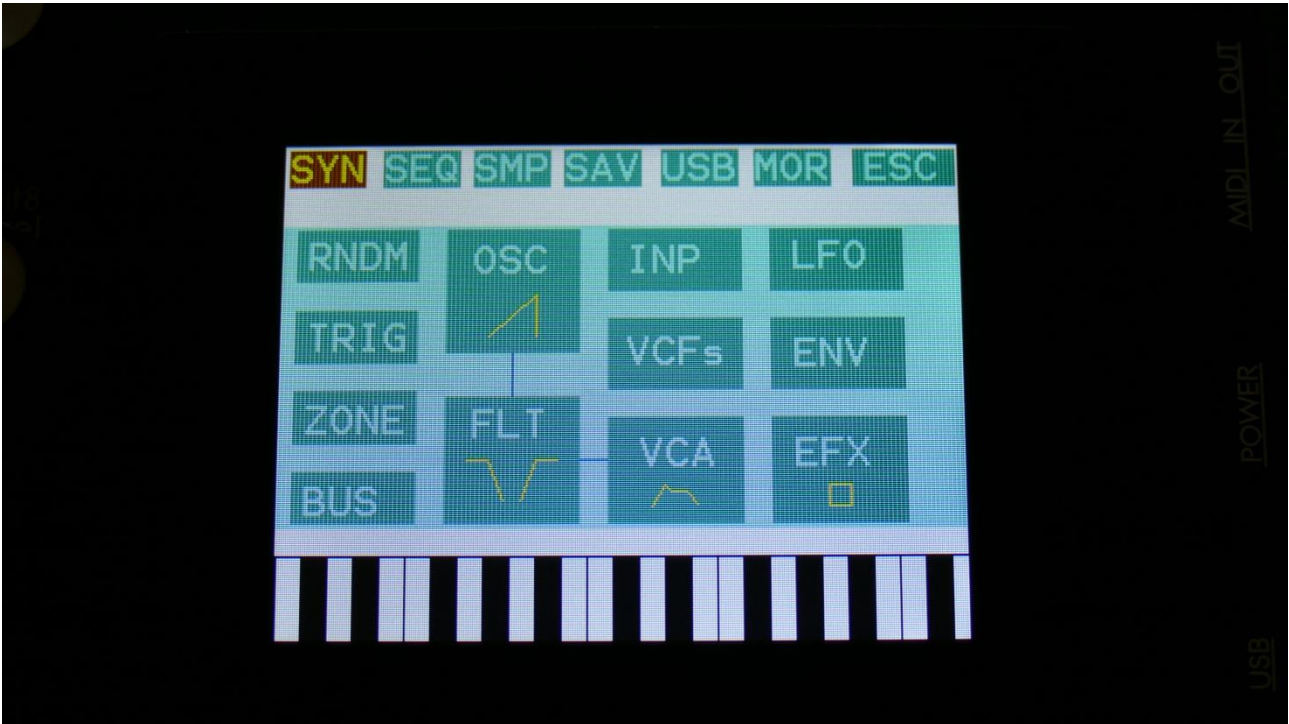

In the top of the main Synth page, you will find the 6 main edit groups and the ESC (escape) touch button. Touch any of these group buttons to access them, and touch ESC, to exit to the Preset Select page.

The touch button of the currently selected edit group is brown/yellow, while the buttons of the other groups are green.

The group of touch buttons, will be referred to as the “group select bar”.

Below the group select bar, you will find the synth blocks. Touch any block, to access the parameters of it, and edit these. Part 1 to 16 is selected using the Steps/Part button in combination with the step buttons.

In the bottom of this page, the touch keyboard is located.

The Synth Part pages can also be accessed, using pushbutton shortcuts. This is explained on page 36 of this manual.

Editing The Parameters Of The Synth Part Blocks

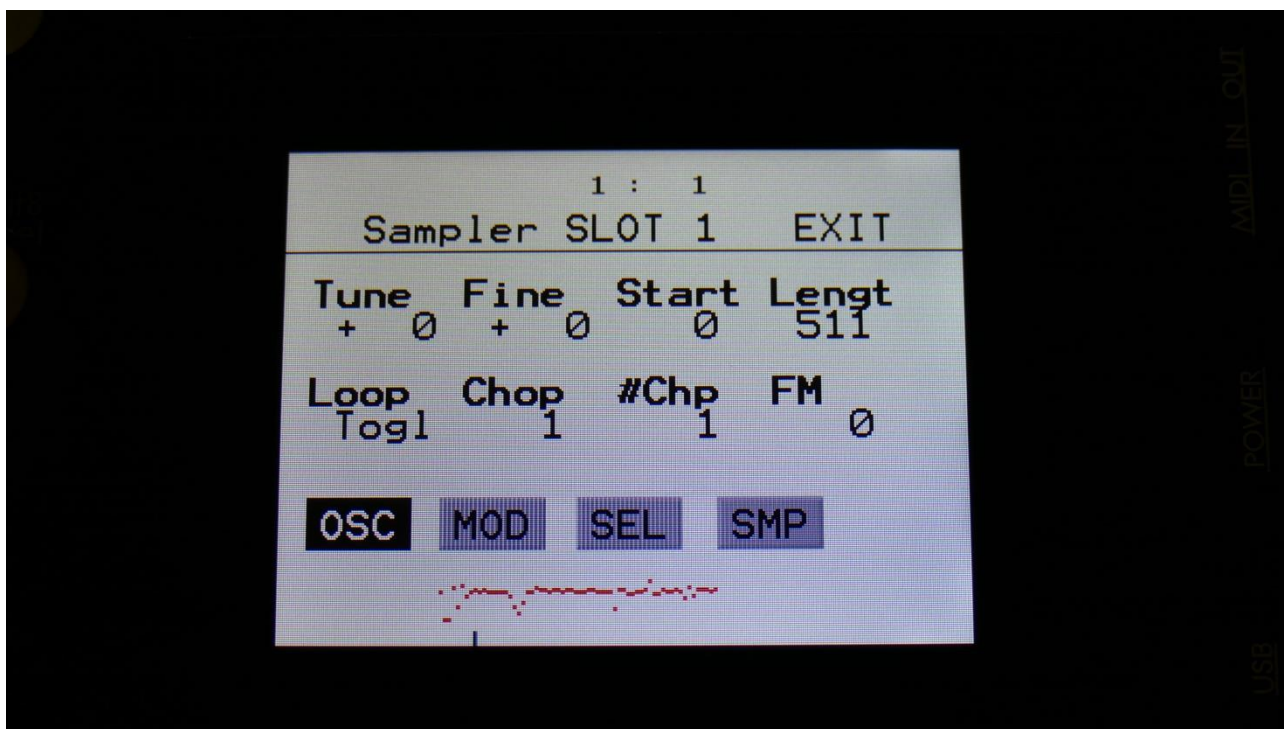

Each edit page has up to 8 parameters, that can be edited. The parameters are shown on the display as 8 parameter names, each with an alphanumeric value below them, that shows the current value of the parameter.

When turning any of the 8 Edit Knobs, the corresponding parameter will be adjusted, and you will hear a change in the sound, if the block is active.

Right below the parameters, you will find the subpage select touch buttons. Touch any of these, to access the desired parameter sub page. The touch button that is black with white text, shows that this is the currently selected sub page. The grey touch buttons, are the sub pages, that you can select.

In the top of the display, it is, on the part edit pages, possible to see what part slot that is currently selected.

In the upper right corner of each block you will find "EXIT". Touch this to exit to the main Synth page.

The Synth Part Blocks

In this section of the manual, you will find a description of the parameters of each part, and the parameters related to the LFO's the effects processors and the BUS system.

The Synth Part Parameters Randomizer

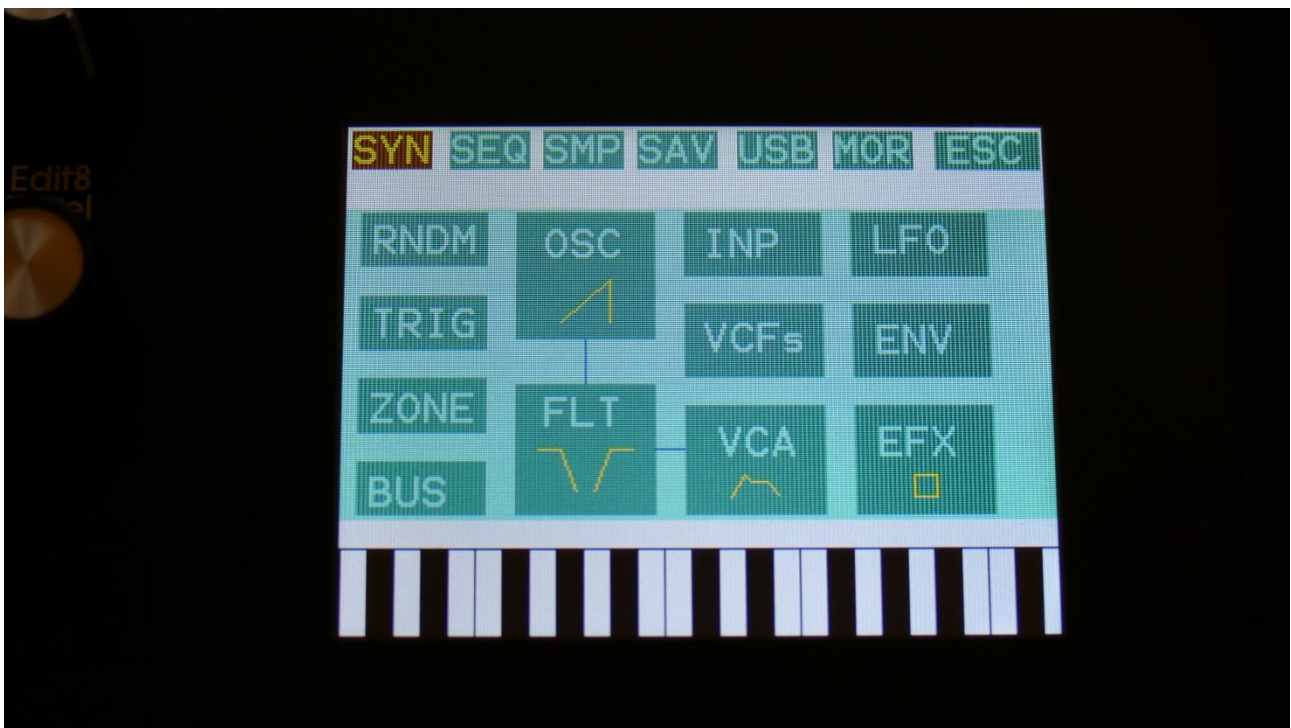

If you should ever need some new inspiration for sounds, or if you just want to surprise yourself with some sounds that you never even imagined, the LD3 parameter randomizer might be exactly what you need.

To enter this, from the synth parts main page, touch RNDM.

You should now enter this page:

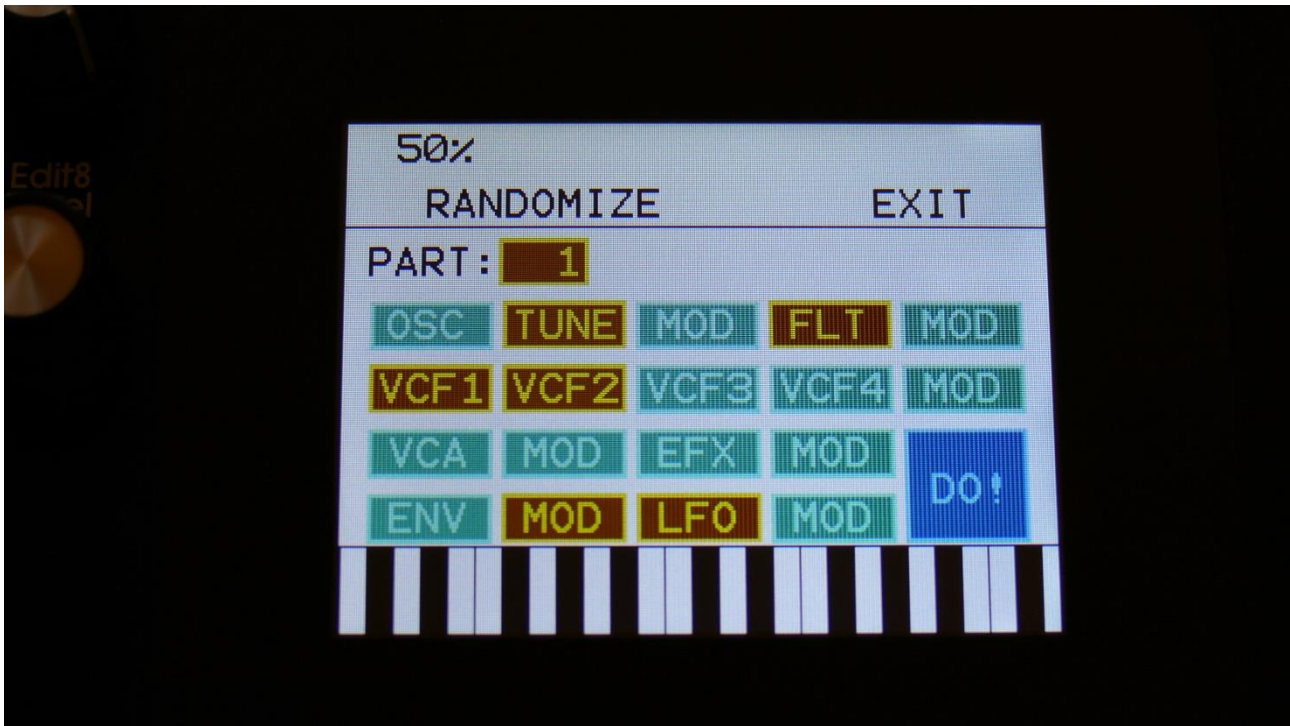

Select the part that you would like to randomize, in the same way as you would usually select a part, by pushing and holding the Steps/Part button, while pressing one of the 16 step buttons. Switch the blocks on, that you would like to randomize, simply by touching these, adjust the percentage, that it must maximum change the parameters, using Edit Knob 1, and hit “DO!”.

Green blocks are not randomized, brown blocks are.

Listen to the result.

If you like it, exit the randomizer page, and save the preset.

If you don't like the result, hit “DO!” again, and keep hitting it, until something comes up, that you like. Try with different percentage settings, and try to switch different blocks on and off.

When the Randomizer page is entered, all parameters are stored into a temporary buffer, that are used for the randomization. So if you, for instance, first randomizes with 50%, and then with 20%, the result will be maximum 20% away from the initial parameter settings, when the Randomizer page was entered. It does not first randomize 50%, and then randomize 20% on top of that. To randomize things further away, you must exit the Randomizer page, and re-enter it.

Synth Part Trigger Setup

In this block, you can set up the poly mode of each part, the pitch bend range, the note that will play back, when pushing a trigger button, and if the part should be an internal or an external part.

From the synth parts main page, touch TRIG to enter this page.

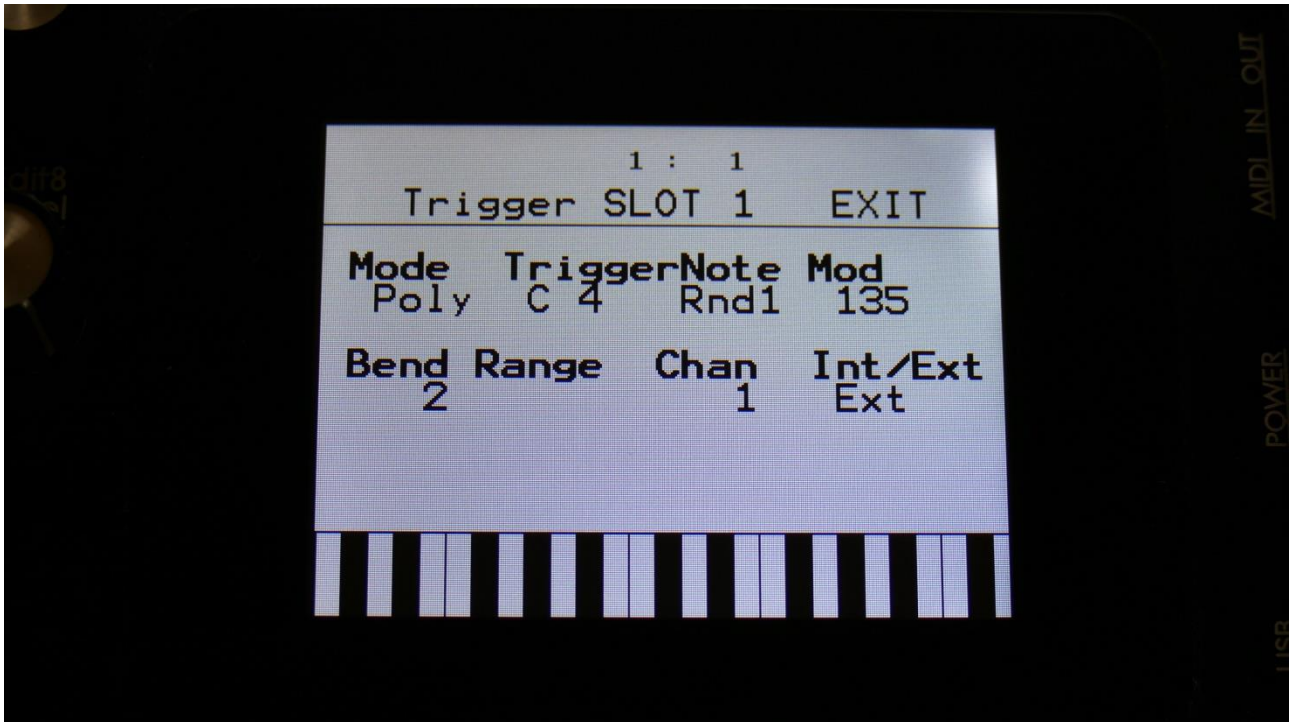

Mode: Part polyphonic/monophonic mode. Choices are:

Poly: The part uses multiple voices, to play back polyphonically.

Voic1-8: Mono To Voice1-8. The part plays back monophonically, and only uses the one voice, that it is assigned to. Other parts that are in poly mode, does not use this voice. It can only be cutted off, by another part that is set to mono to the same voice.

Use this mode, when playing back long samples and audio tracks without chops, and if you got some parts, that should cut each other off, like parts that are playing back closed and open hihats.

Vc1Lg-Vc8Lg: Mono To Voice1-8 with Legato Portamento. The same as Voic1-8 mode, but with legato portamento. If the portamento parameter on the Oscillator page is turned up, the portamento effect will only be active, when notes are played overlapped.

TriggerNote: C-1 to G9. The note that will play, when the step buttons are in trigger mode (when both the Func/Mute button and the Steps/Part button are unlit), and you push the trigger button, for this part. This is also the note that is sent via MIDI out, when a part is set to external, and you hit the trigger button.

And finally this is also the note, that is sent to the internal synth or to MIDI out, when a part is triggered by a CV input.

So it is possible to set one CV input up to trigger the part, and use another CV input to modulate the trigger note, for CV/Gate to MIDI conversion.

Trigger Note Modulation Source:

Any modulation source can modulate the trigger note. Only the positive modulation sources, can be selected by the Edit Knob. To make a modulation source negative, touch the modulation source parameter. For a complete list of modulation sources, see the list in the start of this section.

Mod: 0 to 512. Trigger Note Modulation amount

Bend Range: 0 to 12 notes. The global pitch bend range for all parts.

Chan: 1 to 16. The part output MIDI channel. This will also affect the part Sequencer Note Track. When the part is set to external, this is the MIDI channel that note data played by the trigger button, the touchscreen keyboard, on an attached MIDI device, and from the part sequencer note track are sent on, to the LD3 MIDI out.

Int/Ext: Sets the part in internal (Int) or external (Ext) mode.

When a part is set to **internal** mode, all notes played by the part trigger button, the touchscreen keyboard, on an attached MIDI device, and from the part sequencer note track, controls the internal LD3 synth part.

When a part is set to **external** mode, all notes played by the part trigger button, the touchscreen keyboard, on an attached MIDI device, and from the part sequencer note track, controls any MIDI device, that is connected to the LD3 MIDI output, and that is set to the same MIDI channel, as set by the Chan parameter on this page.

Zone Setup

In this block, it is possible to set up a key zone and a MIDI channel for the part, that will take effect, when LD3 is set in multi-timbral mode, and is controlled from an external MIDI device. How to set LD3 in multi-timbral mode are explained later in this manual, in the MOR>Common section.

From the synth parts main page, touch ZONE to enter this page.



LowK1: C-1 to G9. The lowest key of the part zone.

HiK1: C-1 to G9. The highest key of the part zone.

Trps1: -64 to +63. The incoming MIDI notes, inside the key zone, are transposed up(+) or down(-), by the selected value.

Chan1: 1 to 16. The MIDI channel that will control this part.

Audio BUS Setup

In this block, you will find the settings for the 8 audio busses. Please note that these settings are not part specific, but global for the 8 busses and 16 parts.

From the synth parts main page, touch TRIG to enter this page.

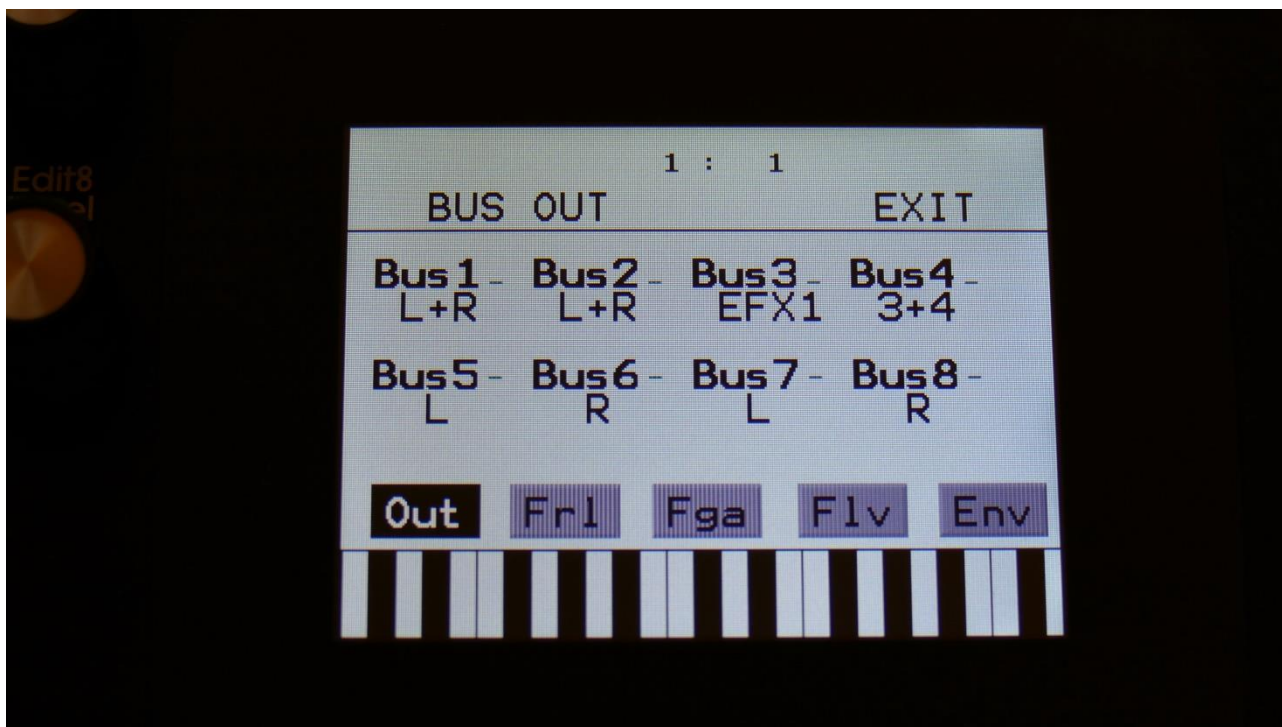

Touch the Out touch button, to enter this first page, where you can select the output, which the audio signal from each of the 8 busses, should be sent to.

Possibilities are:

L: The output of the Bus is sent to the left audio output.

R: The output of the Bus is sent to the right audio output.

L+R: The output of the Bus is sent to the left and the right audio outputs.

EFX1: The output of the Bus is sent to Output effect 1.

EFX2: The output of the Bus is sent to Output effect 2.

3: The output of the Bus is sent to the optional audio output 3.

4: The output of the Bus is sent to the optional audio output 4.

5: The output of the Bus is sent to the optional audio output 5.

6: The output of the Bus is sent to the optional audio output 6.

3+4: The output of the Bus is sent to the optional audio outputs 3 and 4.

5+6: The output of the Bus is sent to the optional audio outputs 5 and 6.

Off: The output of the Bus is not sent anywhere.

PLEASE NOTE: Audio busses that are assigned to be placed inside an output effect feedback loop, will ignore this setting, and only output to the effect feedback input.

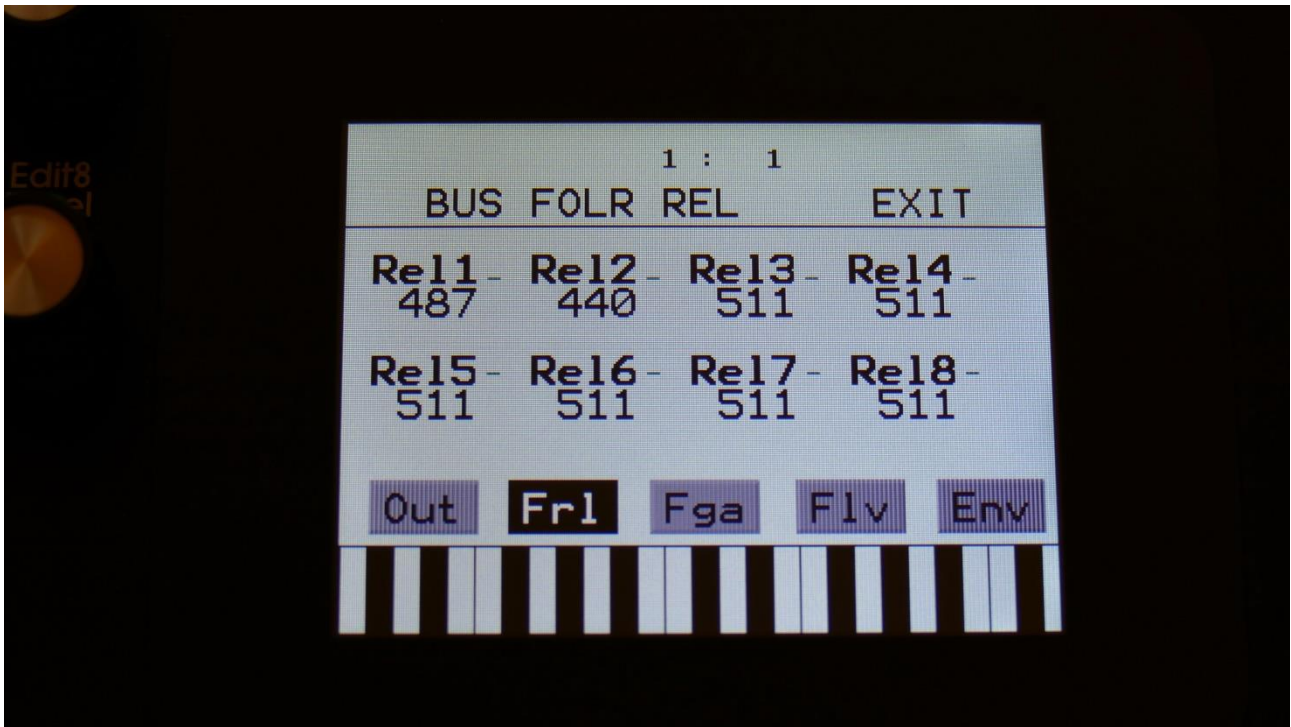

Touch the Frl touch button, to enter this second audio Bus page, where it is possible to adjust the release time of the envelope follower, that are attached to each audio Bus, and that affects the output levels of these. Each of the 8 audio busses has their own Envelope Follower.

When this is set to 511, the follower will never decay. When set to lower values, the follower will gradually decay, in accordance with the levels of the audio signal sent to it, from the synth parts.

The envelope followers are sent to the modulation system (Flw1 to Flw8), and can be selected as modulation sources, for many parameters.

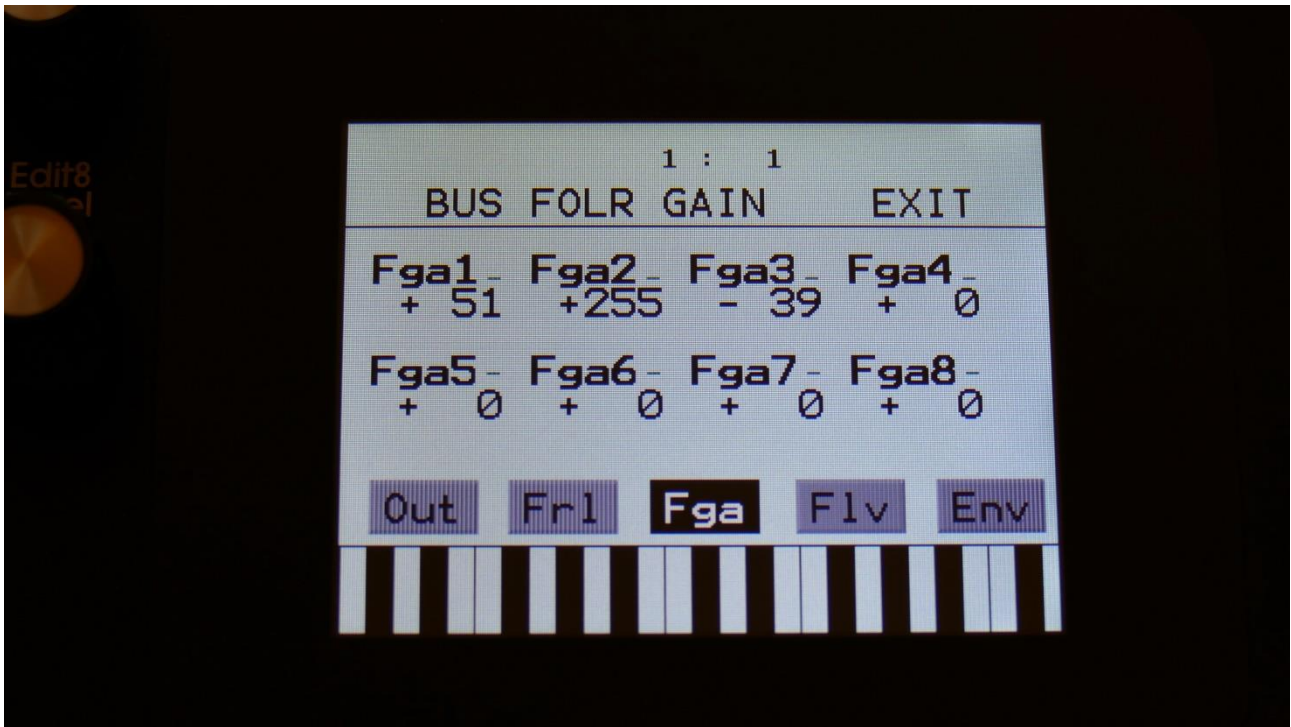

Touch the Fga touch button, to enter this third audio Bus page, where it is possible to gain or attenuate the level of the audio signal sent to the Bus envelope follower. At +0, there are no gaining or attenuation. At positive values the signal to the follower is gained, at negative values, they are attenuated.

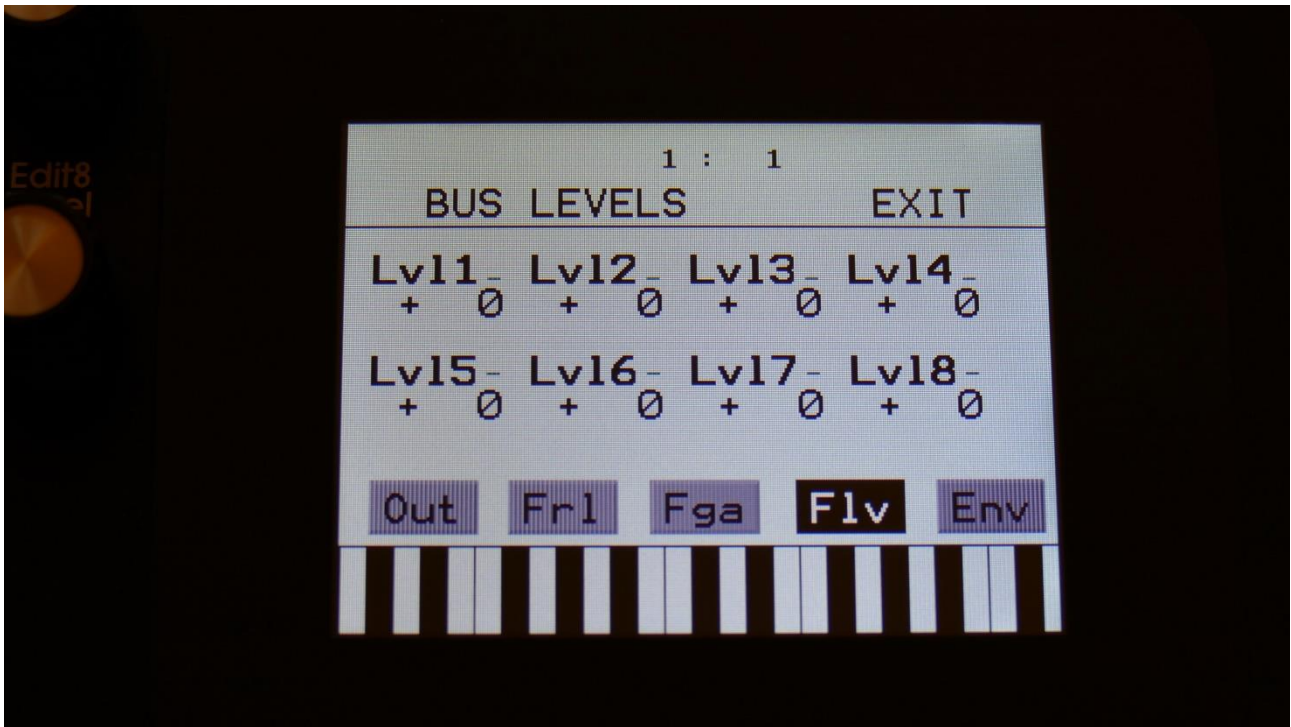

Touch the Flv touch button, to enter this fourth audio Bus page, where it is possible to adjust the total output level of each Bus. Positive values will gain the output signal, negative values will attenuate.

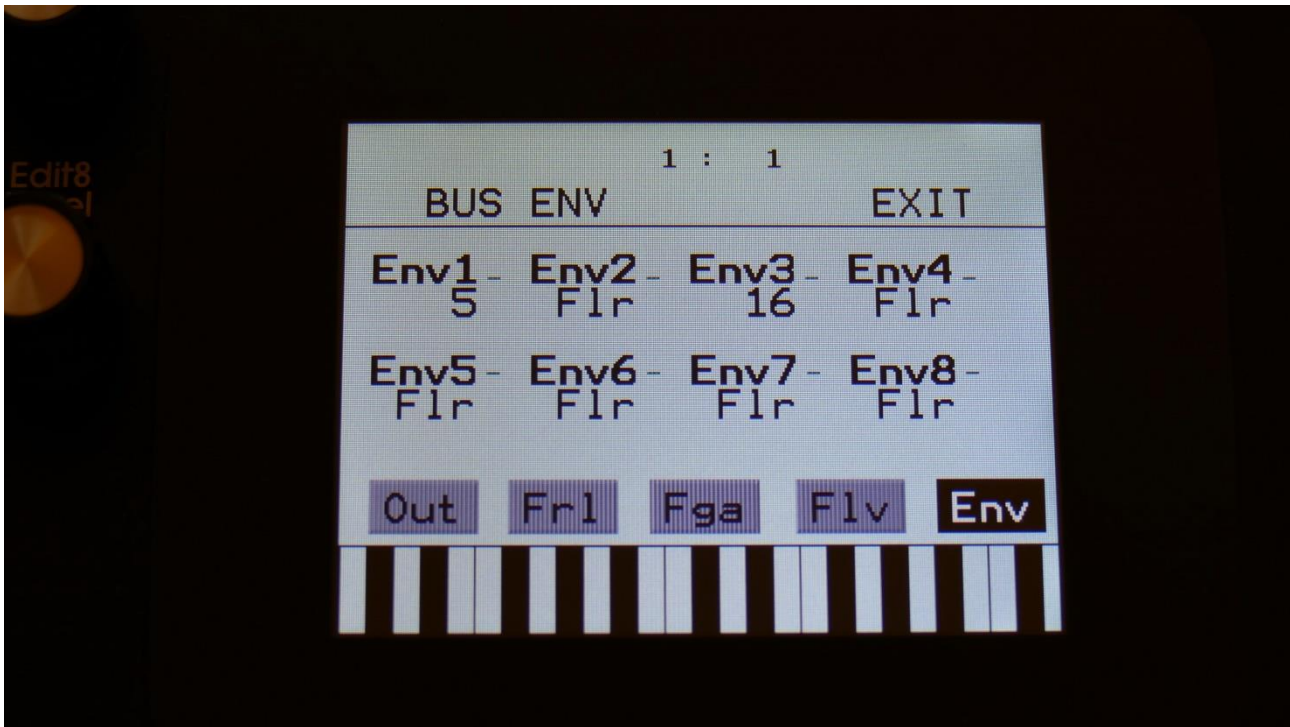

Touch the Env touch button, to enter this fifth and last audio Bus page, where it is possible to assign any of the 16 part VCA envelopes or the BUS Envelope Follower to control the Bus output level. Here it is also possible to gain the Envelope Follower by x2 and x4.

As default, the un-gained Envelope Follower are assigned to control the BUS output level.

Each audio bus has their own Envelope Follower (8 Envelope Followers in total).

The possible settings are:

Flr: The BUS Envelope Follower will control the output level of the BUS.

1 to 16: The Part Envelope of the part that has the number you select here, will control the output level of the BUS.

Fx2: The BUS Envelope Follower will control the output level of the BUS, and the signal of this will be gained by x2.

Fx4: The BUS Envelope Follower will control the output level of the BUS, and the signal of this will be gained by x4.

Oscillator/Sampler/Noise Generator

In this block, you will find the settings for the part oscillator.

From the synth parts main page, touch OSC to enter this page.

OR: Push and release the Func/Mute button, so that it lights up, and push step button 6/Osc 1 time.

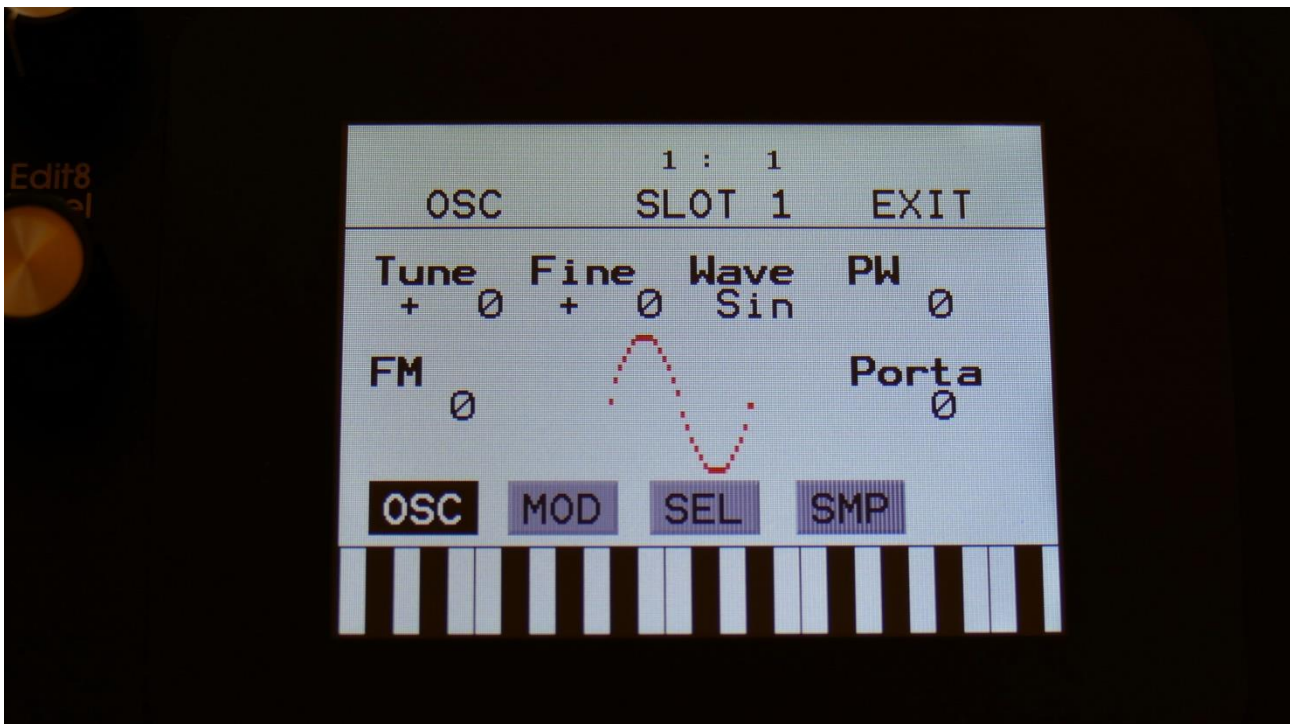

The oscillator are the first block in the audio chain of a part. This is responsible for generating the basic sound of each part, that can be modulated, filtered and effected, for shaping a sound.

An LD3 oscillator can be set to act as an oscillator, a sample player, a chopped keyboard sample player, or a noise generator.

In oscillator mode it generates a waveform that is morphable between sine, triangle, saw, pulse and feedback waves. Pulse width are adjustable for all waveform types. FM (frequency modulation) is possible, with any audio bus as the modulation source. Pitch, PW, wave and FM amount can be modulated. The pitch range of the oscillators are chromatically over the entire 10 octave MIDI keyboard range.

In sampler mode it plays back any of the 8.192 storable samplings, that can either be recorded on LD3 itself in the Sample Rec section, or be imported in the USB section. Each part sampler has 4

sample slots, that each can contain one sampling. Switching between the 4 samplings is done via the Chop parameter. Pitch, chop, start point and FM amount can be adjusted and modulated, Length can be adjusted. Samples are chromatically tuned, and has a pitch range of 4 octaves above and 5 octaves below the original sample pitch. Loop mode can be set to Off, On, toggle, sustain, off(unchopped) and on(unchopped).

In off and on modes, it will always use the sample chop point, if any.

In toggle mode, the looped sample playback will start, when you push and release a trigger button, and stop when you push and release the same trigger button again.

In sustain mode, it will play the sampling back from the start point, until it reaches the second chop point. Then it will loop back to the first chop point, and keep looping between these 2 points. When importing a wav sampling with loop points set as cue points, these cue points are imported to the first 2 chop points.

In off and on (unchopped) modes, the whole sampling will play back, ignoring any chop points.

It is possible to create chop points in the LD3 sample editor, and use these. Chops can be detected by level peaks, by single wavecycles, and by dividing the sample length with a settable number. Chop points will also be imported from wav files, containing these as cue points.

In sampler Xfade mode, it is possible to smoothly crossfade between 2 samplings. You can select sample A by the **Chop** parameter on the OSC page, and sample B by the **Chop2** parameter on the SEL page. The numbers selected by these parameters refer to the 4 samples, that is selected on the SMP page. A value of 1-64 will select a chop point in sample 1, a value of 65-128 will select a chop point in sample 2, a value of 129-192 will select a chop point in sample 3, and a value of 193-256 will select a chop point in sample 4. If no chop points exists in the selected sampling, the sampling itself will be selected.

When you have 2 samples selected, you can use the **Xfade** parameter on the SEL page to crossfade between these. The **Xfade** parameter can be modulated by any modulation source and morphed.

In chopped keyboard sample mode, the chops of the selected sampling, will be spread over the MIDI keyboard range.

The first chop will be placed at C2. Each chop will take up one key, and will not be tuned by the keyboard. Tuning is only possible, using the Tune, Fine and pitch modulation parameters.

On the next key, after the last chop, the first chop will be placed, and the rest of the chops will be repeated over the rest of the keyboard range.

If you set the #Smp parameter to 2 or 4, the Chop parameter on the OSC page, will select sample 1, 2, 3 and 4, to be laid out on the keyboard. Chop modulation will also switch between the 4 samplings.

If you select a sampling, that has no chops, the root key of this sampling, will be laid out over the entire keyboard range.

In noise generator mode, the oscillator puts out a noise waveform. Pitch and pw (intensity) can be set and modulated.

Oscillator parameters

The OSC page, when in oscillator mode:

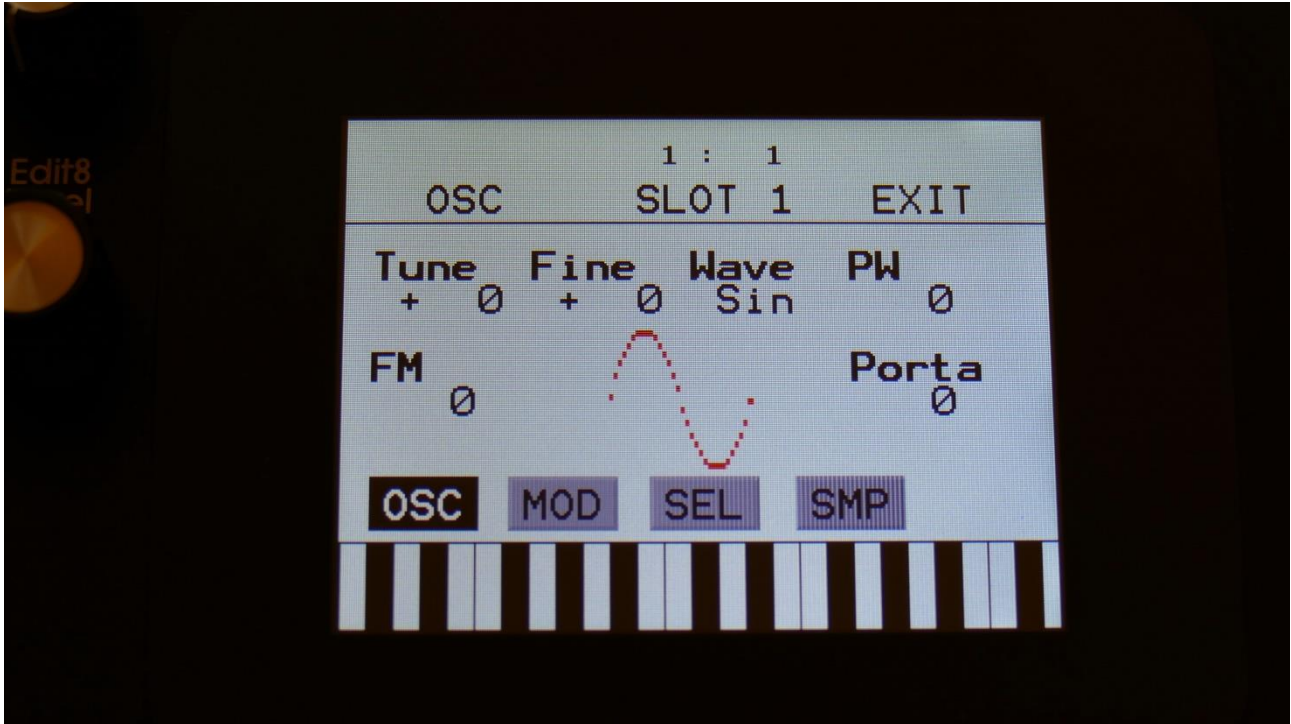

In the middle of the oscillator page, the currently generated waveform is shown.

Touch the buttons named OSC, MOD, SEL and SMP, to enter other oscillator pages, like Modulation and oscillator/sampler/noise mode select.

OR: Push and release the Func/Mute button, so that it lights up, and push step button 6/Osc to toggle between these pages.

Tune: Adjust the basic pitch in semitones. Range: -64 to + 63.

Fine: Fine tuning of the pitch. Range: -256 to +255.

Wave: This parameter lets you morph between sine, triange, saw, pulse and feedback waves.

PW: Adjusts the pulse width of the waveform. Unlike many other oscillator designs, the pulse width can be adjusted on all of LD3's waveforms, not just the pulse wave.

FM: FM amount. The more this is turned up, the more a selected audio bus (in the SEL section) will modulate the pitch of the oscillator. Range: 0 to 511.

Porta: Portamento. The more this is turned up, the slower the oscillator pitch will slide from one note to another. Range: 0 to 511.

The OSC page, when in Sampler, Chopped Keyboard mode and Xfade mode:

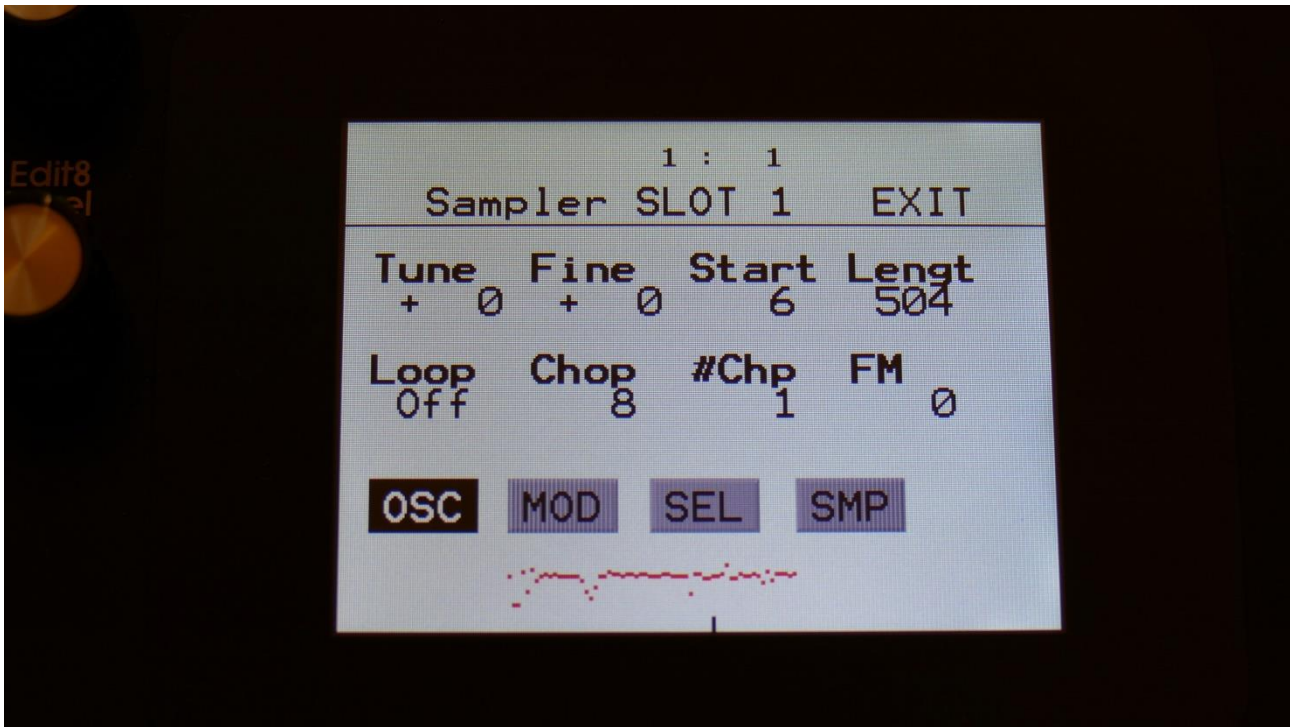

In the bottom of the sampler page, the selected samplings waveform is shown in rough graphics. When the sample, or part of it, is played back, the small black line below the waveform will show the current playback point.

Tune: Adjust the basic pitch in semitones. Range: -64 to + 63.

Fine: Fine tuning of the pitch. Range: -256 to +255.

Start: The sample start point. Selects at what point the sample will start to play back, when it is triggered. Range: 0 to 511, stretching over the whole sampling.

Length: Sets how much of the sampling should be played back. Range: 0 to 511, stretching over the whole sampling.

Loop: Sets the sampling loop mode.

Off: The sample will not loop, just play back one time from the adjusted, or chop selected, start to end, and then stop. If the selected sampling has chop points, these will always be used.

On: The sample will play back from the adjusted start point, when triggered. When it reaches the adjusted end point, it will loop back to the start point, and play back the sample over and over again. If the selected sampling has chop points, these will always be used for the loop points.

Toggle: The looped sample playback will start, when you push and release a trigger button, and stop when you push and release the same trigger button again.

Sust: When you hit a key, playback of the sampling starts at the sample startpoint.

When the playback reaches the endpoint of the selected chop, it loops back to the chop startpoint, and keeps looping between the chop start and end point, until a key is pressed again.

OfUc: Off, unchopped. The sample will not loop, just play back one time from the adjusted start to end, and then stop. Chop points will be ignored.

OnUc: On, unchopped. The sample will play back from the adjusted start point, when triggered. When it reaches the adjusted end point, it will loop back to the start point, and play back the sample over and over again. Chop points will be ignored.

Chop: If chop points has been generated for the selected sampling, a chop can be selected by setting this parameter. If the #Smp parameter on the SEL page is set to 2 or 4 samplings, this parameter will also select which of the 2 or 4 samplings, that will play back, and the chop points for sample 2 to 4. Range: 0 to 63 for sample 1, 64 to 128 for sample 2, 129 to 192 for sample 3, 193 to 255 for sample 4.

In chopped keyboard sample mode, this parameter and the chop modulation selects one of the 4 selected samplings, which will have its chops spread over the keyboard range.

0-63: Sample 1, 64-127: Sample 2, 128-191: Sample 3, 192-255: Sample 4.

This parameter can be morphed and modulated in most modes, but not in Xfade mode. In Xfade mode, the #Smp parameter are ignored, and set at the fixed value of 4 samplings.

#Chp: The number of Chops to be played back in a row. Range: 1 to 64.

FM: FM amount. The more this is turned up, the more the selected FM bus (in the SEL section) will modulate the pitch of the sampler. Range: 0 to 511.

Oscillator modulation

The MOD page, when in oscillator mode:



The small VU-meters next to the parameters, shows the activity of the selected modulation sources.

For each parameter, that can be modulated, it is possible to select a modulation source, and to adjust the modulation amount. Only the positive modulation sources, can be selected by the Edit Knobs. To make a modulation source negative, touch the modulation source parameter. For a complete list of modulation sources, see the list in the start of this section.

The upper row of parameters selects the modulation sources, **The lower row of parameters** (Labelled Amt) adjusts the modulation amount in the range 0 to 511.

The parameters on this page:

Pitc: Modulates the oscillator pitch.

Wave: Modulates the wave select morphing.

PWM: Modulates the pulse width of the waveform

FM: Modulates the FM amount.

The MOD page, when in sampler or chopped keyboard mode:



The small VU-meters next to the parameters, shows the activity of the selected modulation sources.

For each parameter, that can be modulated, it is possible to select a modulation source, and to adjust the modulation amount. Only the positive modulation sources, can be selected by the Edit Knobs. To make a modulation source negative, touch the modulation source parameter. For a complete list of modulation sources, see the list in the start of this section.

The upper row of parameters selects the modulation sources, **The lower row of parameters** (Labelled Amt) adjusts the modulation amount in the range 0 to 511.

The parameters on this page:

Pitc: Modulates the sampler pitch.

Chop: Modulates the Chop number select, and sample select if #Smp is set to 2 or 4.

Start: Modulates the sample start point.

FM: Modulates the FM amount.

The MOD page, when in sampler Xfade mode:

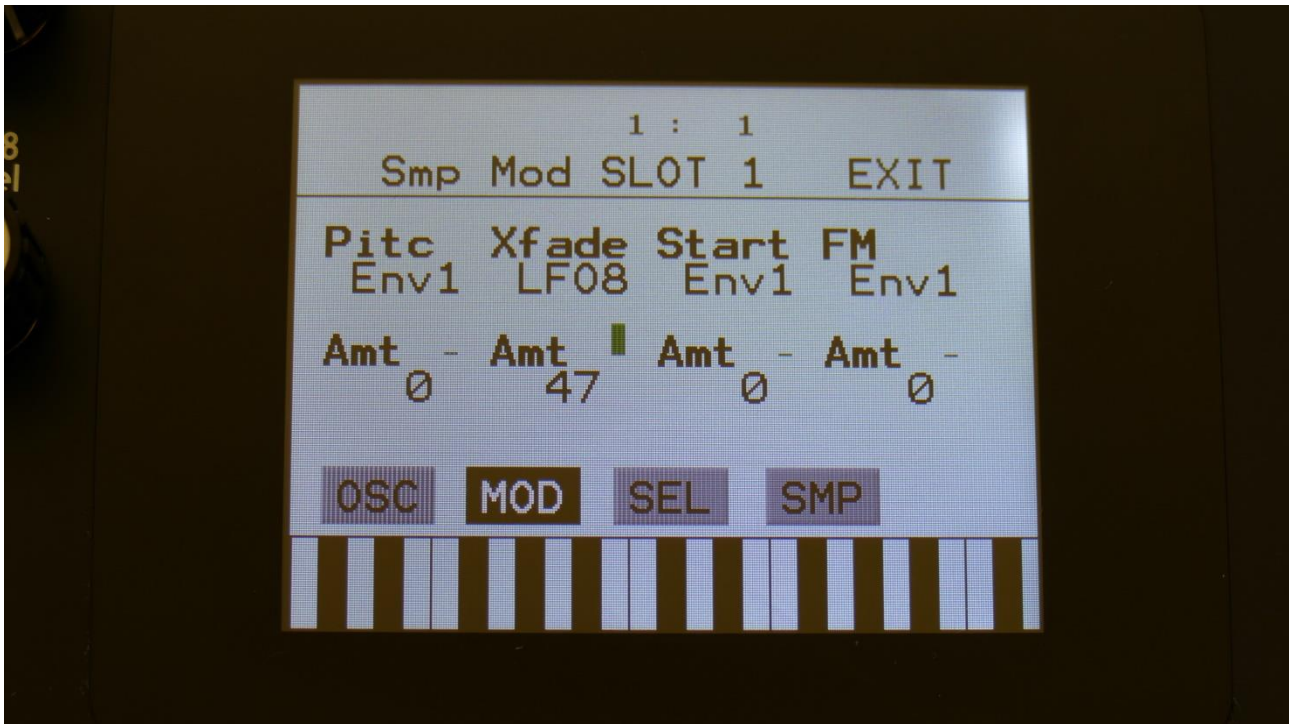

The small VU-meters next to the parameters, shows the activity of the selected modulation sources.

For each parameter, that can be modulated, it is possible to select a modulation source, and to adjust the modulation amount. Only the positive modulation sources, can be selected by the Edit Knobs. To make a modulation source negative, touch the modulation source parameter. For a complete list of modulation sources, see the list in the start of this section.

The upper row of parameters selects the modulation sources, **The lower row of parameters** (Labelled Amt) adjusts the modulation amount in the range 0 to 511.

The parameters on this page:

Pitc: Modulates the sampler pitch.

Xfade: Modulates the crossfade between the 2 selected samplings.

Start: Modulates the sample start point.

FM: Modulates the FM amount.

Oscillator/Sampler/Chopped Keyboard/Xfade/Noise mode select

Touch the SEL button, to enter this page. OR: Push and release the Func/Mute button, so that it lights up, and push step button 6/Osc 3 times.

The mode select page, when in oscillator, sampler or chopped keyboard mode:



Xfade: Sample fade mode. Only affects sample playback.

Off: No fading are applied to sample playback.

On: When playing back a sampling, both fade in and fade out will be applied.

Especially effective, to obtain click free audio track playback.

Out: When playing back a sampling, fade out will be applied, to remove clicks at the sample end.

Smth: Smoothing. The moment that a sampling loops, the transition from the loop end to the loop start will be smoothed out, to minimize clicks.

FmBus: Sets the FM source audio bus for the oscillator/sampler frequency modulation. FM amount is set on the OSC page. Audio bus 1 to 8 can be selected.

Porta: Sampler Portamento. The more this is turned up, the slower the sampler pitch will slide from one note to another. Range: 0 to 511.

Mode: Selects whether the part oscillator should act as an oscillator (Osc), a sampler (Smp), a chopped keyboard sampler (ChKy), noise generator (Nois), or sampler Xfade mode (Xfad).

#Smp: Number of samplings. Sets if the part should use 1, 2 or 4 samplings. The 4 samplings are selected on the SMP page, and the samplings can be selected, using the Chop parameter on the sampler OSC page.

TrgTo: Off, 1 to 16. Makes this part trigger another part. If set to this part, the part will double trigger. The TrLen parameter must be higher than 0, to trigger.

TrDly: 0 to 511. Trigger delay. Will add a delay, before it triggers the other part, if set to any other values than zero.

TrLen: 0 to 511. Trigger length. Sets how long the extra trigger gate should be. If set to zero, it might not trigger.

The mode select page, when in sampler Xfade mode:

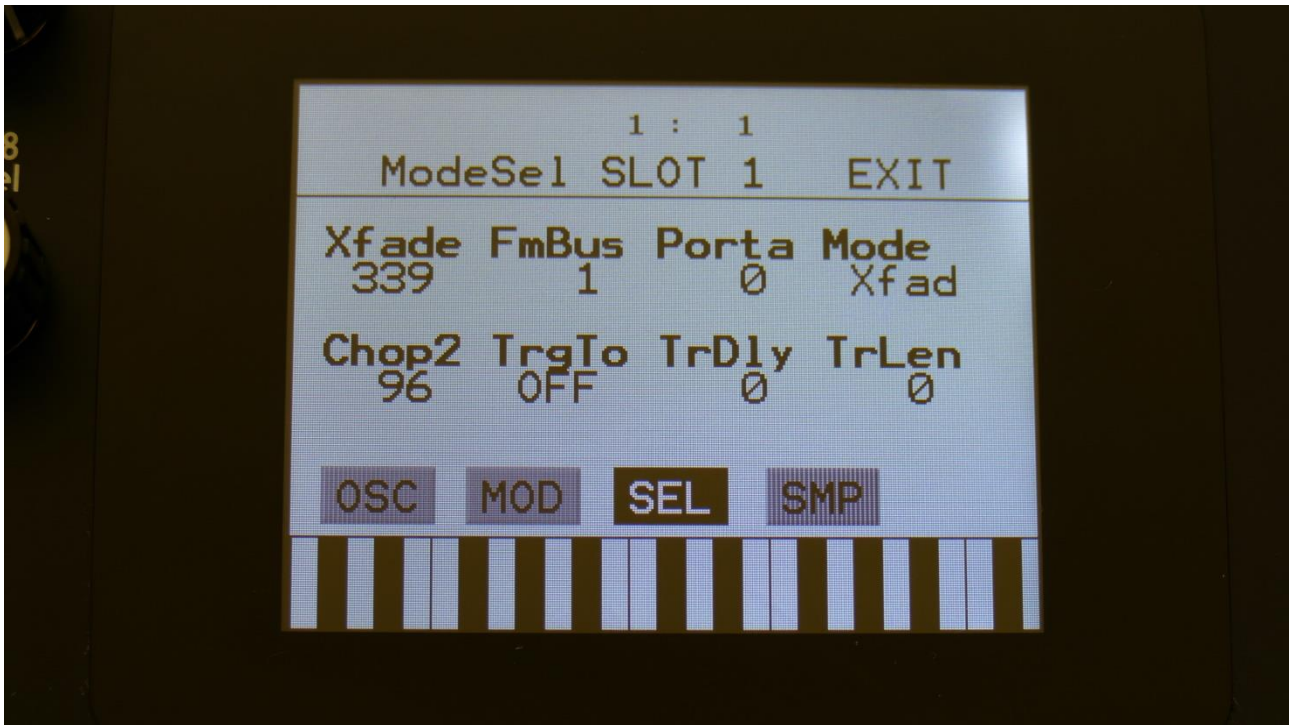

Xfade: Sample crossfade position. By turning this parameter from the lowest to the highest position, LD3 will crossfade from the sampling selected by the Chop parameter, to the sampling selected by the Chop2 parameter. This parameter can be morphed and modulated. Range: 0 to 511.

FmBus: Sets the FM source audio bus for the oscillator/sampler frequency modulation. FM amount is set on the OSC page. Audio bus 1 to 8 can be selected.

Porta: Sampler Portamento. The more this is turned up, the slower the sampler pitch will slide from one note to another. Range: 0 to 511.

Mode: Selects whether the part oscillator should act as an oscillator (Osc), a sampler (Smp), a chopped keyboard sampler (ChKy), noise generator (Nois), or sampler Xfade mode (Xfad).

Chop2: Selects the sample/chop point, the will be crossfaded to, when turning the Xfade parameter. If chop points has been generated for the selected sampling, a chop can be selected by setting this parameter. Range: 0 to 63 for sample 1, 64 to 128 for sample 2, 129 to 192 for sample 3, 193 to 255 for sample 4.

TrgTo: Off, 1 to 16. Makes this part trigger another part. If set to this part, the part will double trigger. The TrLen parameter must be higher than 0, to trigger.

TrDly: 0 to 511. Trigger delay. Will add a delay, before it triggers the other part, if set to any other values than zero.

TrLen: 0 to 511. Trigger length. Sets how long the extra trigger gate should be. If set to zero, it might not trigger.

Some limitations in Xfade mode:

-The Chop and Chop2 parameters can't be morphed in this mode. The Xfade parameter can though be morphed.

-In this mode, digital filter 2 are not available. Filter 1 will though act as a stereo filter.

Part Samples Select

Touch the SMP button, to enter this page. OR: Push and release the Func/Mute button, so that it lights up, and push step button 6/Osc 4 times.

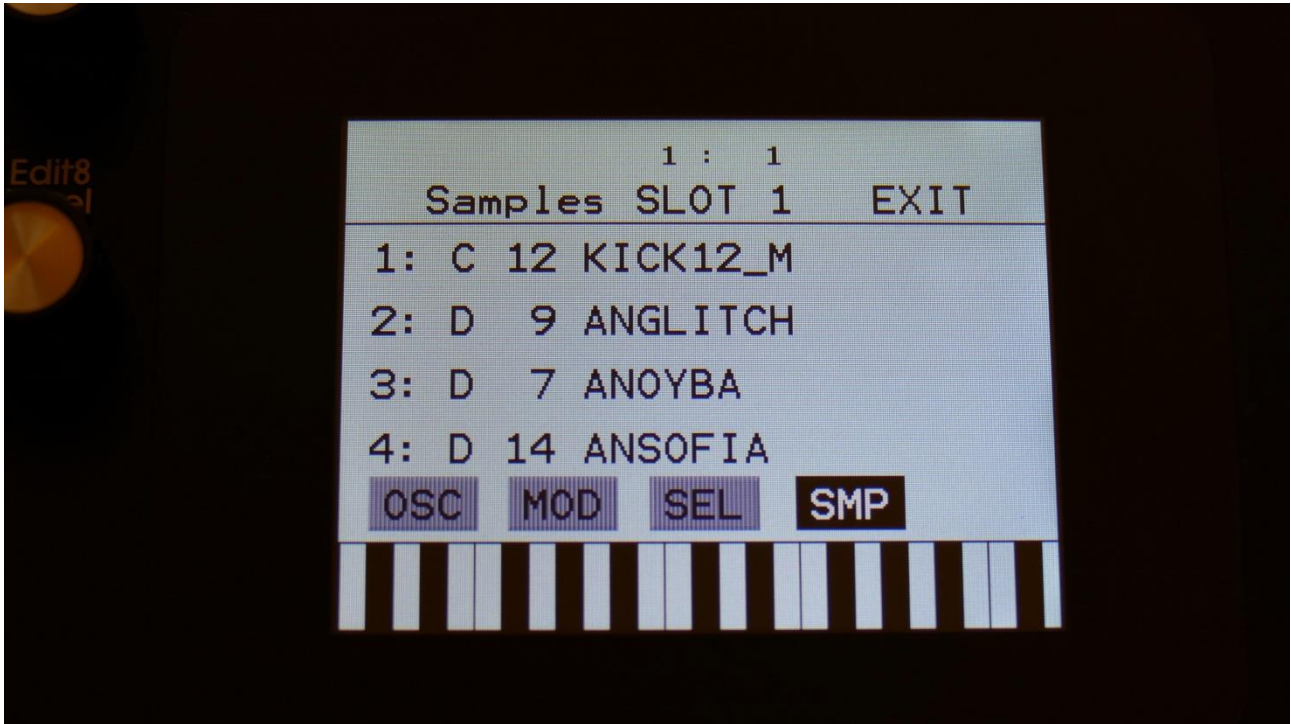

Here you can select 4 samplings for the part. The number of these samplings, that are used, is set by the #Smp parameter on the SEL page. The 4 samples can be selected to play back, setting the Chop parameter, and by chop select modulation.

To select a sampling for any of the 4 slots, simply touch the sample name. Now this page will pop up:

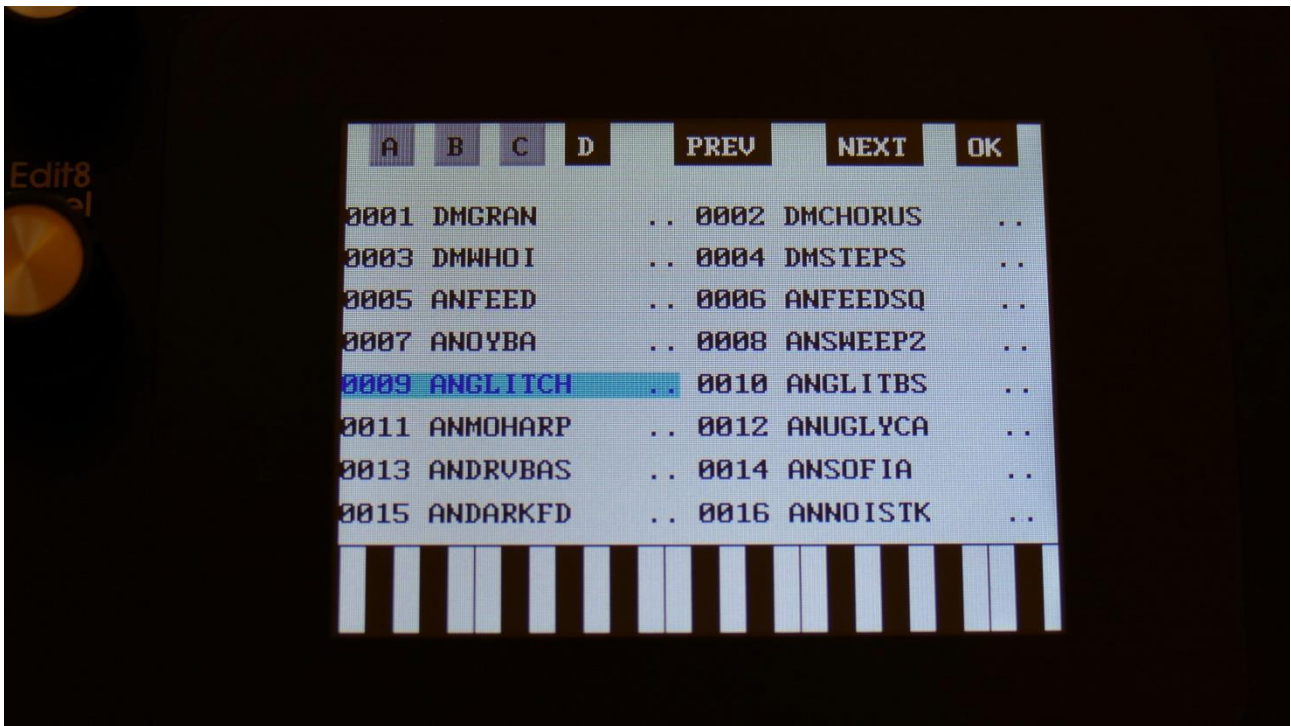

On each page you will view 16 of the samplings, that are held in the LD3 FLASH memory, Bank A, B, C or D.

Touch A, B, C and D to select the sample bank, touch PREV and NEXT to view the previous or next 16 samplings.

To select a sampling, touch the sample name.

A small red square is shown near the sample name of the sampling, that are the last one, that was added to the bank.

When you have found the right sampling, touch OK to return to the Synth Part Sample Select page.

The Granular Modulators

Each of the 16 synth parts of LD3 has 2 granular modulators, the granular random generator and the granular sequence modulator, that shows as modulation sources, to any parameter that can be modulated.

GrRn – Granular Random Generator

This works in conjunction with the part oscillator, sampler or noise generator.

When in oscillator or noise mode:

Every time the synth waveform starts over, the granular random generator puts out a new random value. When modulating the oscillator wave parameter with this, it will randomly glue different waveforms together, for granular chaos. Since any parameter can be modulated by this, the possibilities are endless.

When in sampler mode:

Every time the sampler loops, the granular random generator will put out a new random value. If you have a wave chopped sampling, and set this parameter up to modulate the chop select parameter, granular random sample chaos will be obtained. Of course, this can also modulate any other parameter, for infinite possibilities.

GrSq – Granular Sequence Modulator

This works in conjunction with the part oscillator, sampler or noise generator, and a Sequencer Controller track. It does not use the output of the controller track directly, only the step values and the last step parameter.

The oscillator of part 1 uses controller track 17 for sequence values, part 2 uses controller track 18, part 3 uses controller track 19 and so on...

When in oscillator or noise mode:

Every time the synth waveform starts over, the granular sequence modulator gets the next value from the associated controller track. When modulating the oscillator wave parameter with this, it is possible to program wave sequences. Since any parameter can be modulated by this, the possibilities are endless.

When in sampler mode:

Every time the sampler loops, the granular sequence modulator gets the next value from the associated controller track. If you have a wave chopped sampling, and set this parameter up to modulate the chop select parameter, it is possible to program wave sequences. Of course, this can also modulate any other parameter, for infinite possibilities.

4 Random Generators

Each synth part of LD3 has 4 random generators, that takes in a new random value, every time the part is triggered.

There are no settings to be made for these. They are found as modulation sources, named: Rnd1, Rnd2, Rnd3 and Rnd4.

The Digital Filters

Each LD3 part has 2 digital filters. For each of these, 16 different filter types can be selected. They have various lowpass, highpass and bandpass modes, with different characteristics, but also special modes like Lo-Fi, destruktion and Fat. They can be connected in serial or parallel to each other, work as one stereo filter, and their parameters can be linked to each other, for easier tweaking in stereo mode.

If the Oscillator of the part is set in Sample Xfade mode, digital filter 2 is not available, and digital filter 1 will act as a stereo filter.

When different filter types are selected for Morph Layer A and B, LD3 will morph between the filter types.

For extra filtering, the same filters are available as insert effects. The filters in the effect processors does though not morph between different filter types.

List of Digital Filter Types:

LPF1: Lowpass filter with a rather weak character. Resonance does not self-oscillate.

LPF2: Lowpass filter that are a bit sharper than LPF1. Resonance does not self-oscillate.

LPF3: Sharp Lowpass filter with self-oscillating resonance.

LPF4: Very sharp Lowpass filter with self-oscillating resonance.

BPF1: Bandpass filter with a rather weak character. Resonance does not self-oscillate.

BPF2: Bandpass filter with focus on the bass area. Distorts at higher input levels. Resonance does not self-oscillate.

BPF3: Sharp Bandpass filter with self-oscillating resonance.

HPF1: Sharp Highpass filter with self-oscillating resonance.

HPF2: High gained Highpass filter with self-oscillating resonance. Distorts at higher input levels.

HPF3: Sharp Highpass filter with self-oscillating resonance. A bit weaker than HPF1.

Dstr: Destruktion. A rather defective filter. Self-oscillates at some points, distorts at others.

FAT1: Slightly distorting lowpass filter, with a sharp response and self-oscillating resonance.

FAT2: A slightly weaker version of FAT1.

LoFi: A very distorting and unpredictable lowpass filter.

LPF5: A lowpass filter with a very soft character. Resonance does not self-oscillate.

BPF4: A bandpass filter with a very soft character and self-oscillating resonance.

Digital Filters Parameters

From the synth parts main page, touch FLT to enter the digital filters. OR: Push and release the Func/Mute button, so that it lights up, and push step button 7/Filter 1 time.

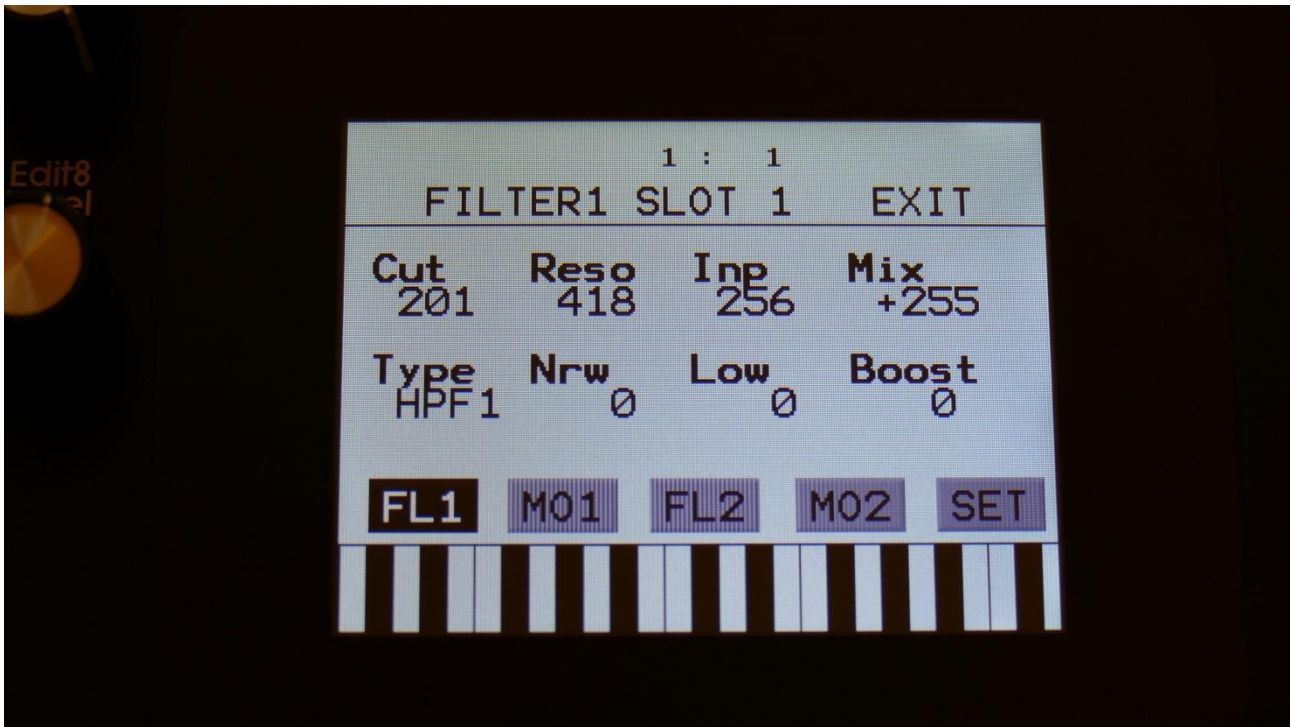

Touch the FL1 touch button, to enter the Filter 1 page.

Cut: 0 to 511. Sets the cutoff frequency of the filter.

Reso: 0 to 511. Sets the amount of resonance applied to the filter.

Inp: 0 to 511. Sets the audio signal input level to the filter. Different characteristics can be obtained by adjusting this.

Mix: -256 to +255. Sets the mix between the audio input signal and the filter output signal. At +0 the input signal is passed through. At positive values, the the filter output is added to the input signal. At negative values, an inverted version of the filter output is added to the input signal. At +255 and -256 only the output of the filter is heard.

Type: Sets the filter type. See the list of filter types.

Nrw: 0 to 511. Turning this up, will make the frequency response of the filter more and more narrow.

Low: 0 to 511. Sets the lowest frequency offset point of the filter. Turning this up, will in many filter types, make the bass bottom more present or distorted.

Boost: 0 to 511. Gains the filter output level.

Filter 1 Modulation

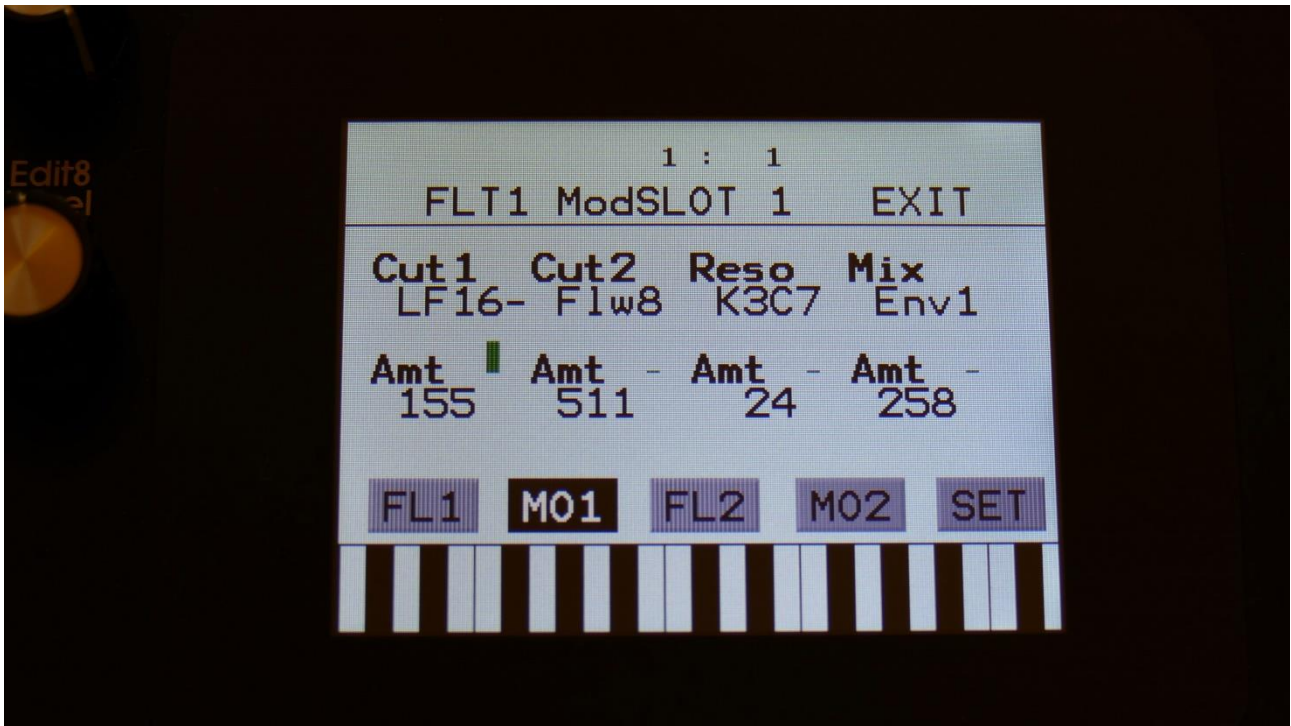

Touch the MO1 touch button, to enter the Filter 1 Modulation page.

The small VU-meters next to the parameters, shows the activity of the selected modulation sources.

For each parameter, that can be modulated, it is possible to select a modulation source, and to adjust the modulation amount. Only the positive modulation sources, can be selected by the Edit Knobs. To make a modulation source negative, touch the modulation source parameter. For a complete list of modulation sources, see the list in the start of this section.

Cut1, Cut2: Will modulate the filter cutoff frequency.

Reso: Will modulate the amount of resonance applied to the filter.

Mix: Will modulate the filter Mix.

Filter 2 (Not available when Osc is in Xfade mode)

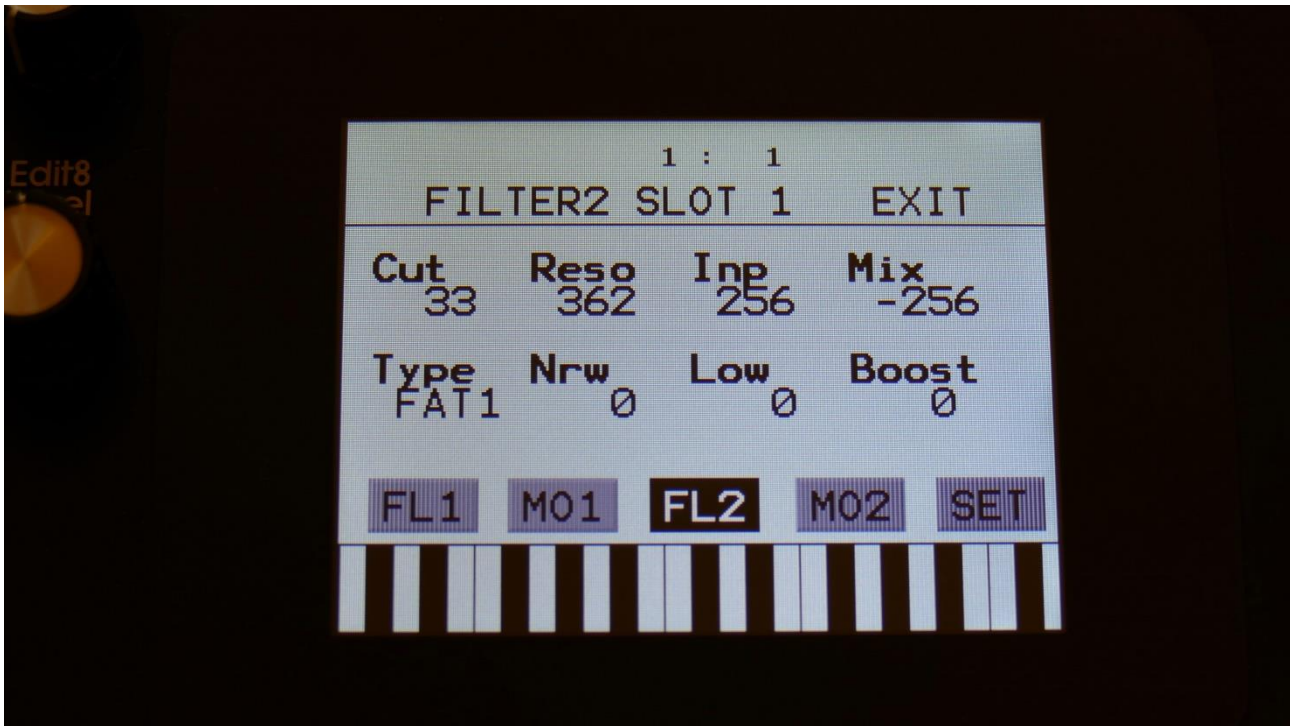

Touch the FL2 touch button, to enter the Filter 2 page.

Cut: 0 to 511. Sets the cutoff frequency of the filter.

Reso: 0 to 511. Sets the amount of resonance applied to the filter.

Inp: 0 to 511. Sets the audio signal input level to the filter. Different characteristics can be obtained by adjusting this.

Mix: -256 to +255. Sets the mix between the audio input signal and the filter output signal. At +0 the input signal is passed through. At positive values, the the filter output is added to the input signal. At negative values, an inverted version of the filter output is added to the input signal. At +255 and -256 only the output of the filter is heard.

Type: Sets the filter type. See the list of filter types.

Nrwl: 0 to 511. Turning this up, will make the frequency response of the filter more and more narrow.

Low: 0 to 511. Sets the lowest frequency offset point of the filter. Turning this up, will in many filter types, make the bass bottom more present or distorted.

Boost: 0 to 511. Gains the filter output level.

Filter 2 Modulation (Not available when Osc is in Xfade mode)

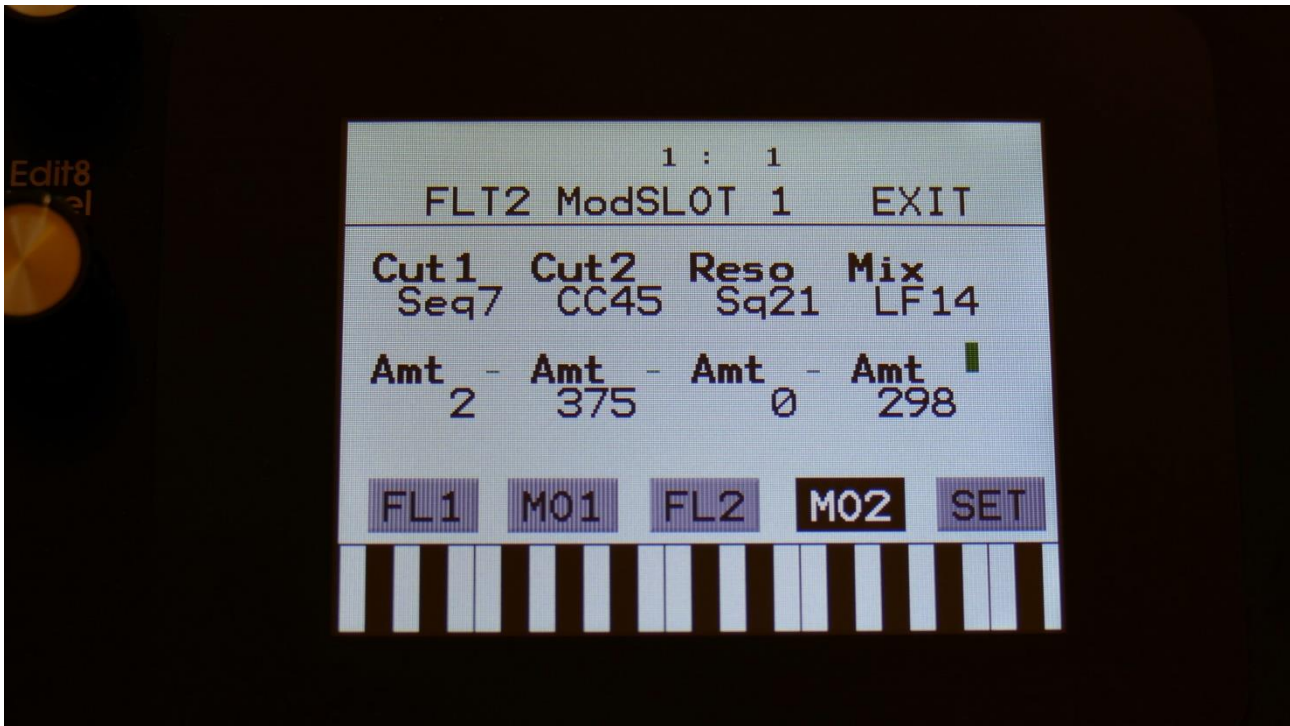

Touch the MO2 touch button, to enter the Filter 2 Modulation page.

The small VU-meters next to the parameters, shows the activity of the selected modulation sources.

For each parameter, that can be modulated, it is possible to select a modulation source, and to adjust the modulation amount. Only the positive modulation sources, can be selected by the Edit Knobs. To make a modulation source negative, touch the modulation source parameter. For a complete list of modulation sources, see the list in the start of this section.

Cut1, Cut2: Will modulate the filter cutoff frequency.

Reso: Will modulate the amount of resonance applied to the filter.

Mix: Will modulate the filter Mix.

Filters Setup (Not available when Osc is in Xfade mode –Filter1 is always stereo)



Touch the SET touch button, to enter the Filters Setup page.

Stereo: Off, On.

When off, the left and the right audio signals, coming from the oscillators (only really effective, when stereo samplings are played back), are mixed to one mono signal, that goes through both filters.

When on, filter 1 affects only the left channel of the audio signal, and filter 2 affects only the right.

Conn: Filters connection parallel (Par) or serial (Ser).

Link: Off, On. When on, any setting made on filter 1, is automatically performed on filter 2 too. Can be useful for stereo performance.

VCA

The VCA is the last stage of a synth part, before the audio is sent to the Audio Bus system. The audio output from the digital filter, goes into the VCA.

The VCA's can behave in 4 different modes. Linear, logarithmic, smooth linear and smooth logarithmic. The smooth VCA modes behaves like the VCA's found in most other synthesizers.

The audio output of the VCA can be level modulated and panned. Pan can also be modulated. The output of the VCA can be sent to 2 audio busses at the same time. When set up like this, the pan control/modulation, is panning the audio signal between the 2 audio busses. For a stereo panned output, one of these busses must be set to the right audio output, and the other to the left. It is also possible to send one bus to output effect 1, and the other to output effect 2. Then the pan control/modulation will mix between the 2 effects. Of course, filters and insert effects can also be placed on these busses, for more sonic possibilities.

An ADSR envelope are attached to the VCA. The VCA envelopes can either be in linear or logarithmic mode. A Drone parameter are available, for opening the VCA without the envelope needing to be triggered. VCA output level are modulated by the attached ADSR envelope. Attack and release can be modulated by any modulation source.

VCA Parameters

From the synth parts main page, touch VCA to enter the VCA pages. OR: Push and release the Func/Mute button, so that it lights up, and push step button 8/VCA 1 time.

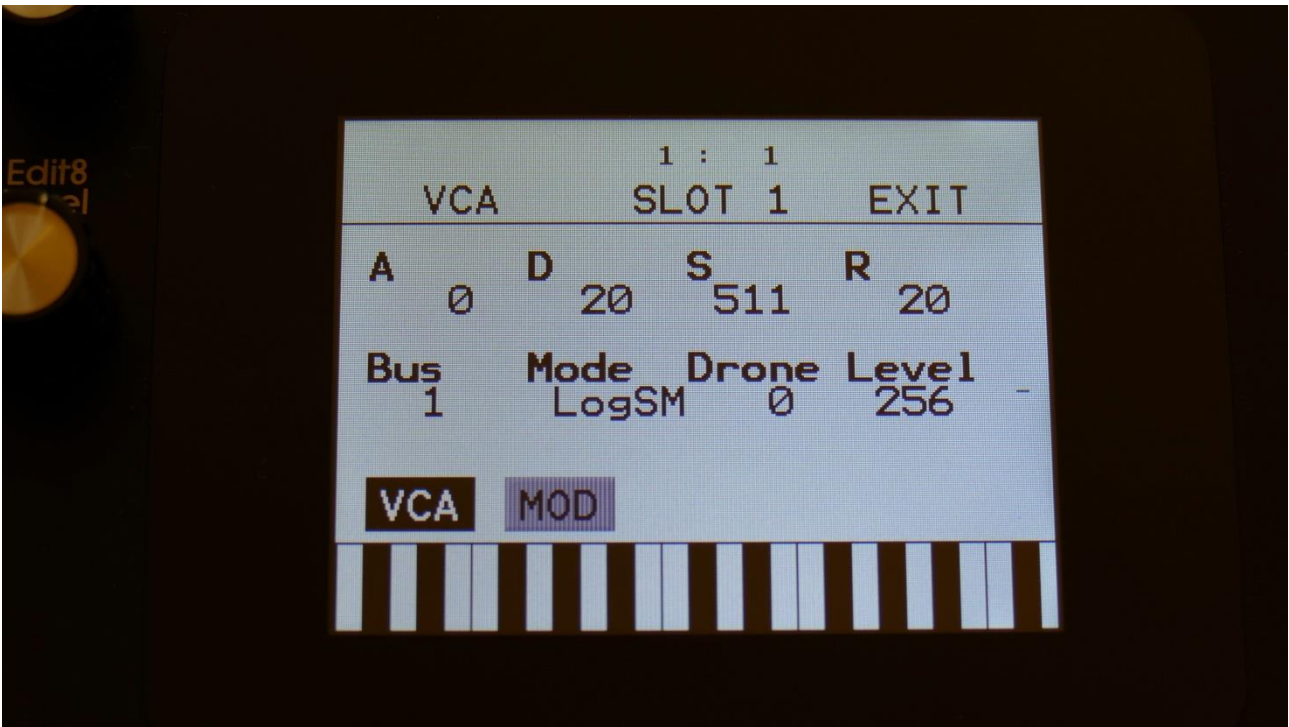

Touch the VCA touch button, to enter the VCA parameters page.

The VU-meter at the right of the screen, shows the VCA output activity.

A: 0 to 511. VCA envelope attack time. The time it will take the VCA envelope to rise from zero to its maximum value, when a note event is received and held down.

D: 0 to 511. VCA envelope decay time. When the VCA envelope has reached its maximum value, in the time set by the attack parameter, it will decay, until it reaches the sustain level, and stay there, as long as the note that triggered it is held.

S: 0 to 511. VCA envelope sustain level. Explained under the "D" parameter.

R: 0 to 511. VCA envelope release time. The time it will take the VCA envelope to decay from the value it is at, when a note off event are received, to zero.

Bus: 1/2 , 3/4 , 5/6 , 7/8 , 1, 2, 3, 4, 5, 6, 7, 8. Selects to which Audio Bus(es) the VCA should output its audio to. When 2 busses are selected, the pan parameter and modulation, pans the audio signal between the 2 busses.

Mode: Selects if the VCA behaviour should be linear (**Lin**), logarithmic (**Log**), smooth linear (**LinSM**) or smooth logarithmic (**LogSM**). The logarithmic curve gives the sound a softer and less “clicky” attack. The smooth modes produces no clicking at all.

Drone: 0 to 511. VCA envelope drone offset level. When this is turned up, the VCA envelope will never reach an output value, lower than what this is adjusted to –It will release to this adjusted value, instead of zero. Use this to keep the output of a synth part open for drone sounds.

Level: The VCA output level.

VCA Modulation

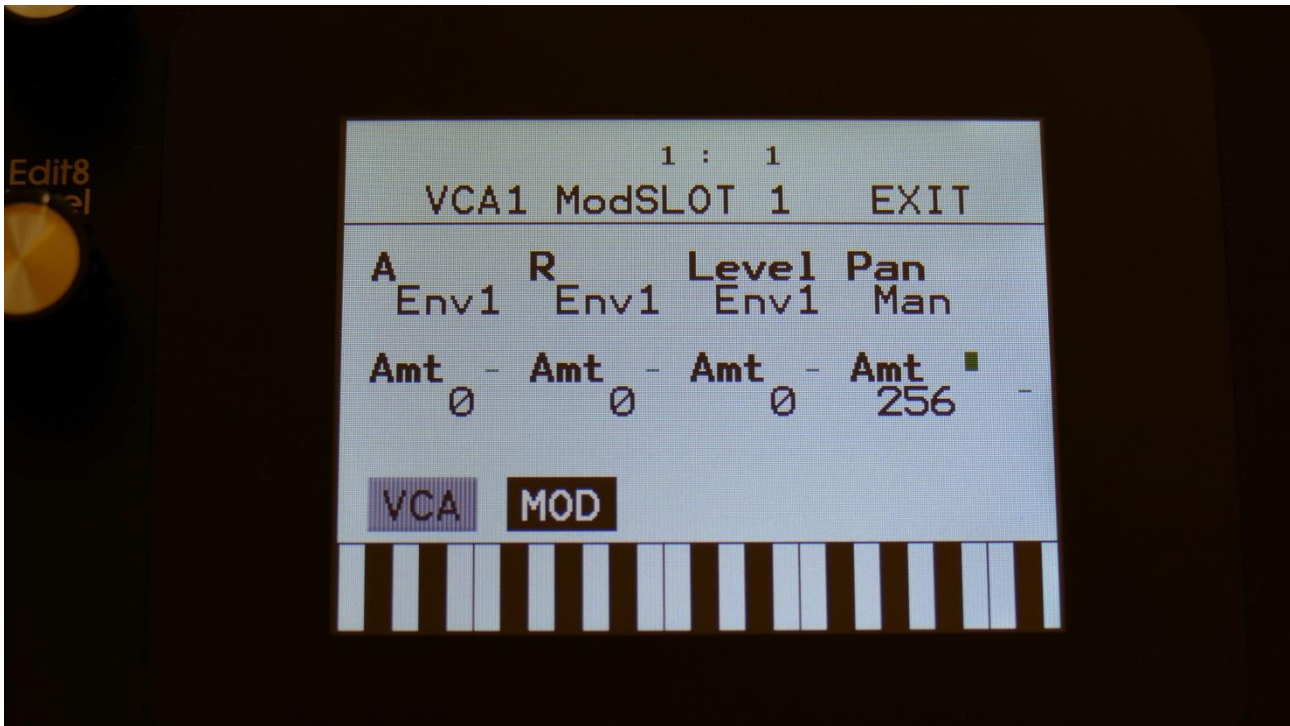

Touch the MOD touch button, to enter the VCA modulation page. OR: Push and release the Func/Mute button, so that it lights up, and push step button 8/VCA 2 times.

The VU-meter at the right of the screen, shows the VCA output activity. The small VU-meters next to the parameters, shows the activity of the selected modulation sources.

For each parameter, that can be modulated, it is possible to select a modulation source, and to adjust the modulation amount. Only the positive modulation sources, can be selected by the Edit Knobs. To make a modulation source negative, touch the modulation source parameter. For a complete list of modulation sources, see the list in the start of this section.

A: Modulates the VCA Envelope attack time.

R: Modulates the VCA Envelope release time.

Level: Modulates the output level of the VCA.

Pan: Modulates the output panning of the VCA. When source is set to manual (“Man”), the amount parameter manually adjusts the output panning.

Envelope 1 and 2

Each Synth part of LD3 has 2 modulation envelopes. One ADSR type, and one decay only envelope. Envelope 1, the ADSR envelope can have linear or logarithmic characteristics and it also has an offset control.

Envelope 2, the decay envelope, is always linear.

Envelope 1 and 2 Parameters

From the synth parts main page, touch ENV to enter the envelope pages. OR: Push and release the Func/Mute button, so that it lights up, and push step button 9/Env 1 time.

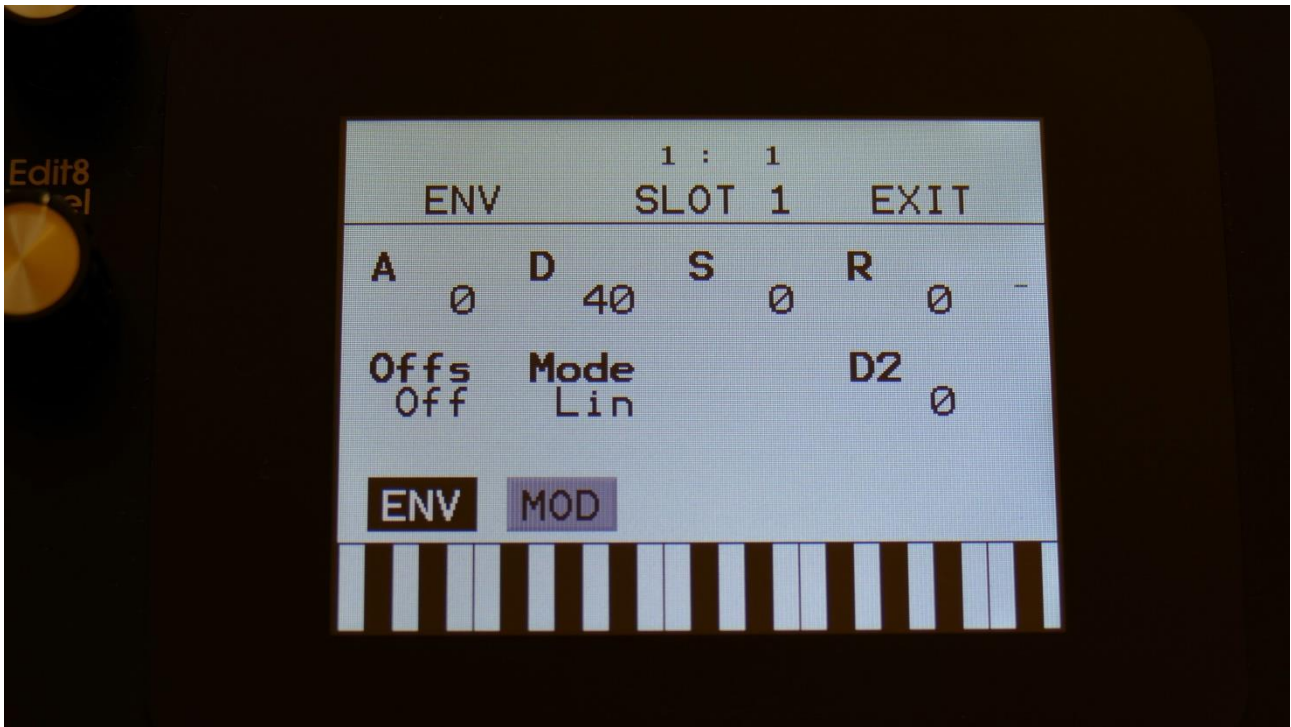

Touch the ENV touch button, to enter the envelope parameters page.

The VU-meter at the right of the screen, shows the Envelope output.

A: 0 to 511. Envelope 1 attack time. The time it will take the envelope to rise from zero to its maximum value, when a note event is received and held down.

D: 0 to 511. Envelope 1 decay time. When the envelope has reached its maximum value, in the time set by the attack parameter, it will decay, until it reaches the sustain level, and stay there, as long as the note that triggered it is held.

S: 0 to 511. Envelope 1 sustain level. Explained under the "Dec" parameter.

R: 0 to 511. Envelope 1 release time. The time it will take the envelope to decay from the value it is at, when a note off event are received, to zero.

Offs: Offset:

-Off: The envelope will work around the zero point, and apply both negative and positive modulation to the parameters affected by it.

-On: Positive only, offset added. The envelope will only work above the zero point, and will only add to the values of the parameters affected by it.

Mode: Selects if the envelope curve should be linear (**Lin**), or logarithmic (**Log**). The logarithmic curve gives the envelope a softer and less “clicky” attack.

D2: 0 to 511. Envelope 2 decay time. The time it will take the decay envelope to decay, after it has been triggered.

Envelope Modulation

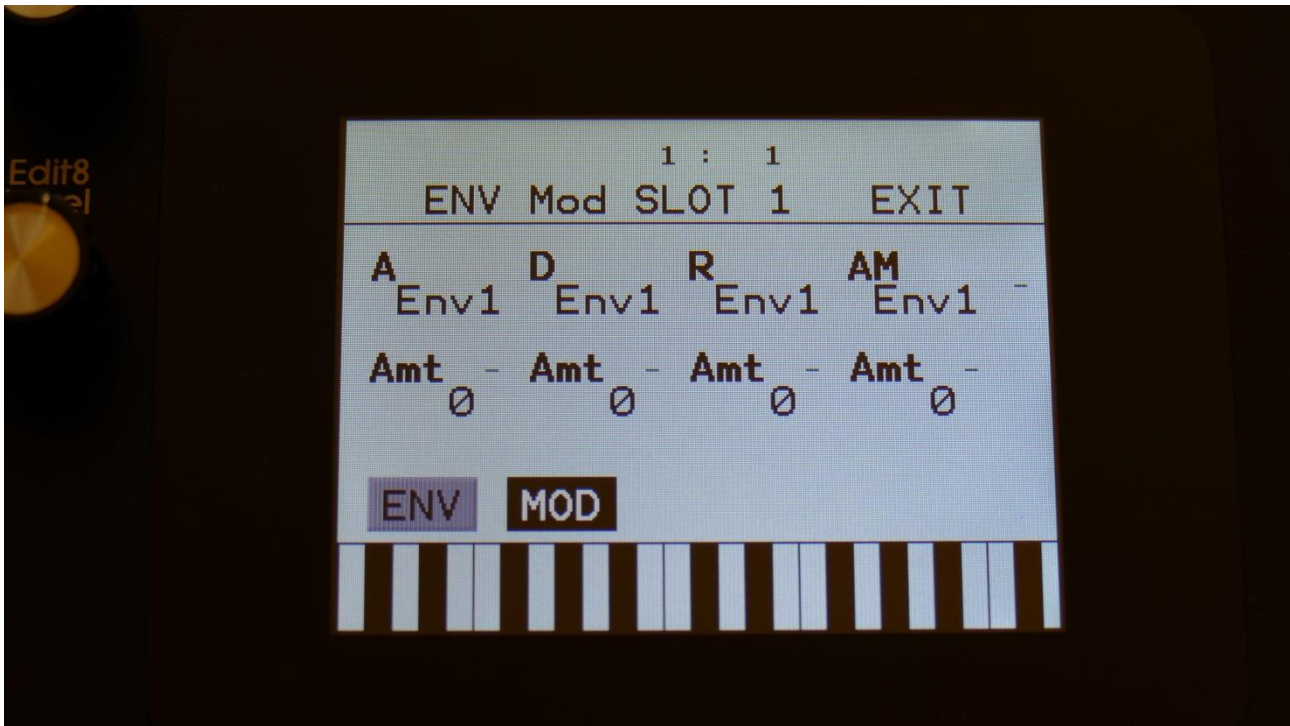

Touch the MOD touch button, to enter the envelope modulation page. OR: Push and release the Func/Mute button, so that it lights up, and push step button 9/Env 2 times.

The VU-meter at the right of the screen, shows the Envelope output. The small VU-meters next to the parameters, shows the activity of the selected modulation sources.

For each parameter, that can be modulated, it is possible to select a modulation source, and to adjust the modulation amount. Only the positive modulation sources, can be selected by the Edit Knobs. To make a modulation source negative, touch the modulation source parameter. For a complete list of modulation sources, see the list in the start of this section.

A: Modulates the Envelope 1 attack time.

D: Modulates the Envelope 1 decay time.

R: Modulates the Envelope 1 release time.

AM: Modulates the Envelope 1 output amount.

LFO1 to 16

LD3 has 16 LFO's, that are global, so each LFO can modulate any of the 16 Synth parts.

The LFO's has continuously variable waveform and rate parameters. Both of these parameters can be modulated. The output level of the LFO's can also be modulated, and they can be key-synced.

One LFO are shown at a time on the LFO pages. LFO 1 to 16 are selected in the same way as synth parts are, by pushing and holding the Steps/Part button, while pressing a step button. The LFO's are though selected separately from the parts. So LFO 5 can for instance be selected, while part 3 is selected.

LFO parameters

From the synth part main page, touch the LFO block, to enter the LFO pages. OR: Push and release the Func/Mute button, so that it lights up, and push step button 10/LFO 1 time.

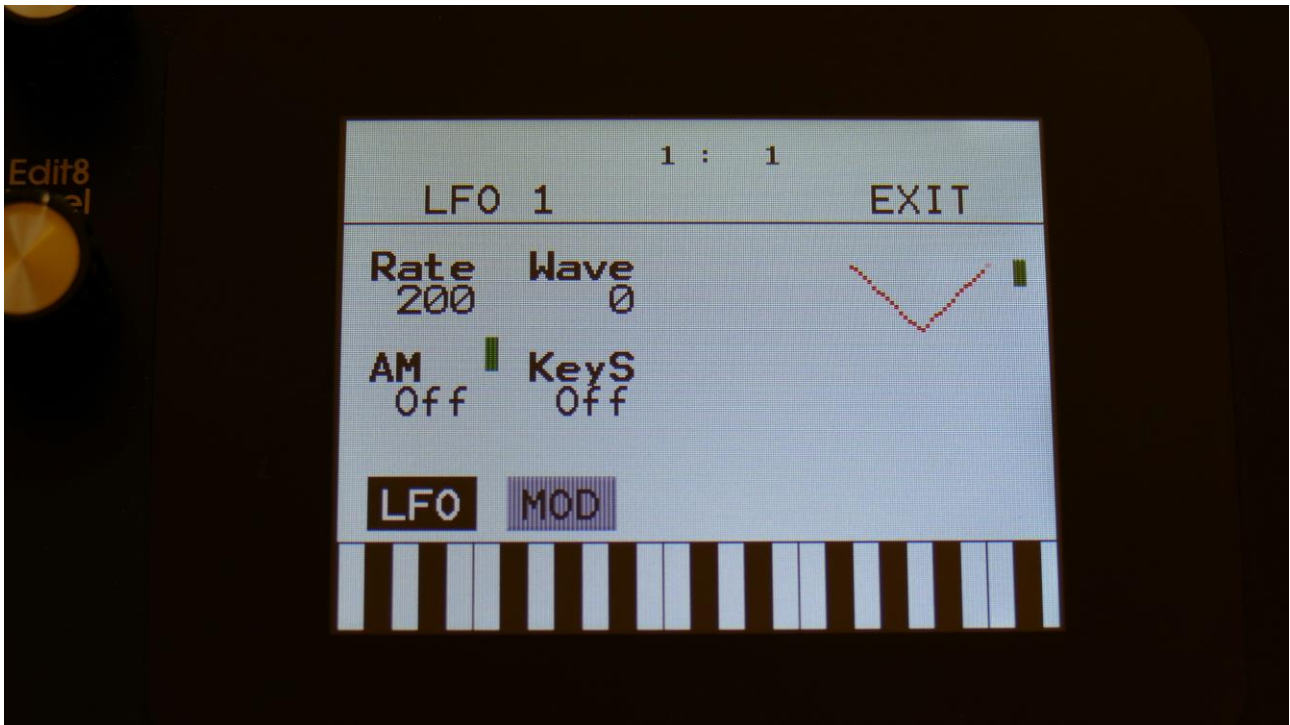

Touch the LFO touch button, to select this page.

At the right of this page, the current LFO waveform is shown, together with a small VU-meter, showing the LFO output activity.

Rate: 0 to 511. LFO rate. Sets the speed of the LFO.

Wave: 0 to 511. LFO output waveform. Morphs between triangle, sawtooth, square, pulse and FM waveforms. The FM waveforms are high frequency waves, that can be used for FM synthesis.

AM: Selects the modulation source, that will control the LFO output level. If "Off" is selected, no output level control will be applied to the LFO. Any modulation source can be selected. Please see list of modulation sources in the beginning of this section.

KeyS: Off, 1 to 16: LFO key sync.

Off: The LFO is free running.

1 to 16: Every time this Synth part is triggered, the LFO will reset to its initial value, and start over.

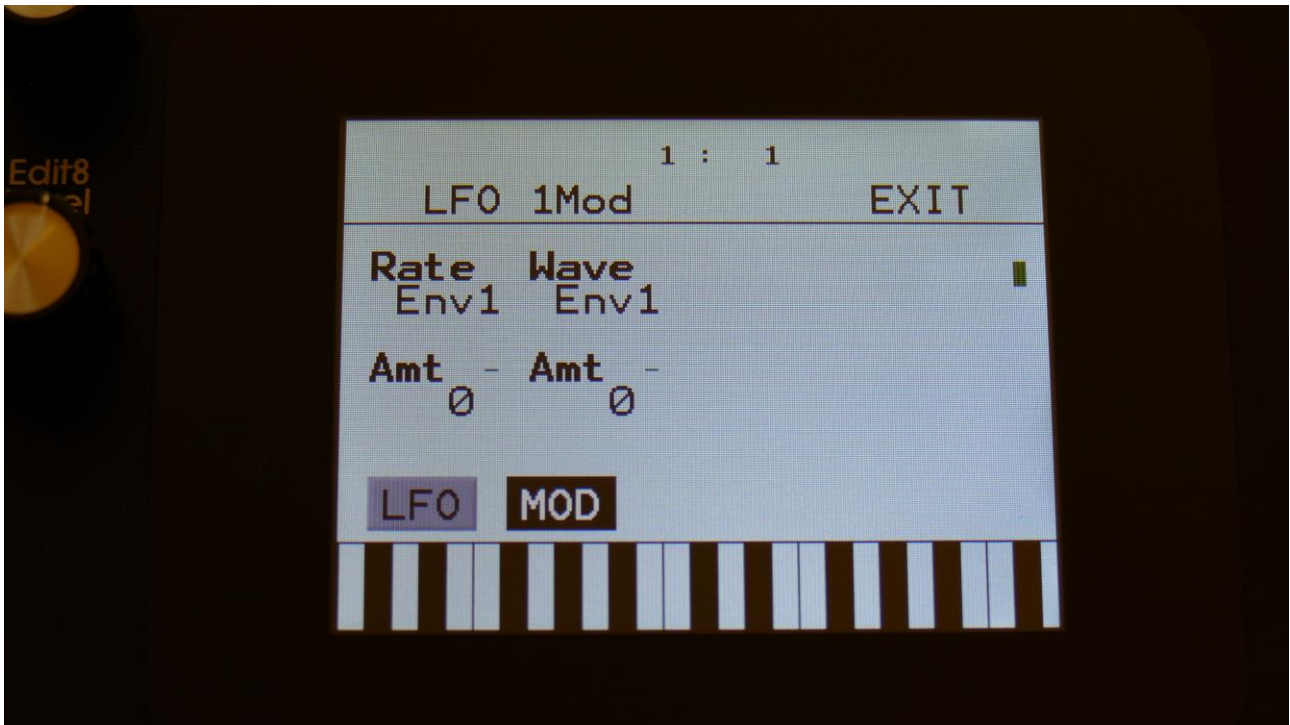

Touch the MOD touch button, to select this page. OR: Push and release the Func/Mute button, so that it lights up, and push step button 10/LFO 2 times.

The VU-meter at the right of the screen, shows the LFO activity. The small VU-meters next to the parameters, shows the activity of the selected modulation sources.

For each parameter, that can be modulated, it is possible to select a modulation source, and to adjust the modulation amount. Only the positive modulation sources, can be selected by the Edit Knobs. To make a modulation source negative, touch the modulation source parameter. For a complete list of modulation sources, see the list in the start of this section.

The upper row of parameters selects the modulation sources, **the lower row of parameters** (Labelled Amt) adjusts the modulation amount in the range 0 to 511.

The parameters on this page:

Rate: Modulates the LFO rate.

Wave: Modulates the LFO waveshape.

Audio Inputs Setup

Each audio input on LD3, can input to an audio bus. The setup of this, is done in this section.

From the synth parts main page, touch INP, to enter this page:

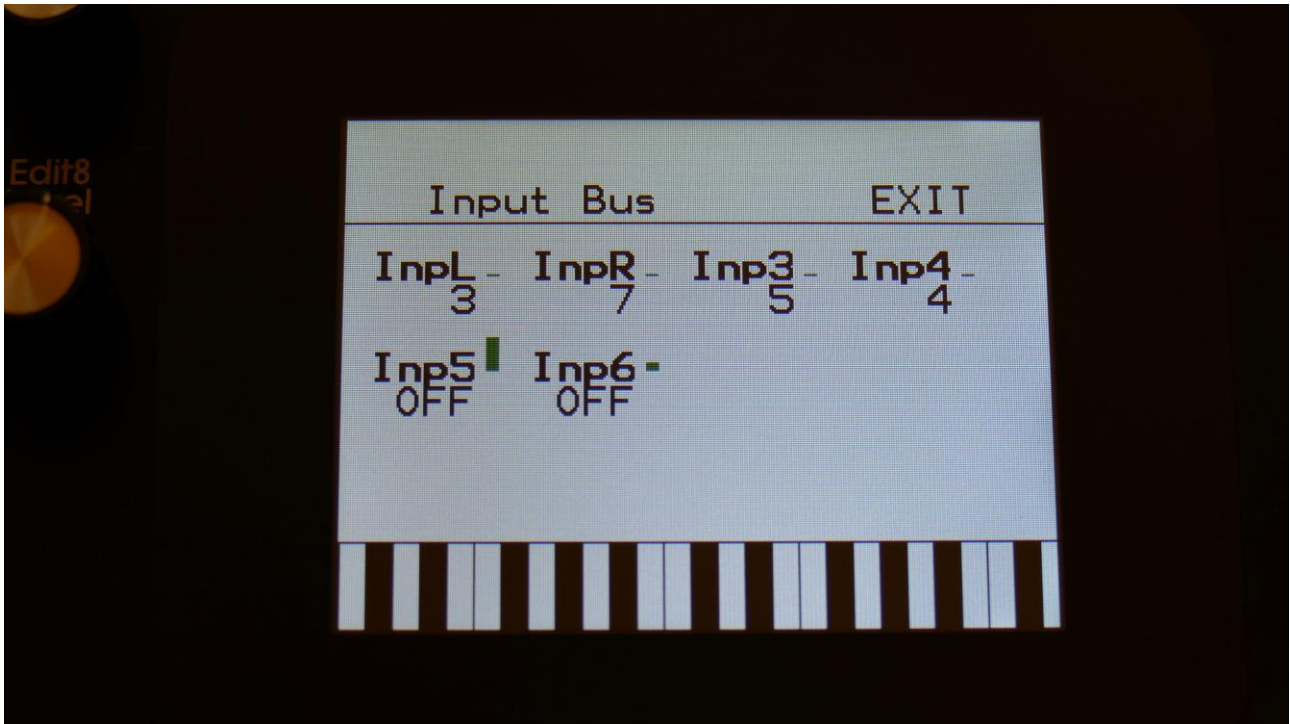

InpL, InpR, Inp3, Inp4, Inp5, Inp6: Off, 1 to 8. Sets the audio bus, that the corresponding audio input is sent to. When set to off, the audio input is not sent to any bus.

Analog FilterBoards (Optional)

Several different analog options are available for LD3. Some of them will add room for 2 analog filterboards. The SPAZEboards will add up to 4 analog filters to LD3.

The analog filters can be placed on audio busses, to process the signals applied to these. They will be placed before any insert effects on the same bus.

Modulation can be applied from any of the 16 synth parts.

FilterBoards

If analog option 1 or 3 are installed in your LD3, it has room for 2 analog filterboards. For instructions on how to install analog options and filterboards, see the section regarding this later in this manual. If you ordered an analog option and filterboards together with your LD3, it will all be installed, when you receive it.

Most of the parameters of the analog filters can be adjusted and modulated. The analog options of LD3 also adds a G-Ray digital/analog feedback circuit to the filters. This creates a kind of intermodulated feedback signal, and makes it possible to create sounds similar to FM plus new and never heard before sounds.

To make sure that the parameters on the pages fits the installed filterboards, some filters needs to be configured. This is done in the "MOR" section. If you ordered your LD3 together with the analog filterboards, this has already been configured.

From the synth parts main page, touch MOR on the top navigation bar. On the MOR page, touch VCF TYPES, to enter this page:

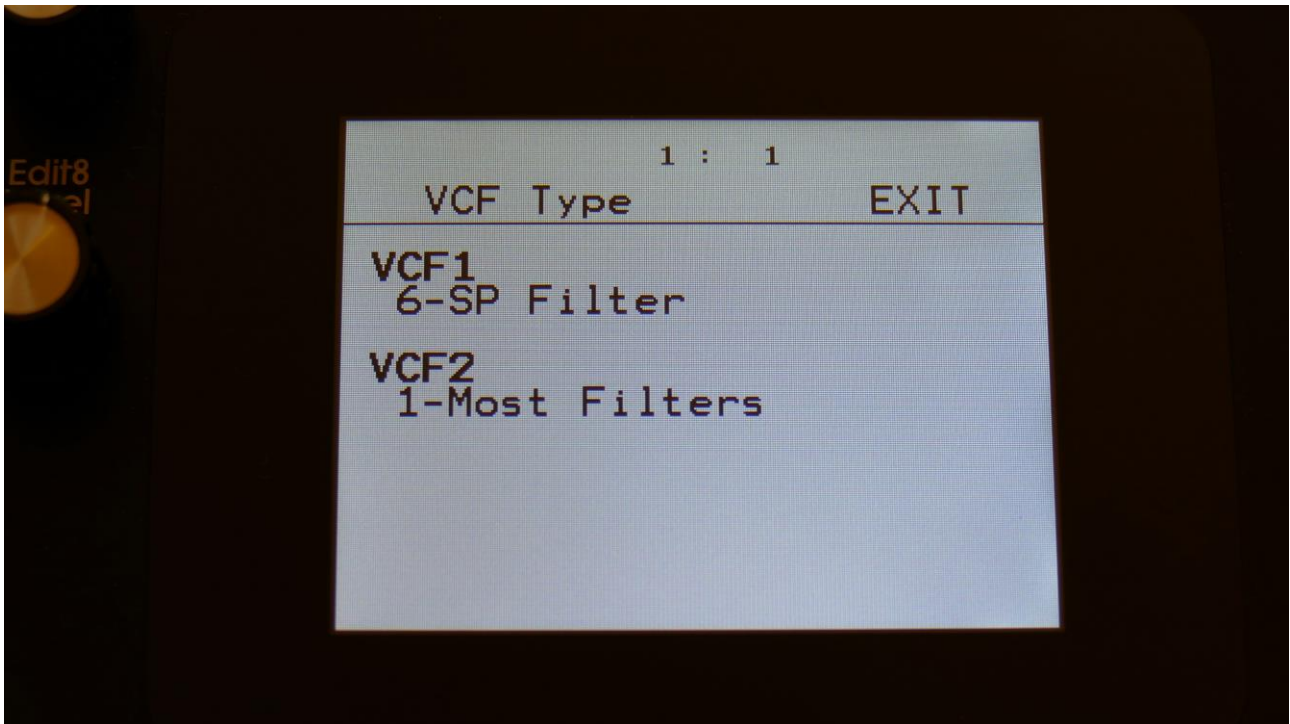

Here you can set the **VCF1** and **VCF2** parameters, by adjusting edit knob 1 and 5, to set up which filterboards are installed in slot 1 and 2.

VCF1, 2, 3, 4 and 9 should be set to 1-Most Filters.

The MiniProphet filter should be set to 5-MiniProphet.

The SP Filter should be set to 6-SP Filter.

The Tubaz filter should be set to 7-Tubaz.

The Dual Band SSI filter should be set to 8-Dual Band SSI.

Parameters **Brd2** and **Brd3** will be present in the right side of this page. These are only used, if SPAZEboard2 are installed, and will be explained in the Spazeboard2 chapter of this manual.

Analog Filterboards Parameters

From the synth parts main page, touch the VCFs block, to enter the analog filter pages. OR: Push and release the Func/Mute button, so that it lights up, and push step button 7/Filter 2 times.

The VCF page, when VCF1, 2, 3, 4 or 9 are installed:

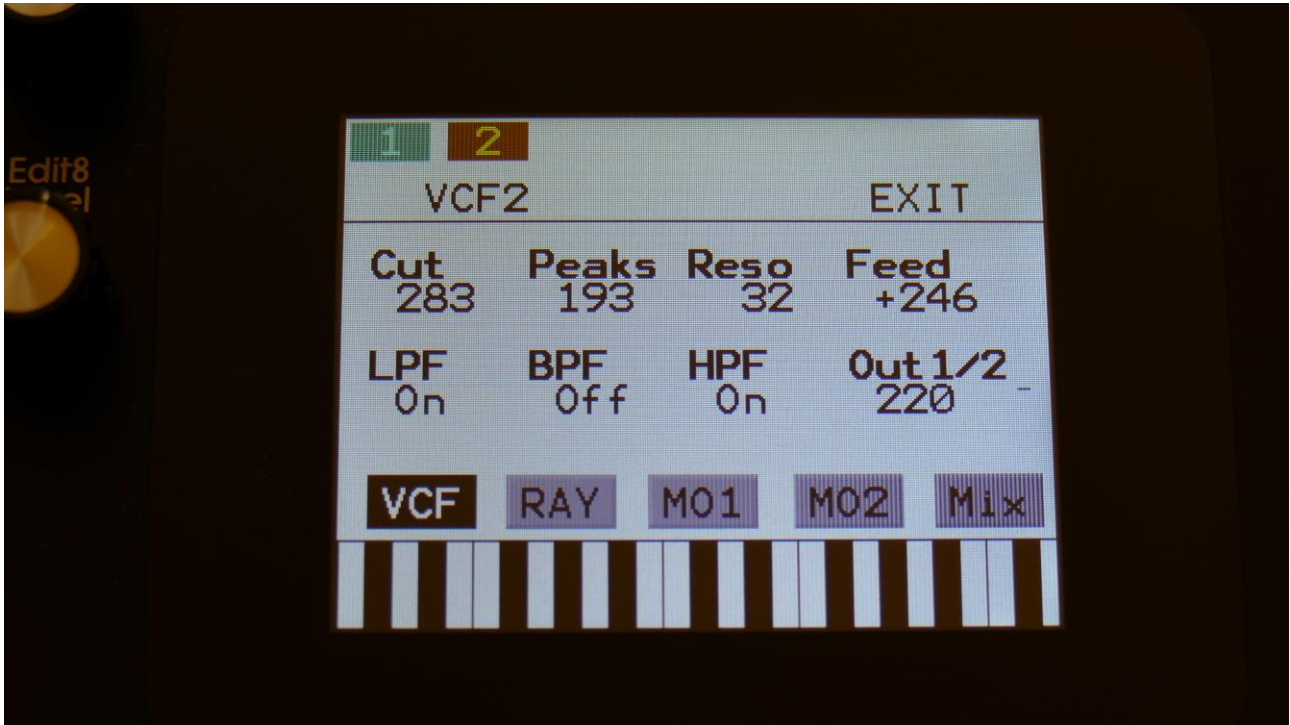

Filterboard 1 and 2 are selected by touching the square fields in the upper left corner of the screen, marked 1 and 2, NOT by the part select buttons.

Touch the VCF touch button, to enter this page.

The VU-meter at the right of the screen, shows the filter output activity.

Cut: 0 to 511. Adjust the filter cutoff frequency.

Peaks: 0 to 511.

On single filters: If the filter has more than one filter block, this will adjust the cutoff frequency offset of block 2 or block 3+4. If the filter has only one block (see the documentation for the filter), this will have no function.

On dual filters: This will adjust the cutoff frequency offset of filter 2.

On tripple filters: This will adjust the cutoff frequency offset of the middle filter, which is usually a bandpass filter.

On VCF9: This will adjust the Distortion Drive.

Reso: Adjusts the resonance of the filter. On dual and tripple filters, this adjusts the resonance on all filters.

Feed:

On single filters: This will adjust the feedback of the filter. – means negative feedback, + means positive feedback, 0 means no feedback.

On dual filters: This will adjust the negative feedback of the filter. -256 means no feedback, +255 means full negative feedback.

On tripple filters: This will adjust the cutoff frequency of the third filter (HPF).

LPF, BPF, HPF:

On single filters: Switches on and off the low pass, band pass and high pass outputs on the filter. At least one of these must be on, to get a sound out of the filter.

On dual filters: Switches on and off the low pass, band pass and high pass outputs of filter 2. Filter 1, which is a band pass filter on VCF2, is always on.

On tripple filters: Switches on and off the low pass, band pass and high pass outputs of filter 1, 2 and 3. The tripple filter has 3 separate filters, to generate each of these outputs, and their cutoff frequency can be separately adjusted.

Out1/2:

On single and dual filters: Mix between the clean filter sound, and the filter sound with added analog distortion.

On tripple filters: Mix between LPF + BPF + HPF and 3x BPF.

The VCF page, with VCF 5, MiniProphet filter installed:

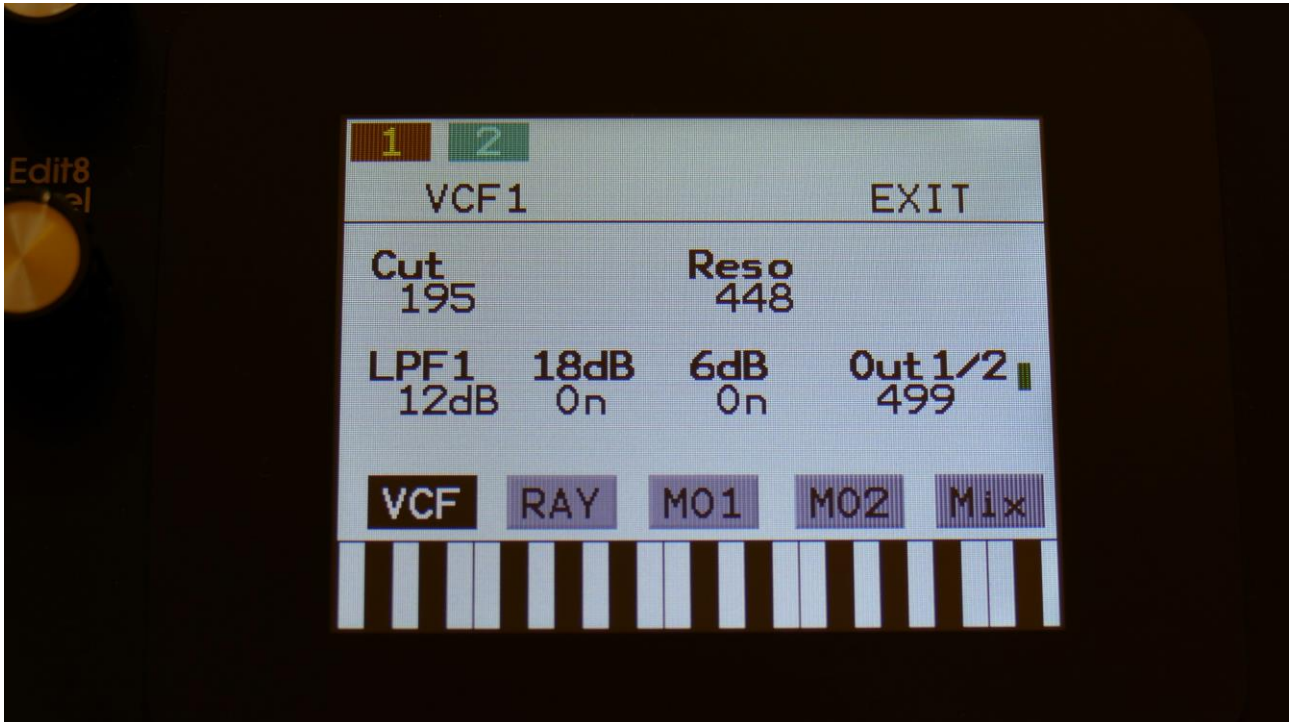

Touch the VCF touch button, to enter this page.

The VU-meter at the right of the screen, shows the filter output activity.

Cut: 0 to 511. Adjust the filter cutoff frequency.

Reso: 0 to 511. Adjusts the resonance of the filter.

LPF1: Switches filter output 1 between 24dB and 12dB steepness.

18dB: Switches the 18dB lowpass block on filter output 2 on or off. The phase of this is inverted compared to the phase of the 12 and 24 dB outputs on output 1, so when mixing with these, different filter modes can be obtained.

6dB: Switches the 6dB lowpass block on filter output 2 on or off. The phase of this is inverted compared to the phase of the 12 and 24 dB outputs on output 1, so when mixing with these, different filter modes can be obtained.

Out1/2: Mixes between the filter outputs 1 (12dB/24dB) and 2 (Inversed 6dB/18dB).

The VCF page, with VCF 6, SP filter installed:

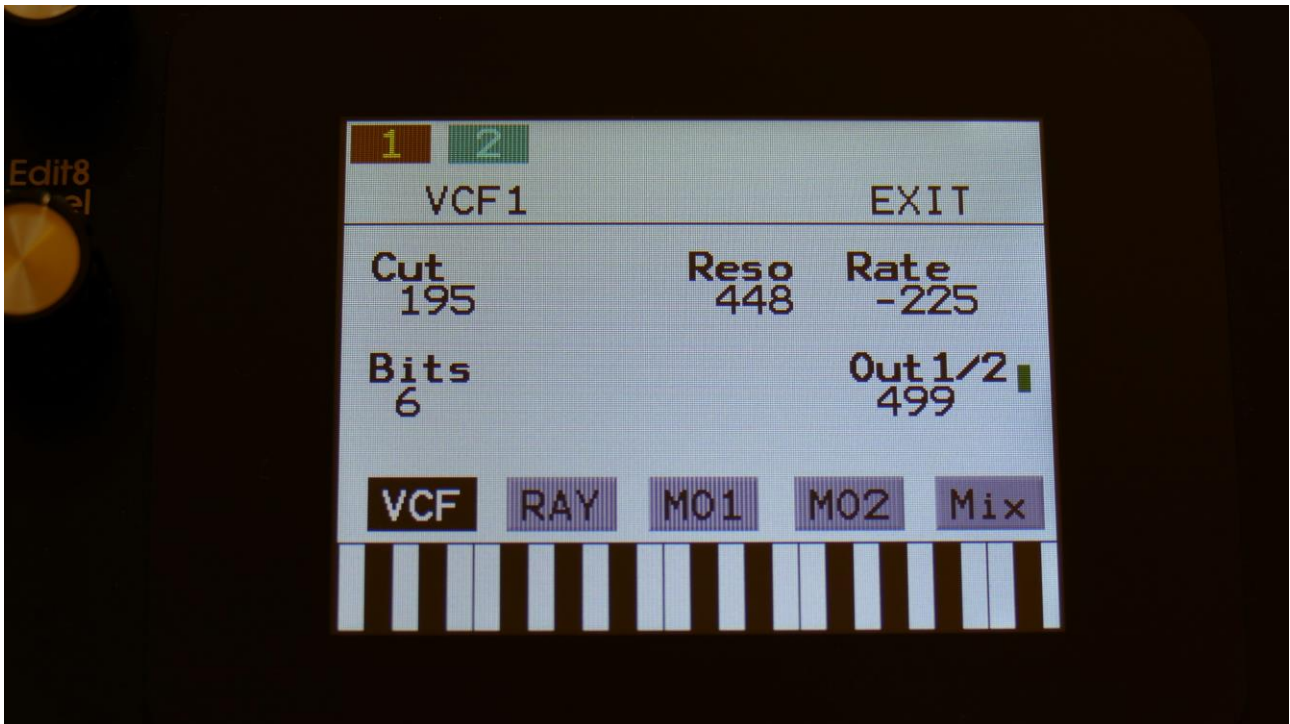

Touch the VCF touch button, to enter this page.

The VU-meter at the right of the screen, shows the filter output activity.

Cut: 0 to 511. Adjust the filter cutoff frequency.

Reso: 0 to 511. Adjusts the resonance of the filter.

Rate: Sample Rate. 0 to 60 KHz.

Bits: Bit depth. 12 or 6 bit.

Out1/2: Adds an analog Fuzz effect, when turned up.

The VCF page, with VCF 7, Tubaz filter installed:

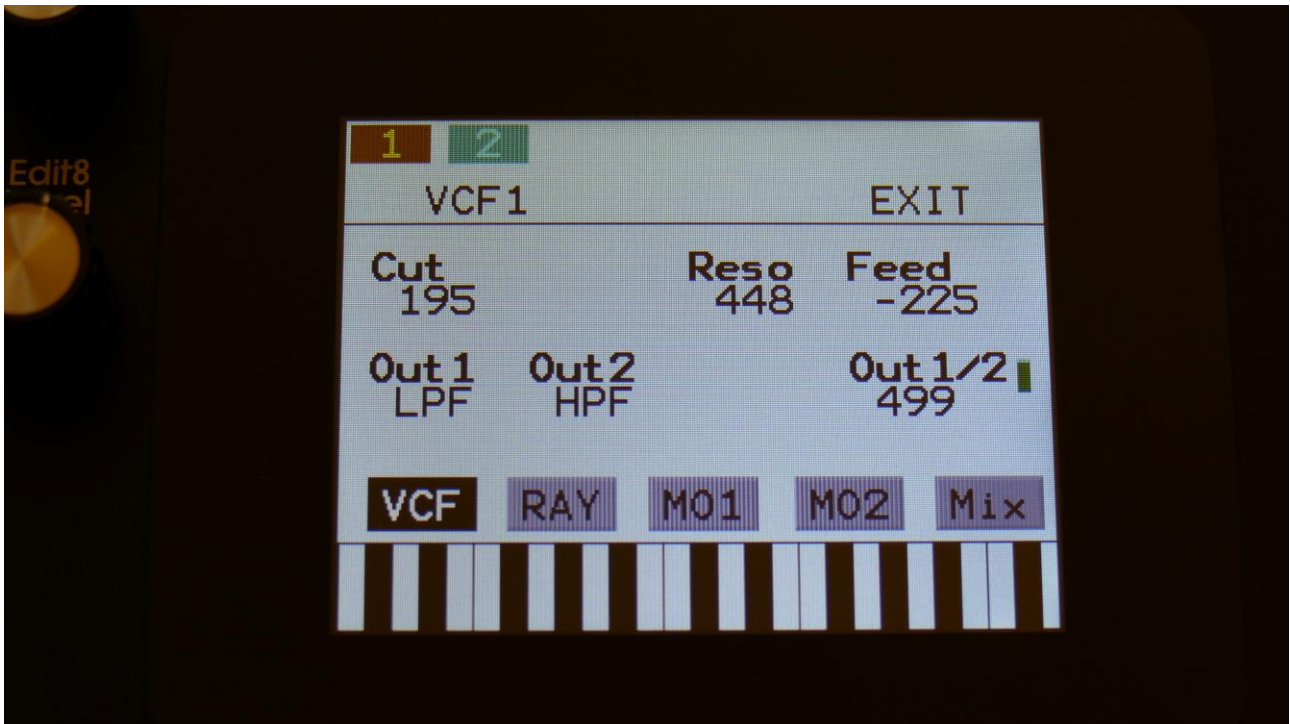

Touch the VCF touch button, to enter this page.

The VU-meter at the right of the screen, shows the filter output activity.

Cut: 0 to 511. Adjust the filter cutoff frequency.

Reso: 0 to 511. Adjusts the resonance of the filter.

Cut3/Feed: -256 to +255. Negative feedback.

Out1: BPF or LPF select.

Out2: Always HPF.

Out1/2: Mix between filter output 1 (BPF/LPF) and filter output 2 (HPF).

The VCF page, with VCF8, Dual Band SSI filter installed:

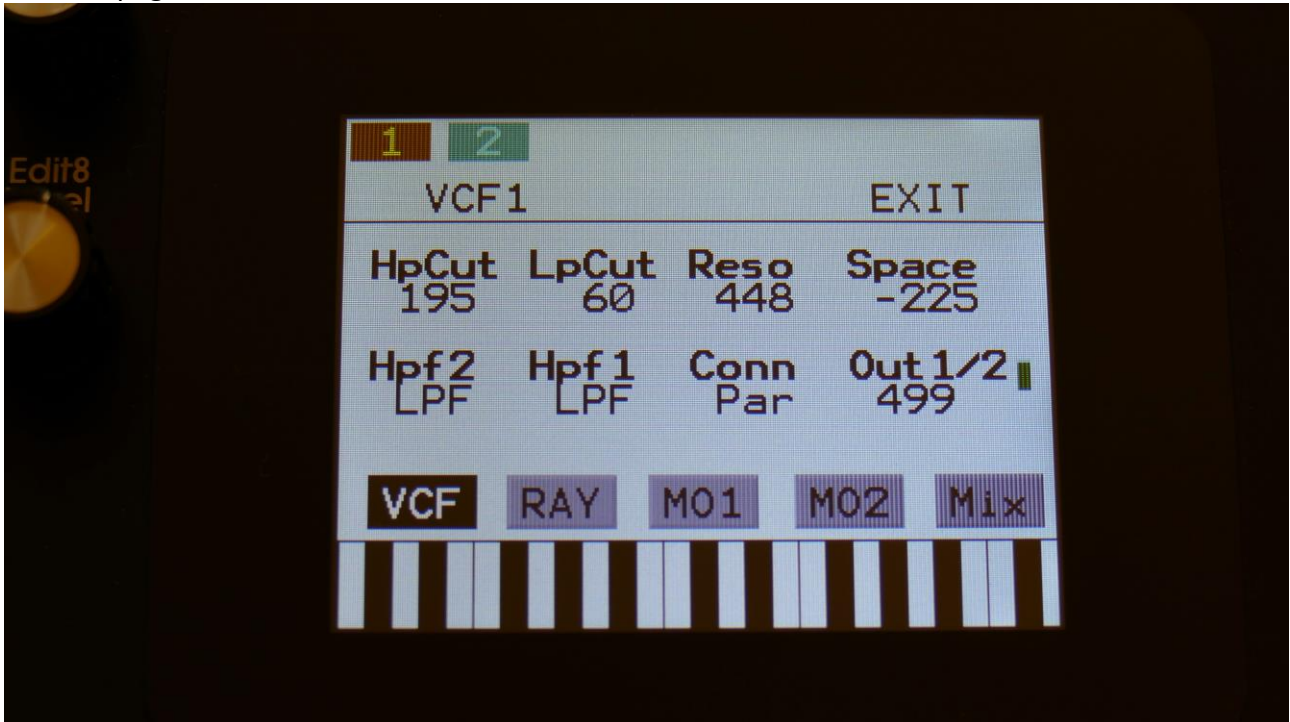

Touch the VCF touch button, to enter this page.

The VU-meter at the right of the screen, shows the filter output activity.

HpCut: HPF/LPF 1 and 2 filter cutoff frequency. Space between the 2 filters can be adjusted with Space.

LpCut: LPF 1 and 2 filter cutoff frequency. Space between the 2 filters can be adjusted with Space.

Reso: Filter resonance of all 4 filters.

Space: Space between the cutoff frequencies of the two filter chains.

HPF2: HPF2 filter mode HPF or LPF.

HPF1: HPF1 filter mode HPF or LPF.

Conn: Connection of the 2 filter chains. Ser (serial) or Par (parallel).

Out1/2: Mix between filter output 1 (HPF/LPF + LPF chain 1) and filter output 2 (HPF/LPF + LPF chain 2).

Analog Filterboards G-Ray page



Touch the RAY touch button, to enter this page.

The VU-meter at the right of the screen, shows the filter output activity.

G-Ray: Adjusts the amount of g-RAY intermodulation. 0: no g-RAY, 3: max g-RAY. Range: 0 to 3.

Mode: G-Ray mode.

-**Norm:** Normal 1:1 feedback.

-**Neg:** 1:1 feedback with the signal inverted (a 180 degree phase shift)

-**Ultr:** Boosted feedback.

-**Uneg:** Boosted feedback with the signal inverted (a 180 degree phase shift)

Feed: 0 to 511. G-Ray feedback level.

FmBus: 1 to 8. The audio bus, that will apply the audio signal for FM.

Peaks: Selects how the Peaks parameter should interact with the Cutoff frequency parameter:

-**Add:** The value of the Peaks parameter is added to the Cutoff value.

-**Sub:** The value of the Peaks parameter is subbed from the Cutoff value.

-**Alig:** The value of the Peaks parameter are alligned around the Cutoff value.

-**Sepa:** The value of the Peaks parameter are a totally separate value, and are not affected by the Cutoff value.

Cut3: Selects the function of the Feed/Cut3 parameter:

-Feed: The value of the Feed/Cut3 parameter are a totally separate value, and are not affected by the Cutoff value. This setting is the recommended one, when a single or a dual filter are installed, and the Feed/Cut3 should work as Feed.

The next possible modes, are mostly usable, when a tripple analog filter are installed:

-Add: The value of the Feed/Cut3 parameter is added to the Cutoff value.

-Sub: The value of the Feed/Cut3 parameter is subbed from the Cutoff value.

-Alig: The value of the Feed/Cut3 parameter are alligned around the Cutoff value.

Out2: Selects whether output 2 of the analog filter should be normal (**Nrm**) or inverted (**Inv**). Sometimes it can get some great effects, when inverting output 2 of the filter, and adjust the Out1/2 mix.

FM: 0 to 511. The amount of frequency modulation (audio range), that are applied to all of the filter cutoff frequencies, from the audio Bus selected by the FmBus parameter.

Analog Filterboards Modulation 1

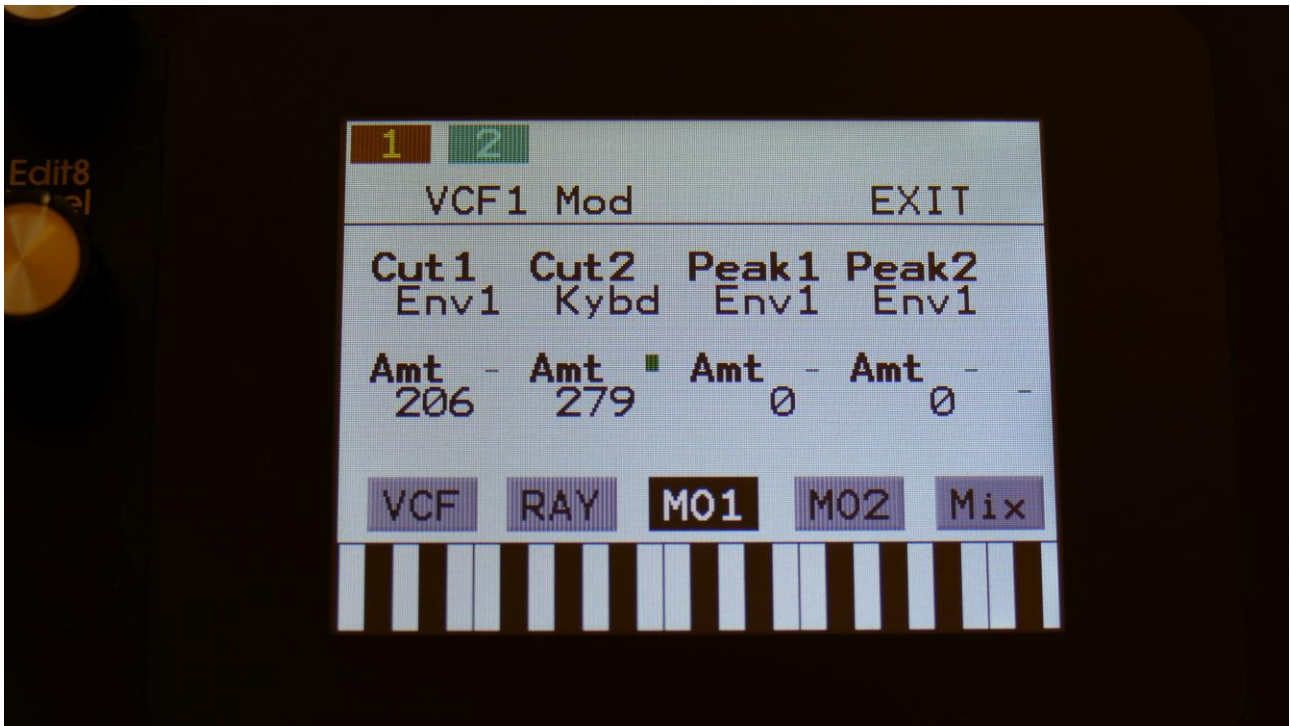

Touch the MO1 touch button, to enter this page.

The VU-meter at the right of the screen, shows the filter output activity.

For each parameter, that can be modulated, it is possible to select a modulation source, and to adjust the modulation amount. Only the positive modulation sources, can be selected by the Edit Knobs. To make a modulation source negative, touch the modulation source parameter. For a complete list of modulation sources, see the list in the start of this section.

The upper row of parameters selects the modulation sources, **The lower row of parameters** (Labelled Amt) adjusts the modulation amount in the range 0 to 511.

Cut1, Cut2: Will modulate the Cutoff Frequency.

Peak1, Peak2: Will modulate the Peaks parameter.

Analog Filterboards Modulation 2

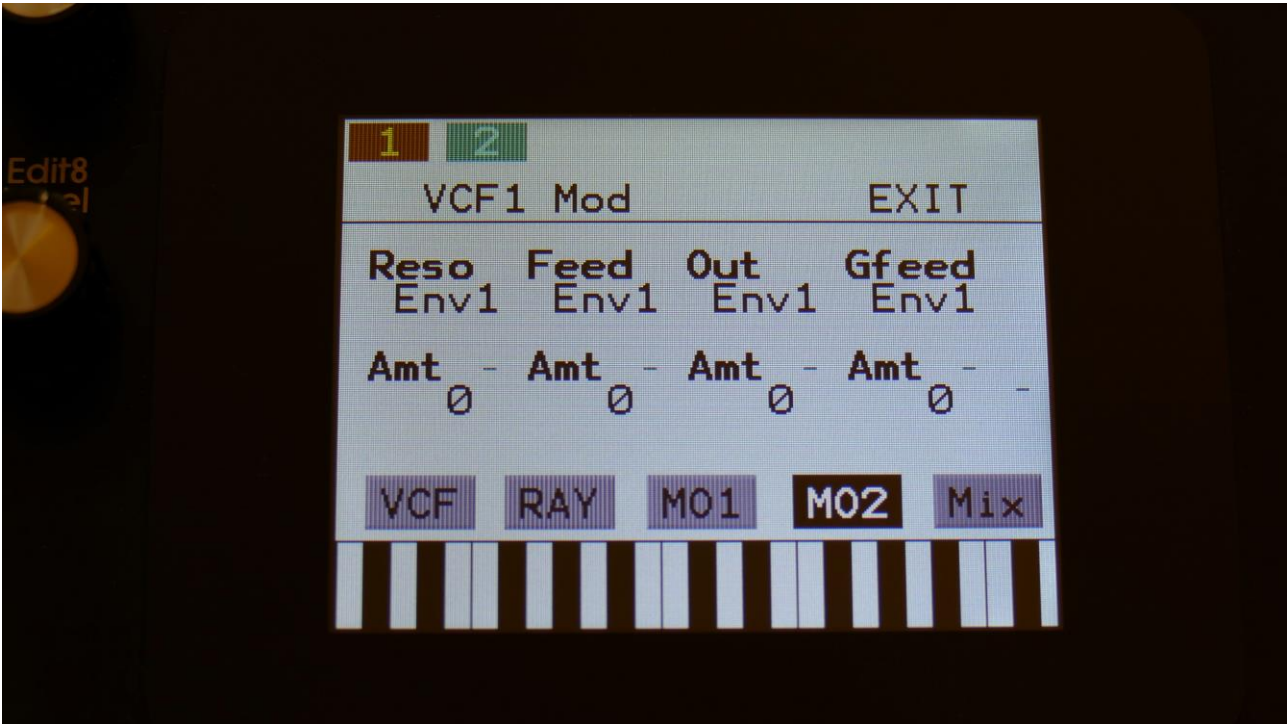

Touch the MO2 touch button, to enter this page.

The VU-meter at the right of the screen, shows the filter output activity.

For each parameter, that can be modulated, it is possible to select a modulation source, and to adjust the modulation amount. Only the positive modulation sources, can be selected by the Edit Knobs. To make a modulation source negative, touch the modulation source parameter. For a complete list of modulation sources, see the list in the start of this section.

The upper row of parameters selects the modulation sources, **The lower row of parameters** (Labelled Amt) adjusts the modulation amount in the range 0 to 511.

Reso: Will modulate the amount of resonance applied to all filters.

Feed: Will modulate the analog filter feedback/Cutoff frequency 3.

Out: Will modulate the Out1/2 mix parameter.

Gfeed: Will modulate the amount of G-Ray feedback applied.

Analog Filterboards Mix/Setup

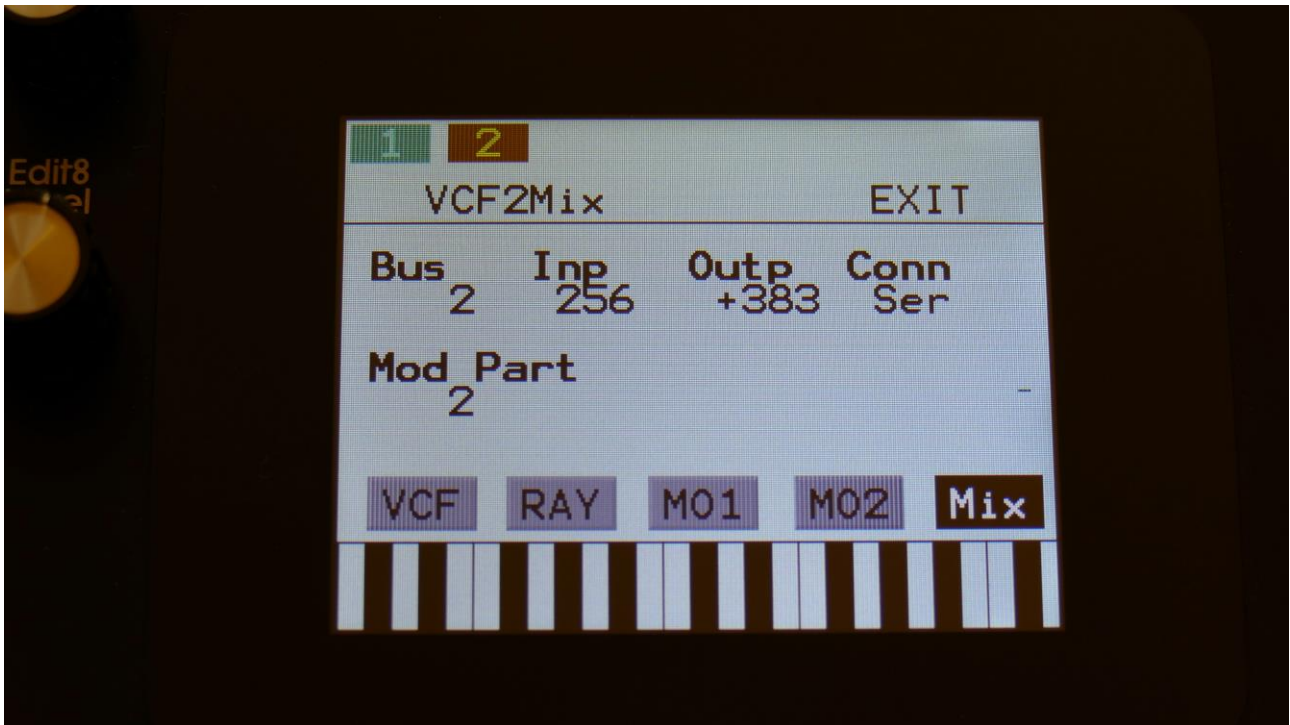

Touch the MO2 touch button, to enter this page.

The VU-meter at the right of the screen, shows the filter output activity.

Bus: 1 to 8. The audio Bus, that the filter will be placed on.

Inp: 0 to 511. The audio input level for the filters.

Outp: -128 to +383. The output level of the filters.

Conn: Ser/Par. (Only on VCF2). Places this filter in either serial or parallel to VCF1.

ModPrt: 1 to 16. The part from which, the filter modulation sources will be added.

SPAZEboard 2

This section describes the functionality of the SPAZEboard 2. For instructions on how to install the SPAZEboard, see the section regarding this later in this manual. If you ordered a SPAZEboard together with your LD3, it will all be installed, when you receive it.

Spazeboard 2 has 8 analog filters built in, plus room for 2 filterboards, arranged in 4 chains:

1: Two parallel lines, each with one 24 dB resonant highpass filter and one 24 dB resonant lowpass filter. 4 filters in total.

2: Any FilterBoard.

3: Any FilterBoard.

4: Two parallel lines, each with one 24 dB resonant highpass filter and one 24 dB resonant lowpass filter. 4 filters in total.

Each of the 4 filter chains can be assigned to any of the 8 audio busses. If more filters are assigned to the same bus, they can be serial or parallel connected to each other.

Most of the parameters of the Spazeboard filters can be adjusted and modulated. Each filter chain includes a G-Ray digital/analog feedback circuit. This creates a kind of intermodulated feedback signal, and makes it possible to create sounds similar to FM plus new and never heard before sounds.

When the CV and audio ins/outs expansion are installed together with SPAZEboard2, these have different functionality:

AUDIO IN/OUT 3, 4, 5 and 6 are separate audio outputs from analog VCF 1, 2, 3 and 4. For VCF 2 and 3, only the filterboards output 1 are outputted.

The CV Inputs has the same functionality, as with the analog board installed.

The CV outputs are:

1: VCF3 Feed parameter and modulation.

2: VCF3 Reso parameter and modulation.

3: VCF3 Cut parameter and modulation.

4: VCF3 Peaks parameter and modulation.

To make sure that the parameters on the filter pages fits the installed SPAZEboard, this needs to be configured. This is done in the "MOR" section. If you ordered your LD3 together with a Spazeboard, this has already been configured

From the synth parts main page, touch MOR on the top navigation bar. On the MOR page, touch VCF TYPES, to enter this page:

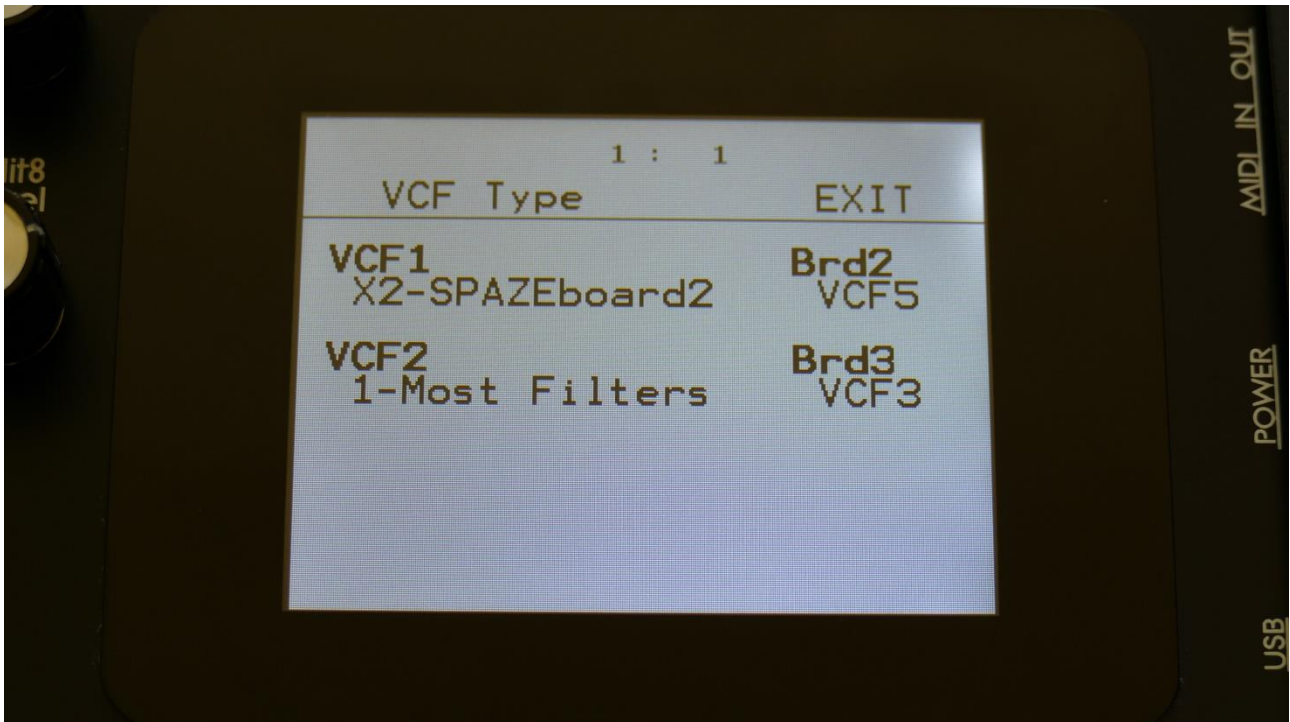

Here you, by adjusting edit knob 1, should set **VCF1** to be X2-SPAZEboard2.

The **Brd2** and **Brd3** parameters should be set to the Filterboard numbers, of the 2 Filterboards that are installed on your Spazeboard2.

Unlike the **VCF1** and **VCF2** parameters, the Spazeboard2 filterboards has an individual setup for each of the (currently) 9 available filterboards. So if you have filterboard 5 and 3 installed, you must select VCF5 and VCF3, as shown on the picture.

The setting of **VCF2** is ignored, when **VCF1** is set to SPAZEboard2.

SPAZEboard 2 Parameters

From the synth parts main page, touch the VCFs block, to enter the analog filter pages. OR: Push and release the Func/Mute button, so that it lights up, and push step button 7/Filter 2 times.

VCF1 and VCF4 –Dual Spaze filters

Each of the two dual Spaze filters has 2 filter lines, that each has a 24dB analog highpass filter, going into a 24 dB analog lowpass filter.



Filter chains 1, 2, 3 and 4 are selected by touching the square fields in the upper left corner of the screen, marked 1, 2, 3 and 4, NOT by the part select buttons.

Touch the VCF touch button, to enter this page.

The VU-meter at the right of the screen, shows the filter output activity.

HpCut: 0 to 511. The cutoff frequency of the highpass filters in both filter lines.

LpCut: 0 to 511. The cutoff frequency of the lowpass filters in both filter lines.

Reso: 0 to 511. The amount of resonance applied to all of the 4 filters.

Spaze: -255 to +256. The difference between the cutoff frequencies in the 2 lines of filters.

Inp: 0 to 511. The audio input level for the filters.

Outp: -128 to +383. The output level of the filters.

FM: 0 to 511. The amount of frequency modulation (audio range), that are applied to all of the filter cutoff frequencies, from the audio Bus selected by the FmBus parameter.

FmBus: 1 to 8. The audio bus, that will apply the audio signal for FM.

SPAZEboard 2, VCF1 and 4 G-Ray

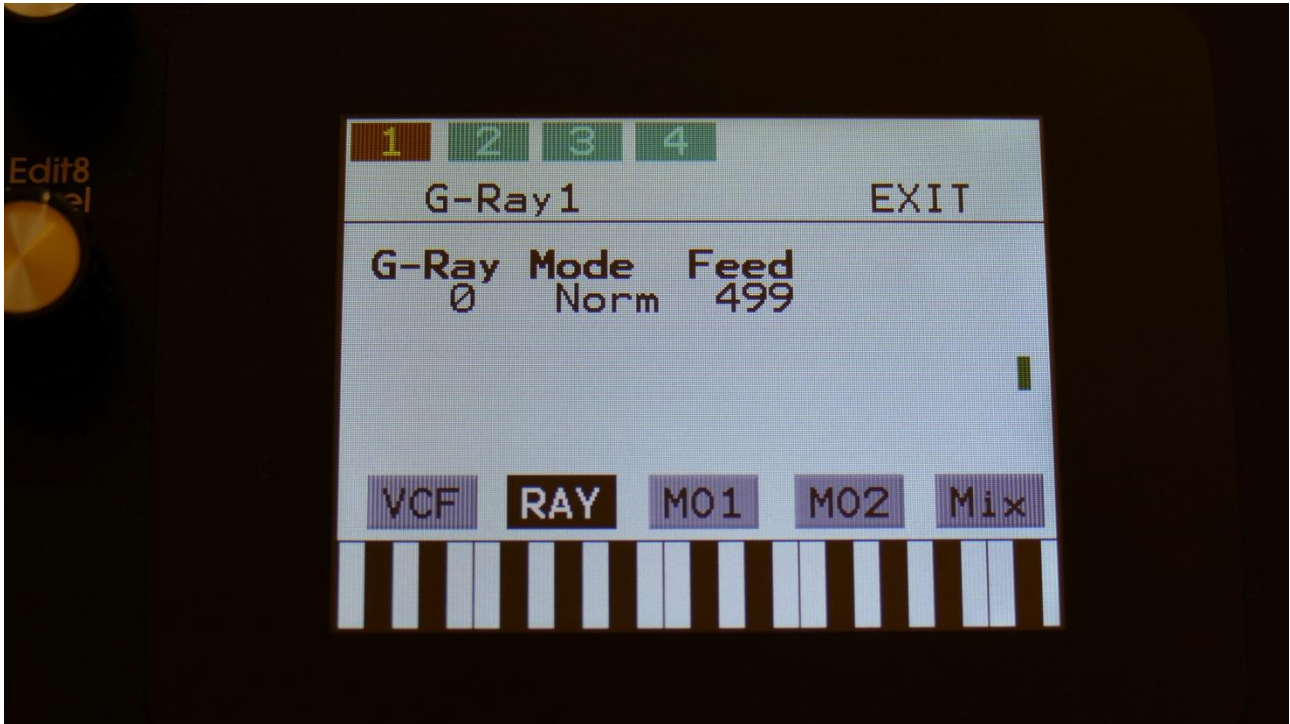

Touch the VCF touch button, to enter this page.

The VU-meter at the right of the screen, shows the filter output activity.

G-Ray: Adjusts the amount of g-RAY intermodulation. 0: no g-RAY, 3: max g-RAY. Range: 0 to 3.

Mode: G-Ray mode.

-**Norm:** Normal 1:1 feedback.

-**Neg:** 1:1 feedback with the signal inverted (a 180 degree phase shift)

-**Ultr:** Boosted feedback.

-**Uneg:** Boosted feedback with the signal inverted (a 180 degree phase shift)

Feed: G-Ray feedback level. Range: 0 to 511.

SPACEboard 2, VCF1 and 4 Modulation 1

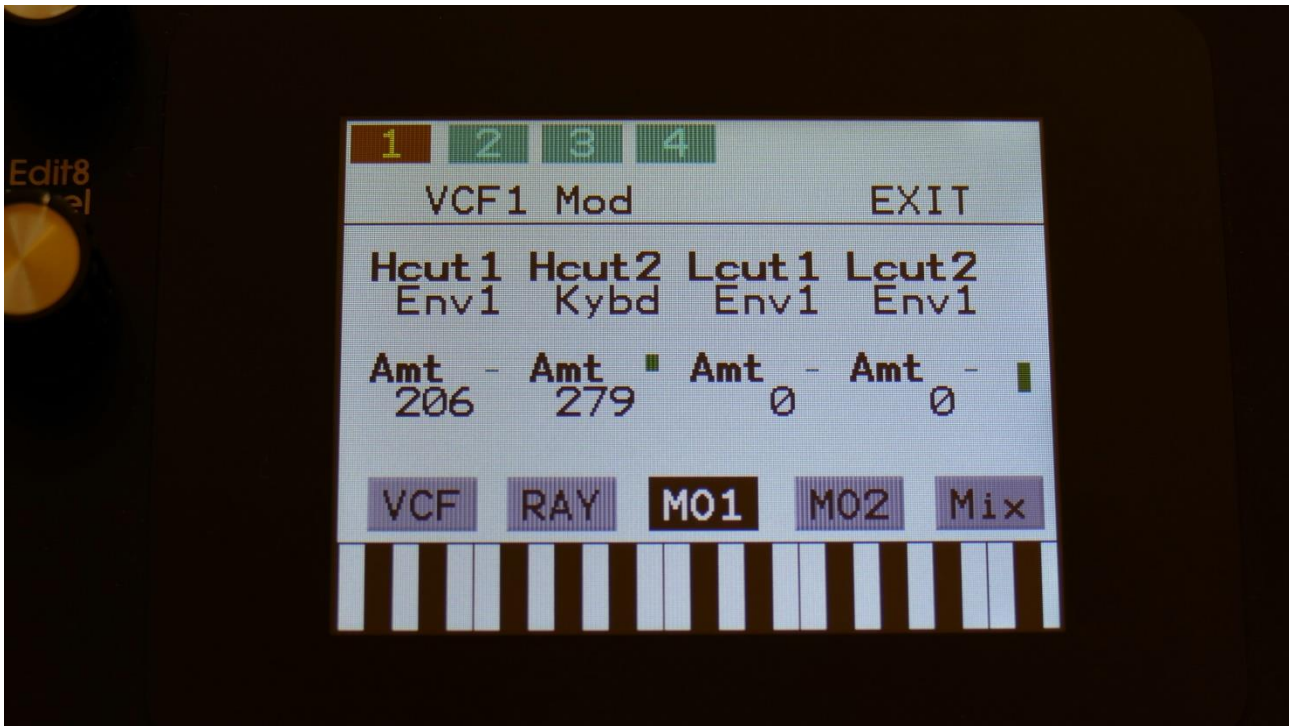

Touch the MO1 touch button, to enter this page.

The VU-meter at the right of the screen, shows the filter output activity.

For each parameter, that can be modulated, it is possible to select a modulation source, and to adjust the modulation amount. Only the positive modulation sources, can be selected by the Edit Knobs. To make a modulation source negative, touch the modulation source parameter. For a complete list of modulation sources, see the list in the start of this section.

The upper row of parameters selects the modulation sources, **The lower row of parameters** (Labelled Amt) adjusts the modulation amount in the range 0 to 511.

HCut1, HCut2: Will modulate the Cutoff Frequency of both the highpass filters.

LCut1, LCut2: Will modulate the Cutoff Frequency of both the lowpass filters.

SPACEboard 2, VCF1 and 4 Modulation 2



Touch the MO2 touch button, to enter this page.

The VU-meter at the right of the screen, shows the filter output activity.

For each parameter, that can be modulated, it is possible to select a modulation source, and to adjust the modulation amount. Only the positive modulation sources, can be selected by the Edit Knobs. To make a modulation source negative, touch the modulation source parameter. For a complete list of modulation sources, see the list in the start of this section.

The upper row of parameters selects the modulation sources, **The lower row of parameters** (Labelled Amt) adjusts the modulation amount in the range 0 to 511.

Reso: Will modulate the amount of resonance applied to all filters.

Spaze: Will modulate the difference between the cutoff frequencies of the 2 filter lines.

FFM: Will modulate the amount of frequency modulation applied to the cutoff frequencies of all the filters.

Gfeed: Will modulate the amount of G-Ray feedback applied.

SPACEboard 2, VCF1 and 4 Mix/Setup

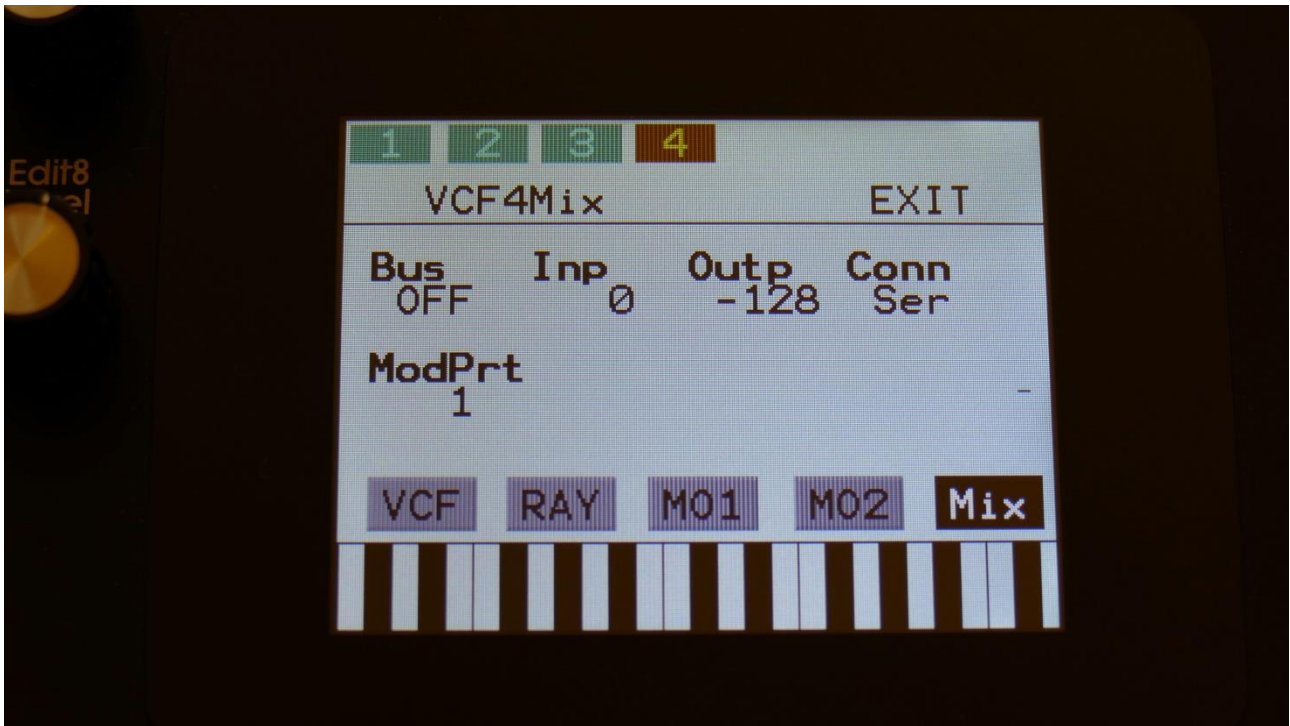

Touch the Mix touch button, to enter this page.

The VU-meter at the right of the screen, shows the filter output activity.

Bus: 1 to 8. The audio Bus, that the filter will be placed on.

Inp: 0 to 511. The audio input level for the filters.

Outp: -128 to +383. The output level of the filters.

Conn: Ser/Par. (Only on VCF2, 3 and 4). Places this filter in either serial or parallel connection to the lower numbered filter.

ModPrt: 1 to 16. The part from which, the filter modulation sources will be added.

SPACEboard 1, VCF2 and VCF3 – FilterBoards

On the VCF2 and 3 pages, when Spazeboard2 are installed, different parameters will be shown, depending on the Filterboards installed on your Spazeboard2.

The parameters for Filterboard 1, 2, 4 and 9:

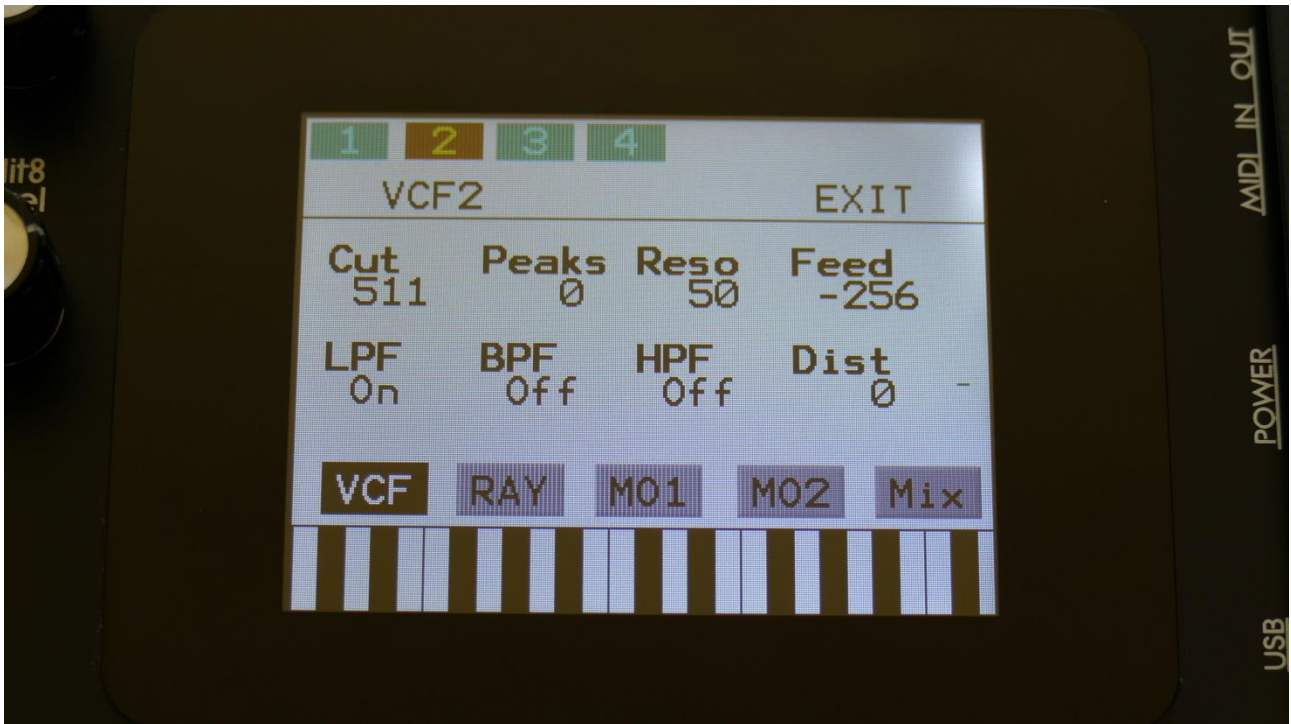

Select filter chain 2 or 3 by touching the square field in the upper left corner of the screen, marked 2 and 3.

Touch the VCF touch button, to enter this page.

The VU-meter at the right of the screen, shows the filter output activity.

Cut: 0 to 511. Adjust the filter cutoff frequency.

Peaks: 0 to 511.

On single filters: If the filter has more than one filter block, this will adjust the cutoff frequency offset of block 2.

On dual filters: This will adjust the cutoff frequency offset of filter 2.

On VCF9: This will adjust the distortion drive.

Reso: 0 to 511. Adjusts the amount of resonance applied to the filter. On dual filters, this adjusts the resonance on all filters.

Cut3/Feed: 0 to 511.

On single filters: This will adjust the feedback of the filter. – means negative feedback, + means positive feedback, 0 means no feedback.

On dual filters: This will adjust the negative feedback of the filter. -256 means no feedback, +255 means full negative feedback.

LPF, BPF, HPF: On/Off.

On single filters: Switches on and off the low pass, band pass and high pass outputs on the filter. At least one of these must be on, to get a sound out of the filter.

On dual filters: Switches on and off the low pass, band pass and high pass outputs of filter 2. Filter 1, which is a band pass filter on VCF2, is always on.

Dist: 0 to 511.

On single and dual filters: Mix between the clean filter sound, and the filter sound with added analog distortion.

For Filterboard 3:

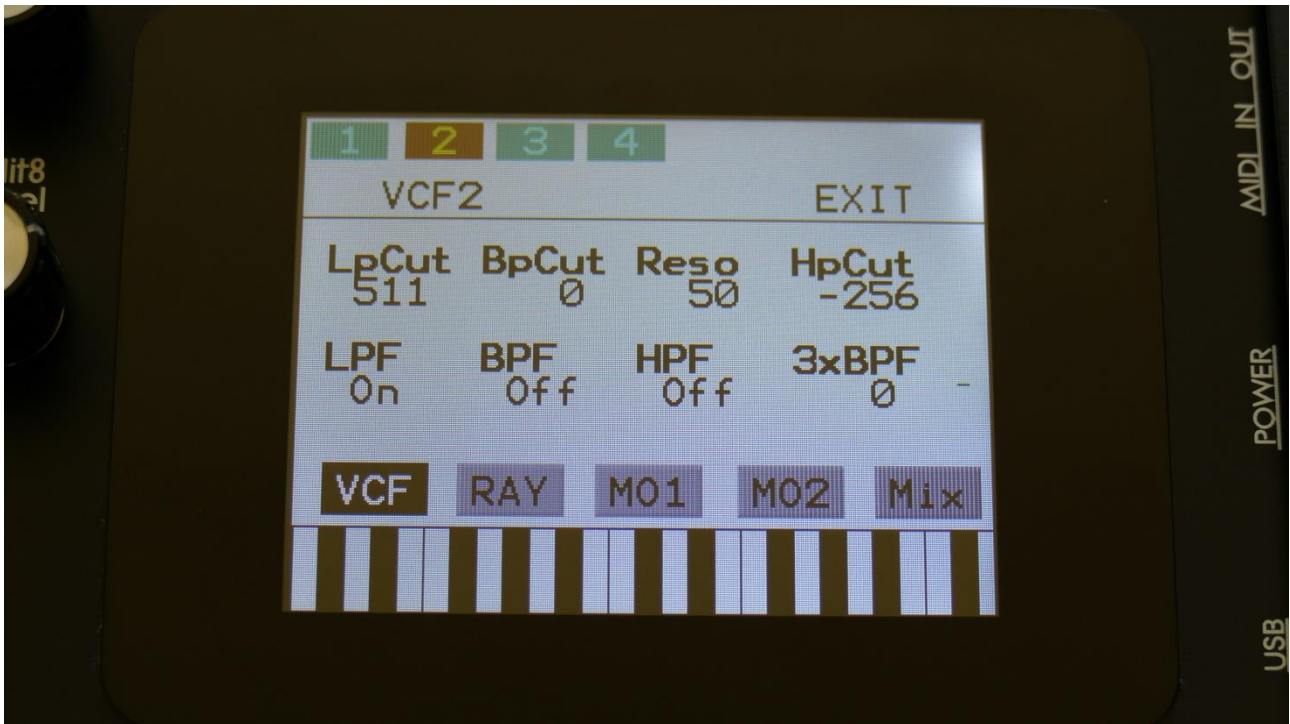

Select filter chain 2 or 3 by touching the square field in the upper left corner of the screen, marked 2 and 3.

Touch the VCF touch button, to enter this page.

The VU-meter at the right of the screen, shows the filter output activity.

LpCut: 0 to 511. Adjust the cutoff frequency for the LPF, or BPF1, when mixed to 2xBPF.

BpCut: 0 to 511. Adjust the cutoff frequency for the BPF, or BPF2, when mixed to 2xBPF.

Reso: Adjusts the resonance of all the 3 filters.

HpCut: 0 to 511. Adjust the cutoff frequency for the HPF, or BPF3, when mixed to 2xBPF.

LPF, BPF, HPF:

Separately switches on and off the low pass, band pass and high pass outputs of filter 1, 2 and 3. The outputs of the 2 band pass filters, when mixed to 3xBPF, are always on, regardless of these settings.

3xBPF: Mix between LPF + BPF + HPF and 3x BPF.

Filterboard 5 (MiniProphet):

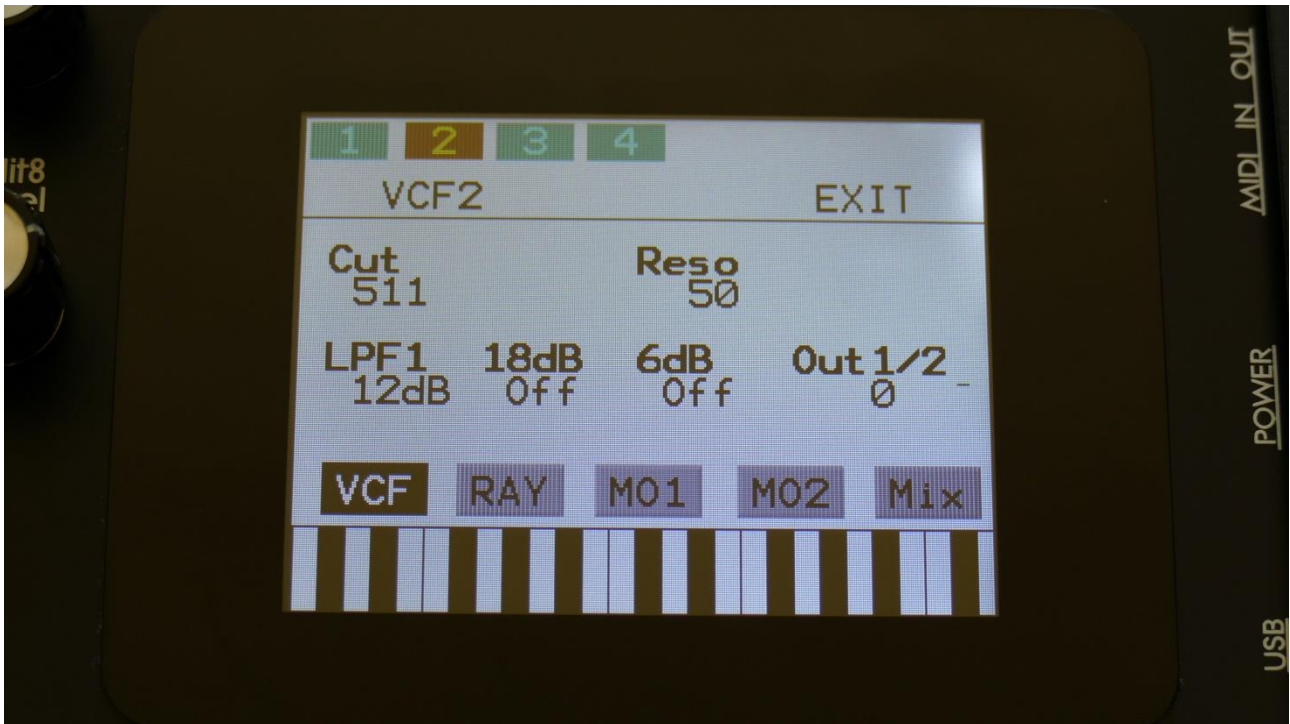

Select filter chain 2 or 3 by touching the square field in the upper left corner of the screen, marked 2 and 3.

Touch the VCF touch button, to enter this page.

The VU-meter at the right of the screen, shows the filter output activity.

Cut: 0 to 511. Adjust the filter cutoff frequency.

Reso: 0 to 511. Adjusts the resonance of the filter.

LPF1: Switches filter output 1 between 24dB and 12dB steepness.

18dB: Switches the 18dB lowpass block on filter output 2 on or off. The phase of this is inverted compared to the phase of the 12 and 24 dB outputs on output 1, so when mixing with these, different filter modes can be obtained.

6dB: Switches the 6dB lowpass block on filter output 2 on or off. The phase of this is inverted compared to the phase of the 12 and 24 dB outputs on output 1, so when mixing with these, different filter modes can be obtained.

Out1/2: Mixes between the filter outputs 1 (12dB/24dB) and 2 (Inversed 6dB/18dB).

Filterboard 6 (SP Filter):

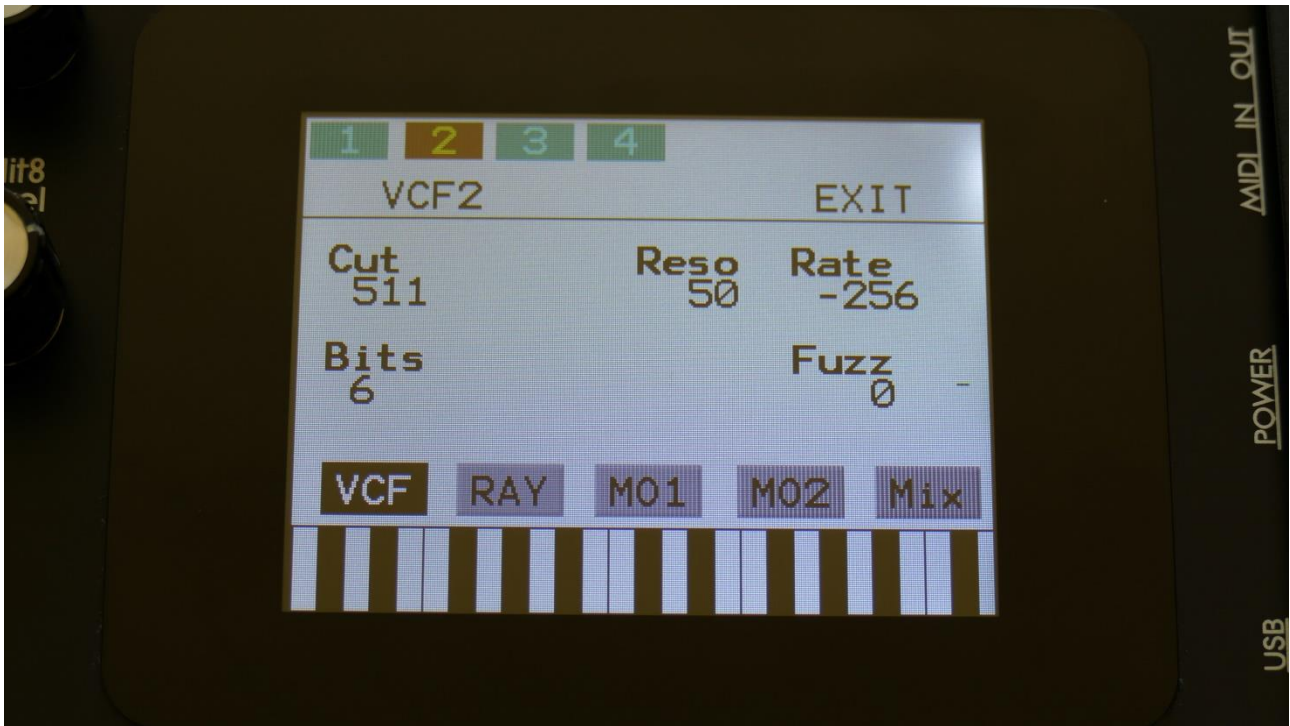

Select filter chain 2 or 3 by touching the square field in the upper left corner of the screen, marked 2 and 3.

Touch the VCF touch button, to enter this page.

The VU-meter at the right of the screen, shows the filter output activity.

Cut: 0 to 511. Adjust the filter cutoff frequency.

Reso: 0 to 511. Adjusts the resonance of the filter.

Rate: Sample Rate. 0 to 60 KHz.

Bits: Bit depth. 12 or 6 bit.

Fuzz: Adds an analog Fuzz effect, when turned up.

Filterboard 7 (Tubaz):

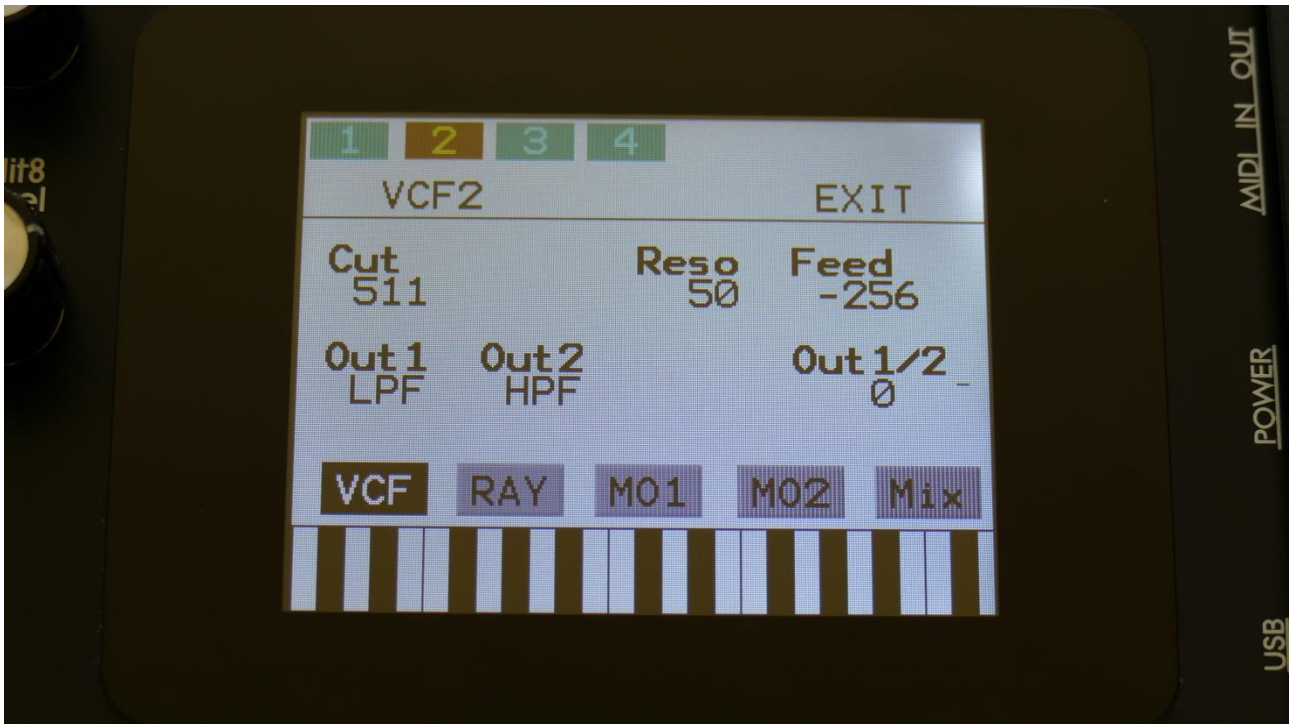

Select filter chain 2 or 3 by touching the square field in the upper left corner of the screen, marked 2 and 3.

Touch the VCF touch button, to enter this page.

The VU-meter at the right of the screen, shows the filter output activity.

Cut: 0 to 511. Adjust the filter cutoff frequency.

Reso: 0 to 511. Adjusts the resonance of the filter.

Cut3/Feed: -256 to +255. Negative feedback.

Out1: BPF or LPF select.

Out2: Always HPF.

Out1/2: Mix between filter output 1 (BPF/LPF) and filter output 2 (HPF).

Filterboard 8 (SSI-Spaze):

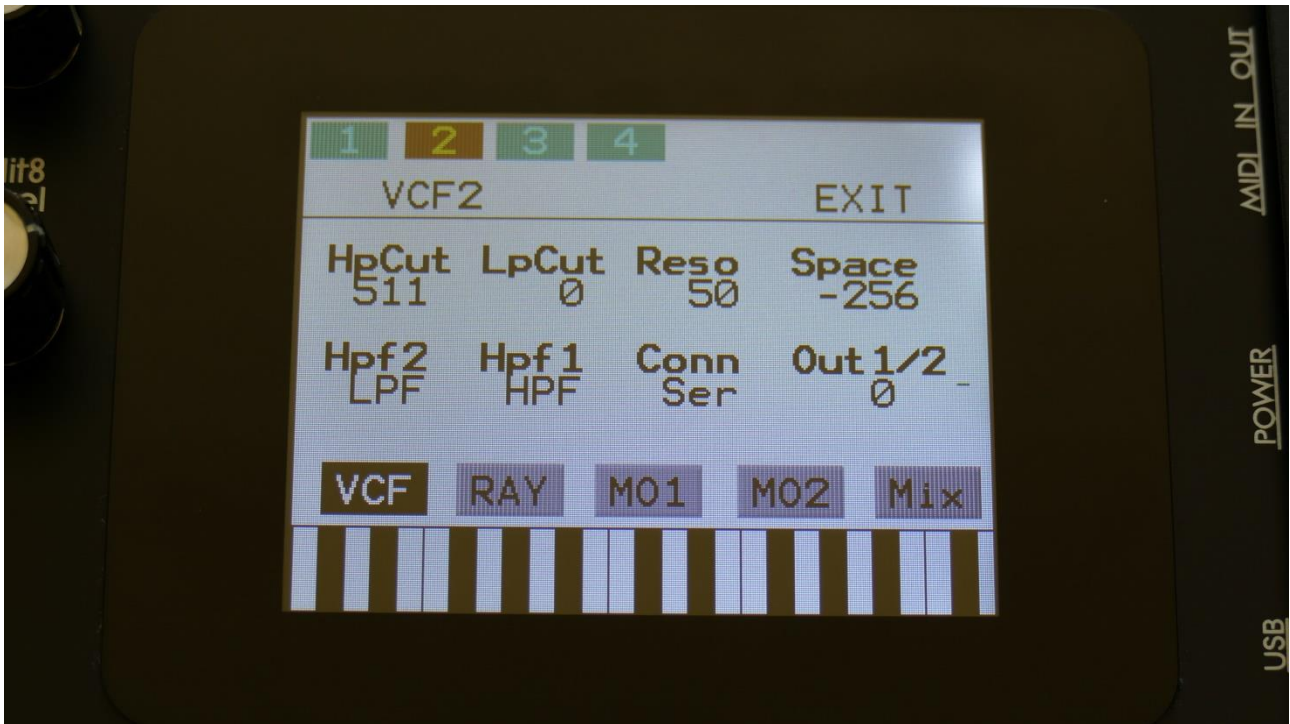

Select filter chain 2 or 3 by touching the square field in the upper left corner of the screen, marked 2 and 3.

Touch the VCF touch button, to enter this page.

The VU-meter at the right of the screen, shows the filter output activity.

HpCut: HPF/LPF 1 and 2 filter cutoff frequency. Space between the 2 filters can be adjusted with Space.

LpCut: LPF 1 and 2 filter cutoff frequency. Space between the 2 filters can be adjusted with Space.

Reso: Filter resonance of all 4 filters.

Space: Space between the cutoff frequencies of the two filter chains.

HPF2: HPF2 filter mode HPF or LPF.

HPF1: HPF1 filter mode HPF or LPF.

Conn: Connection of the 2 filter chains. Ser (serial) or Par (parallel).

Out1/2: Mix between filter output 1 (HPF/LPF + LPF chain 1) and filter output 2 (HPF/LPF + LPF chain 2).

SPAZEboard 2, VCF2 and 3 G-Ray

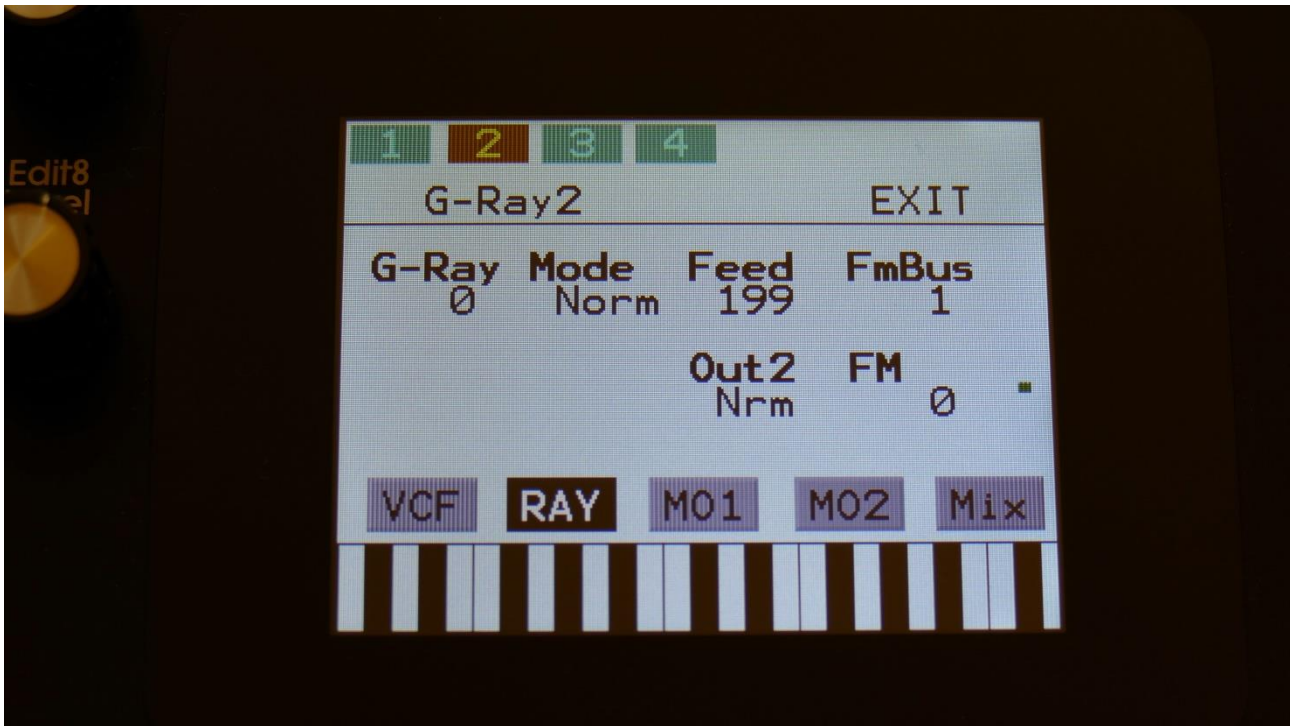

Touch the RAY touch button, to enter this page.

The VU-meter at the right of the screen, shows the filter output activity.

G-Ray: 0 to 3. Adjusts the amount of g-RAY intermodulation. 0: no g-RAY, 3: max g-RAY.

Mode: G-Ray mode.

-**Norm:** Normal 1:1 feedback.

-**Neg:** 1:1 feedback with the signal inverted (a 180 degree phase shift)

-**Ultr:** Boosted feedback.

-**Uneg:** Boosted feedback with the signal inverted (a 180 degree phase shift)

Feed: 0 to 511. G-Ray feedback level.

FM: 0 to 511. The amount of frequency modulation (audio range), that are applied to all of the filter cutoff frequencies, from the audio Bus selected by the FmBus parameter.

FmBus: 1 to 8. The audio bus, that will apply the audio signal for FM.

Out2: 0 to 511. Selects whether output 2 of the analog filter should be normal (**Nrm**) or inverted (**Inv**). Sometimes it can get some great effects, when inverting output 2 of the filter, and adjust the Out1/2 mix.

SPACEboard 2, VCF2 and 3 Modulation 1

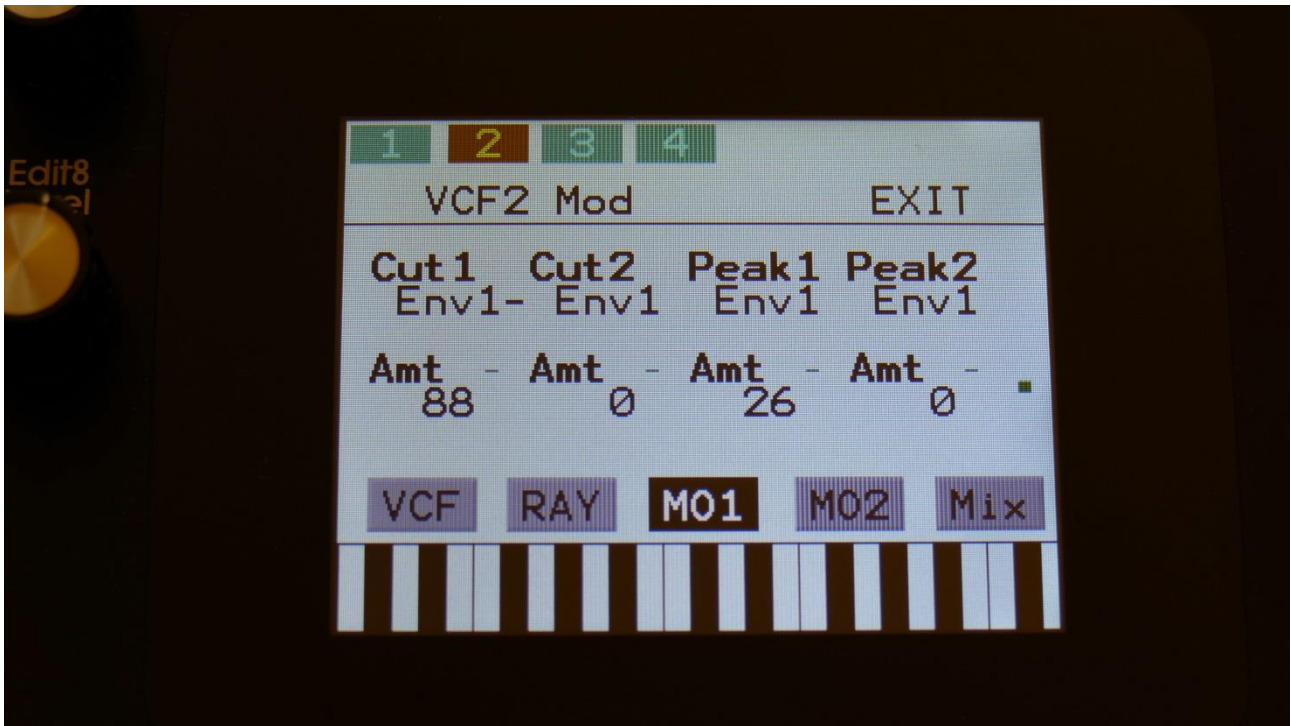

Touch the MO1 touch button, to enter this page.

The VU-meter at the right of the screen, shows the filter output activity.

For each parameter, that can be modulated, it is possible to select a modulation source, and to adjust the modulation amount. Only the positive modulation sources, can be selected by the Edit Knobs. To make a modulation source negative, touch the modulation source parameter. For a complete list of modulation sources, see the list in the start of this section.

The upper row of parameters selects the modulation sources, **The lower row of parameters** (Labelled Amt) adjusts the modulation amount in the range 0 to 511.

Cut1, Cut2: Will modulate the Cutoff Frequency.

Peak1, Peak2: Will modulate the Peaks parameter.

SPACEboard 2, VCF2 and 3 Modulation 2

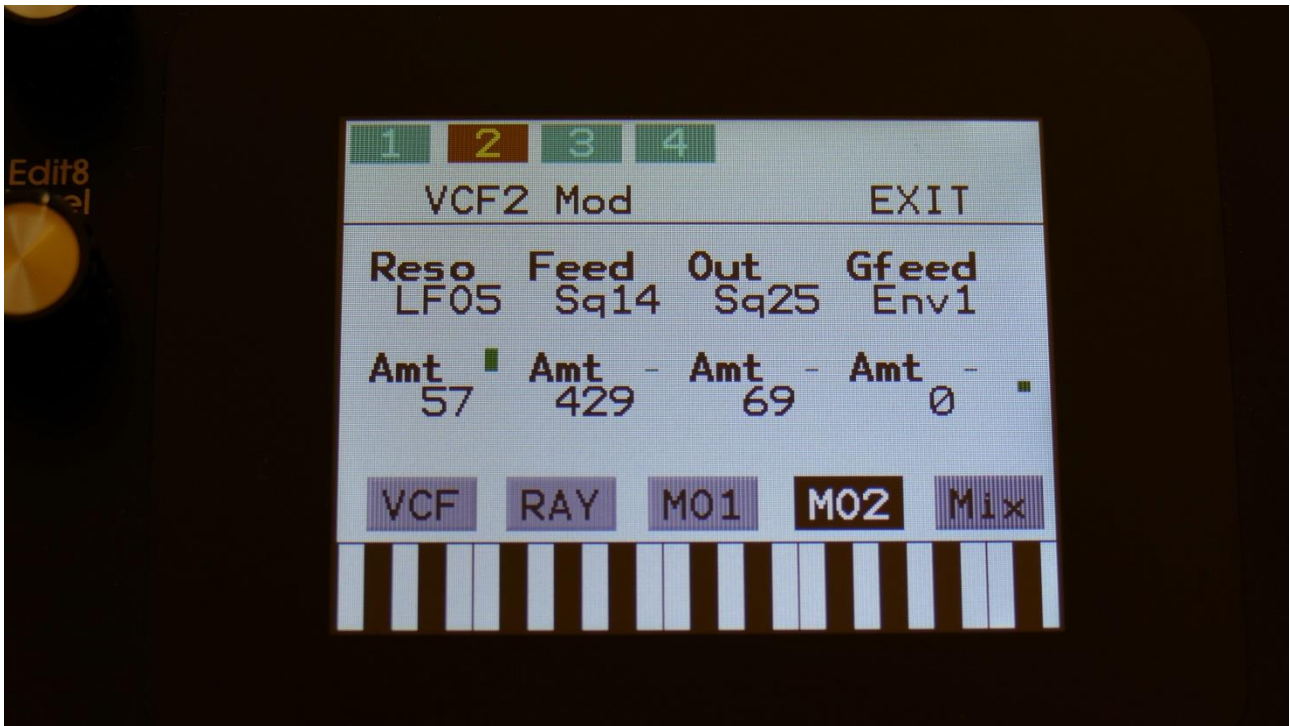

Touch the MO2 touch button, to enter this page.

The VU-meter at the right of the screen, shows the filter output activity.

For each parameter, that can be modulated, it is possible to select a modulation source, and to adjust the modulation amount. Only the positive modulation sources, can be selected by the Edit Knobs. To make a modulation source negative, touch the modulation source parameter. For a complete list of modulation sources, see the list in the start of this section.

The upper row of parameters selects the modulation sources, **The lower row of parameters** (Labelled Amt) adjusts the modulation amount in the range 0 to 511.

Reso: Will modulate the amount of resonance applied to all filters.

Feed: Will modulate the analog filter feedback/Cutoff frequency 3.

Out: Will modulate the Out1/2 mix parameter.

Gfeed: Will modulate the amount of G-Ray feedback applied.

SPACEboard 2, VCF2 and 3 Mix/Setup

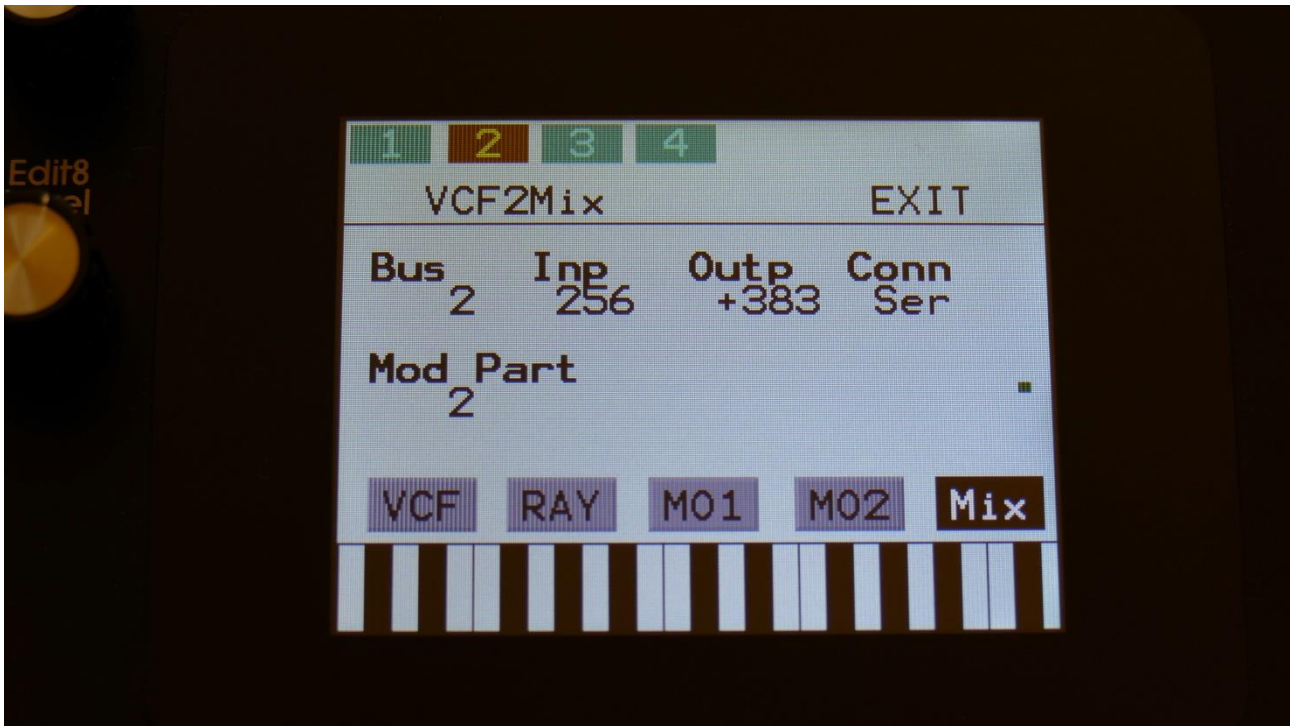

Touch the Mix touch button, to enter this page.

The VU-meter at the right of the screen, shows the filter output activity.

Bus: 1 to 8. The audio Bus, that the filter will be placed on.

Inp: 0 to 511. The audio input level for the filters.

Outp: -128 to +383. The output level of the filters.

Conn: Ser/Par. (Only on VCF2, 3 and 4). Places this filter in either serial or parallel to the lower numbered filter.

Mod Part: 1 to 16. The part from which, the filter modulation sources will be added.

Effects Processors

LD3 has 8 insert effect processors and 2 output effect processors, 10 effect processors in total. The insert effects can be placed on any audio bus, for processing the parts and input assigned to the bus. The audio busses can be sent to the output effects. The output effects outputs to the main L and R outputs.

Selecting the effect processors

From the synth parts main page, touch EFX to enter an effect page. OR: Push and release the Func/Mute button, so that it lights up, and push step button 11/EFX 1 time.

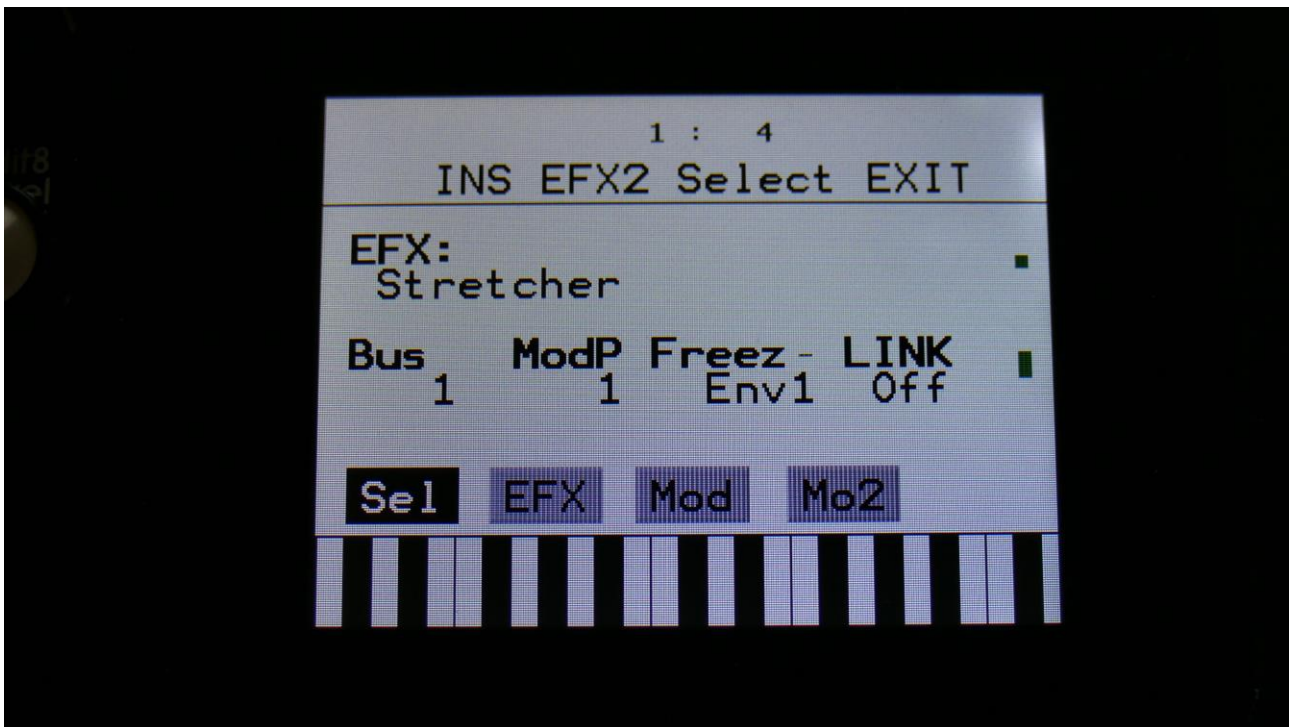

To select the different effect processors, you will need to push and hold the Steps/Part button, while pushing step button 1 to 10.

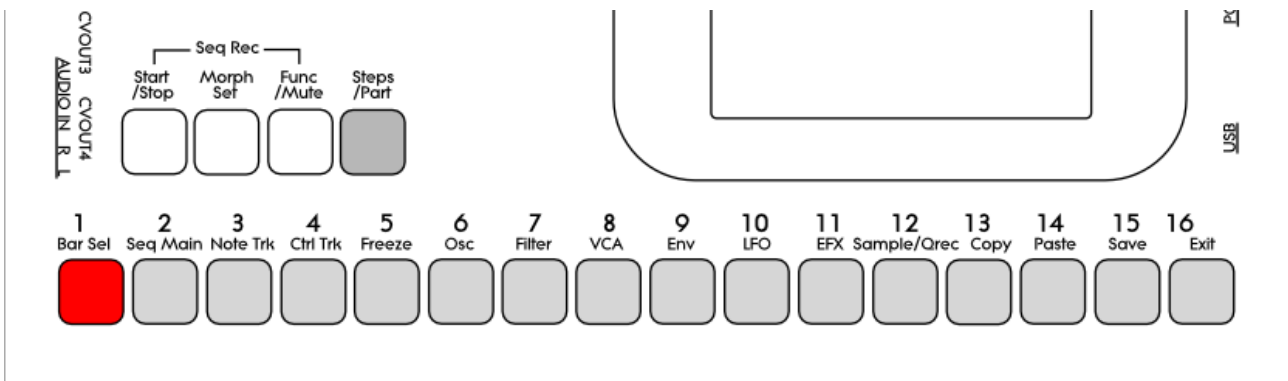

Part 1 is insert effect 1

Part 2 is insert effect 2

Part 3 is insert effect 3

-

Part 8 is insert effect 8

Part 9 is output effect 1

Part 10 is output effect 2

The effects are selected separately from the parts. So Output Effect 2 can for instance be selected, at the same time as part 4 is selected.

Insert Effects 1 to 8

LD3 has 8 insert effects. Each of these can be placed on any of the 8 audio busses, to process the synth/sampler parts and audio inputs, that are assigned to the same bus.

All effects has a bypass switch, Freeze modulation, and a mix parameter.

2 effects can be linked together, for true stereo processing. When an effect is linked to another effect, any parameter tweaks on the source effect, will be mirrored to the linked effect. When switching link off, the parameter settings of the linked effect is kept, so it is possible to make some adjustments, if you don't want the 2 effects to be exactly alike.

List of Insert Effects

Chorus – Gotharman's special chorus with an added Deep parameter, that adds space to the chorus.

Distortion – 4 types: Valve, Sine, Fuzz, Xdis.

Bit Crush – Lowers the sample rate and the bit resolution of the sound, to obtain lo-fi effects.

Pitch Shifter – Shift the pitch of the sound up to 4 octaves up or down, without changing the time resolution or “tempo” of the sound. Adjustable sense.

Resonator – Simulates the resonances that comes, if a sound goes through a small box. LD3's resonators are synthetic, with more focus on making sounds, than on simulating actual boxes.

Stretcher – Tries to time stretch the input signal, while at the same time keeping up with it. Impossible? -Yes, indeed :-)

FM – Adds self-FM to the input signal in +/- 1 octave, +/- 2 octaves or +/- 4 octaves ranges.

Glitch Shifter – Imperfect pitch shifter.

Glitch Shifter 2 – Imperfect pitch shifter with a slightly different sound than the first one.

Glitch Shifter 3 – Imperfect pitch shifter with a slightly different sound than the first two.

Pitch Shaper – 1 input version of Gotharman's special Pitch Shaper, that forces an audio signal to play back at a specific pitch, determined by an adjustable frequency.

FAT - Adds up to 3 layers of the sound to itself, and it is possible to adjust the phase of these, and to select whether the effect sound should be boosted or just layered.

Filter - This is exactly the same filters, as can be found in the synth parts. They were added to the insert effects section, in order to make it possible to filter external signals, to build an LD2 style filterbank, using multiples of these, and because sometimes it is handy to filter some parts of the other effects or the analog filters out.

Filters 2 - A different set of digital filters, that is emphasized in the bottom bass area, and has a pretty uncontrollable resonance.

Compressor - Damps audio signals that are above a settable level, in order to make the signal less dynamic, and easier to record. This is not the same effect as the compressor in LD2. The LD2 compressor has been renamed “Expandor”.

Expandor - Gains audio signals that are above a settable level, in order to add more kick to sounds. This is the effect, that was named “Compressor” on the LD2.

PitchShaper 2 - This is a dual input PitchShaper. The pitch of the signal applied to input 1, is pitch matched to the signal applied to input 2. When changing the pitch of the pitch matched signal, the waveform on the effect output will change, still matched to the pitch of input 2.

It is also possible for the signal applied to input 1, to affect the output pitch, by turning the Vari parameter up.

The audio bus that this effect is placed on, applies the signal to be re-pitched. The audio bus numbered above the bus, that the effect is placed on, applies the signal that the first signal should be pitch matched to.

Delay 1 – Delay with time and feedback controls, plus Gotharman's Deep and Xfade controls. Deep adds space to the delay. The Xfade control on this delay, creates valleys between the delay taps. The more it is turned up, the more time the valleys takes up.

Roto Delay – This is a 2 tap delay, that is constantly crossfading between the 2 taps. When the Xfade control is turned down, the crossfading is rough, the more it is turned up, the more smooth the crossfading gets. Other controls are the same as the first delay.

Bright Delay – First delay, but with a brighter sound, created by a resonator.

Bright Roto Delay – Roto delay, but with a brighter sound, created by a resonator.

Variator – Creates new variations of the input signal. Both pitch and rhythmic variations.

Time Stretch - This effect is able to change the length of the input signal, almost without changing the pitch. Old fashioned time stretch done in realtime, that can be applied even to live input signals! It is also possible to change the pitch if desired, and it is possible to trigger this effect, for bigger precision.

Sample Pitch - Changes the pitch of a sampling, without changing the length, using granular technology. It is possible to set the size of each pitch grain, to generate great granular effects. This effect has to be triggered from any of the parts, in order to function properly. It will work on external signals, but it still needs to be triggered by a part.

Insert effects Select page

From the synth parts main page, touch EFX to enter the effect pages. OR: Push and release the Func/Mute button, so that it lights up, and push step button 11/EFX 1 time.

Push and hold the Steps/Part button, while pushing step button 1 to 10.

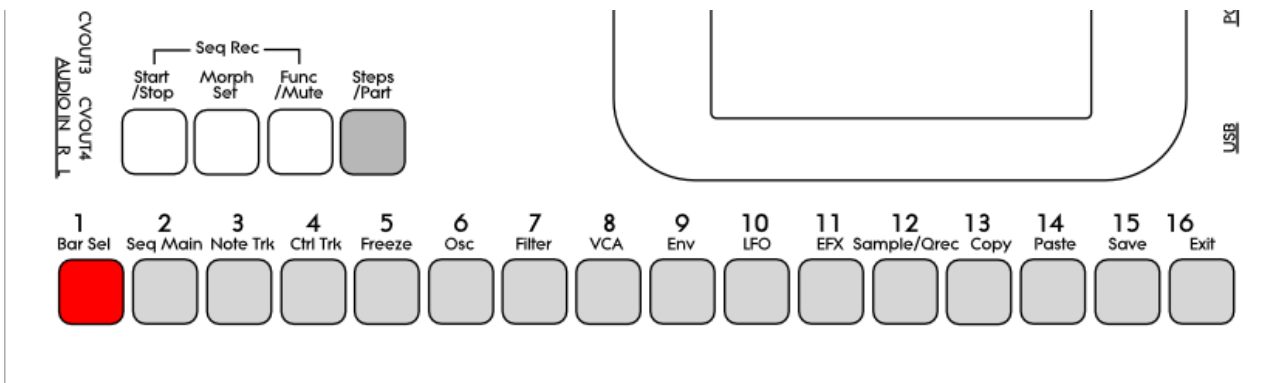

Part 1 is insert effect 1

Part 2 is insert effect 2

Part 3 is insert effect 3

-

Part 8 is insert effect 8

Part 9 is output effect 1

Part 10 is output effect 2

The effects are selected separately from the parts. So Output Effect 2 can for instance be selected, at the same time as part 4 is selected.

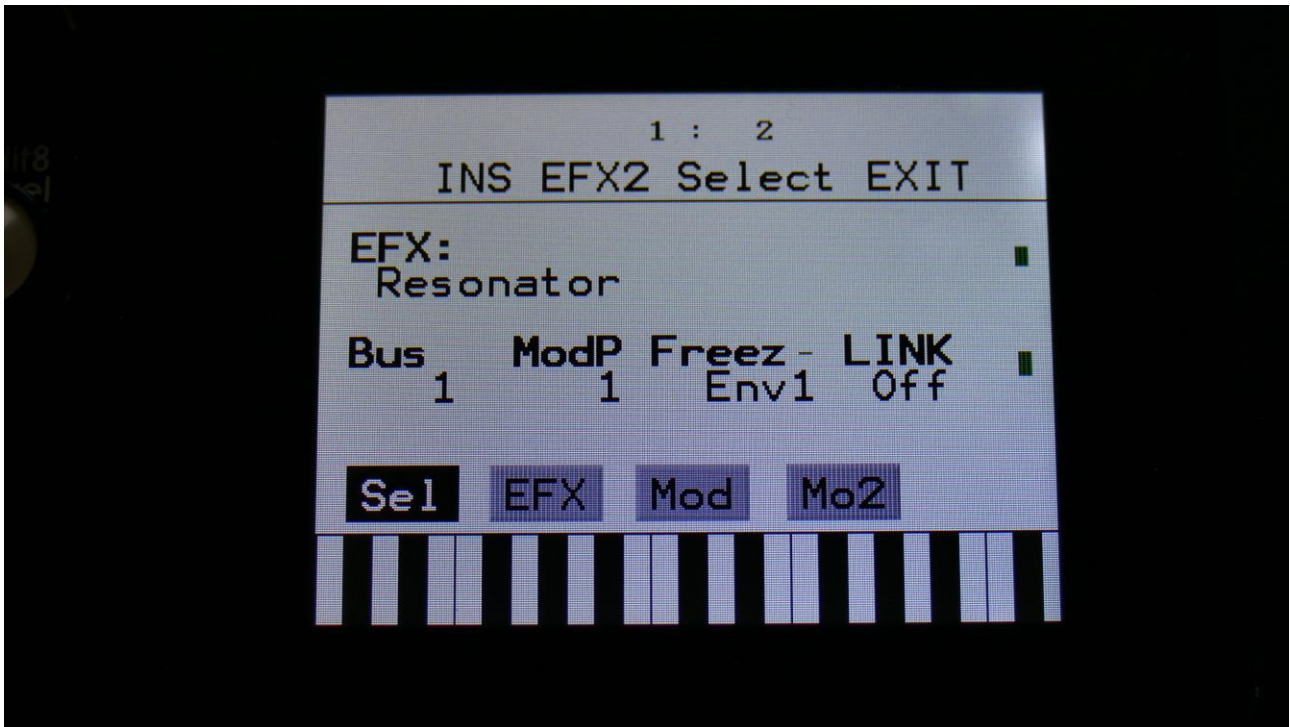

Touch the SEL touch button, to enter the effect select page.

The 2 VU-meters at the right of the screen, shows the Effect input and output activity.

EFX: Selects the effect. Please see the List Of Insert Effects in the beginning of this section.

Bus: 1 to 8. Places the insert effect on any of the 8 audio busses.

ModP: 1 to 16. Modulation source part. Selects the synth part, from which the insert effect will get the modulation sources, selected on the modulation page.

Freez: Freeze modulation. Can be set to off, Freeze button (Buton) or to any modulation source. When set to any other value than off, the effect will freeze, when the modulation source are in its upper range. When an effect freezes, it no longer samples its audio input signal, but only outputs whatever it already holds in its audio buffer.

Link: Insert effects 2, 4, 6 and 8 can be linked to effects 1, 3, 5 and 7, for true stereo effects processing.

Insert Effects Parameters

Mix Modulation and Backwards Delay



The Effect dry/wet mix can be modulated on all effects.

Touch the MO2 touch button, to access this page.

The 2 VU-meters at the right of the screen, shows the Effect input and output. The small VU-meters next to the parameters, shows the activity of the selected modulation sources.

For each parameter, that can be modulated, it is possible to select a modulation source, and to adjust the modulation amount. Only the positive modulation sources, can be selected by the Edit Knobs. To make a modulation source negative, touch the modulation source parameter. For a complete list of modulation sources, see the list in the start of this section.

The upper row of parameters selects the modulation sources, **the lower row of parameters** (Labelled Amt) adjusts the modulation amount in the range 0 to 511.

The parameters on this page:

Mix: Modulates the effect dry/wet mix.

Bkwd: This is only visible, when a delay effect is selected. Turning this on, will make the delay effect play back backwards.

Chorus



Touch the EFX touch button, to access this page.

The 2 VU-meters at the right of the screen, shows the Effect input and output.

Efx: Off, on. When the effect is off, it is bypassed.

Mix: The mix between the un-effected signal on the effect input, and the effected signal on the effect output.

Feed: Chorus feedback amount.

Time: Chorus Time. This should be modulated by an LFO, to get the traditional chorus effect.

Deep: Adjusts how deep the chorus box should be. A Gotharman special.

Chorus Modulation

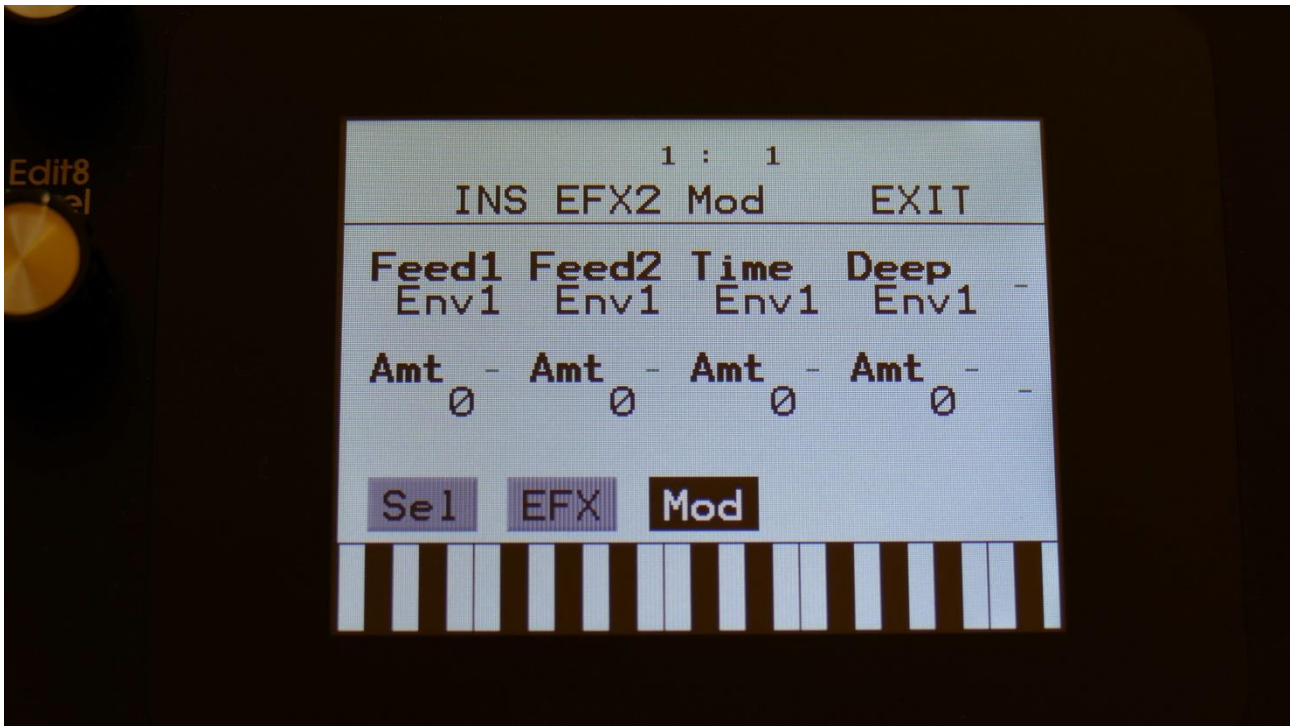

Touch the Mod touch button, to access this page.

The 2 VU-meters at the right of the screen, shows the Effect input and output. The small VU-meters next to the parameters, shows the activity of the selected modulation sources.

For each parameter, that can be modulated, it is possible to select a modulation source, and to adjust the modulation amount. Only the positive modulation sources, can be selected by the Edit Knobs. To make a modulation source negative, touch the modulation source parameter. For a complete list of modulation sources, see the list in the start of this section.

The upper row of parameters selects the modulation sources, **the lower row of parameters** (Labelled Amt) adjusts the modulation amount in the range 0 to 511.

The parameters on this page:

Feed1 and Feed2: Modulates the chorus feedback.

Time: Modulates the time parameter.

Deep: Modulates the Deep parameter.

Distortion



Touch the EFX touch button, to access this page.

The 2 VU-meters at the right of the screen, shows the Effect input and output.

Efx: Off, on. When the effect is off, it is bypassed.

Mix: The mix between the un-effected signal on the effect input, and the effected signal on the effect output.

Drive: The higher the value, the more the sound will distort. If this is set to zero, no sound will pass through the distortion.

Offs: Distortion offset. The more this is turned up, the more asymmetric the distortion will get.

Type: Distortion type. Choices are:

- Valve:** A digital simulation of a classic valve distortion.
- Sine:** A noisy and warm sine shaping distortion.
- Fuzz:** Simulates a classic fuzz distortion.
- Xdis:** Complete destruction of the sound.

Distortion Modulation

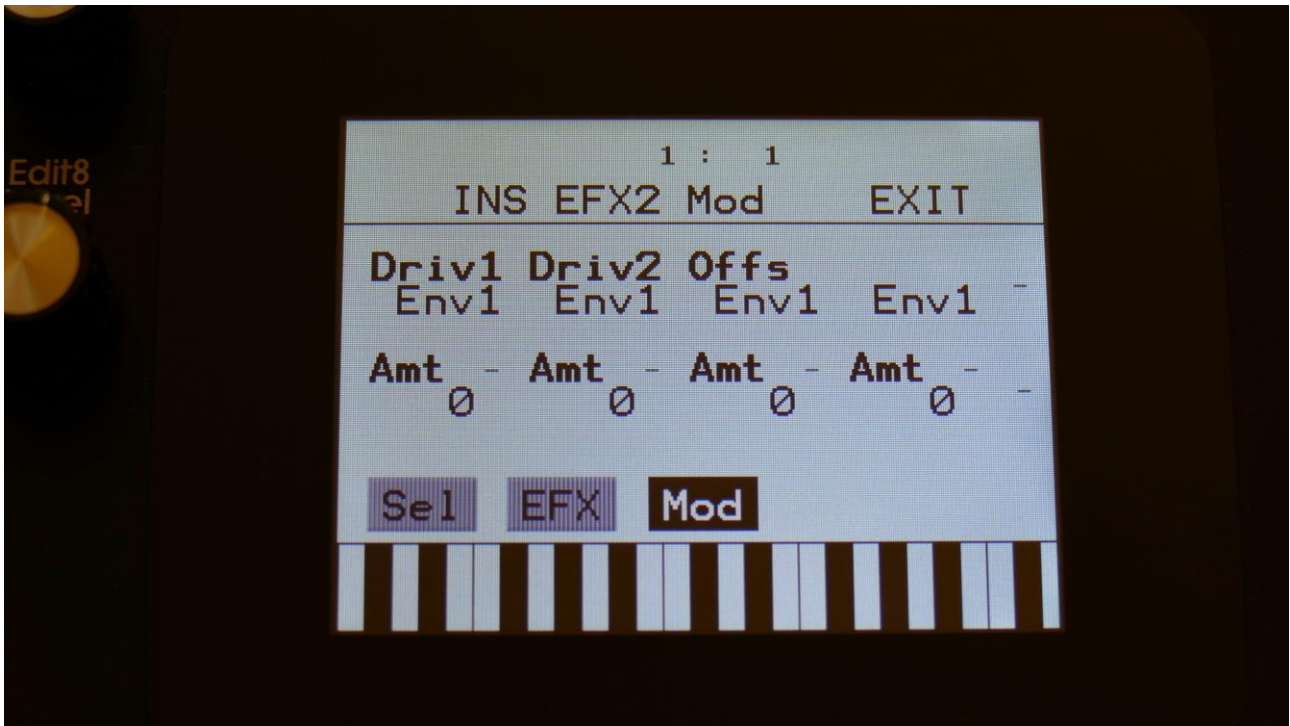

Touch the Mod touch button, to access this page.

The 2 VU-meters at the right of the screen, shows the Effect input and output. The small VU-meters next to the parameters, shows the activity of the selected modulation sources.

For each parameter, that can be modulated, it is possible to select a modulation source, and to adjust the modulation amount. Only the positive modulation sources, can be selected by the Edit Knobs. To make a modulation source negative, touch the modulation source parameter. For a complete list of modulation sources, see the list in the start of this section.

The upper row of parameters selects the modulation sources, **the lower row of parameters** (Labelled Amt) adjusts the modulation amount in the range 0 to 511.

The parameters on this page:

Driv1 and Driv2: Modulates the drive parameter.

Offs: Modulates the offset parameter.

Bit Crush

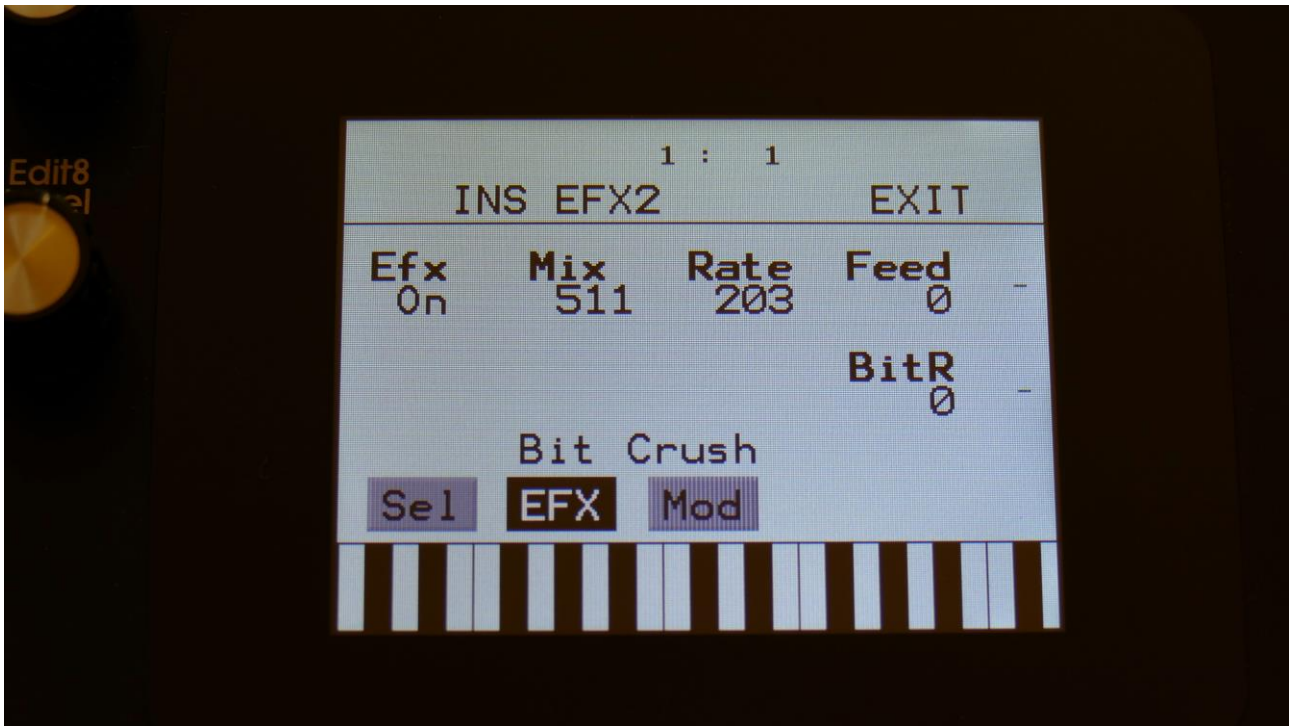

Touch the EFX touch button, to access this page.

The 2 VU-meters at the right of the screen, shows the Effect input and output.

Efx: Off, on. When the effect is off, it is bypassed.

Mix: The mix between the un-effected signal on the effect input, and the effected signal on the effect output.

Rate: Sample Rate Reduction. The more this is turned up, the lower the sample rate will be. From 44.1 KHz to 1 KHz.

Feed: Feedback. Turning this up will slightly overdrive the sound.

BitR: Bit Reduction. The more this is turned up, the lower the bit resolution will get. When it is turned fully down, resolution is 16 bit, when turned fully up, it is 1 bit.

Bit Crush Modulation

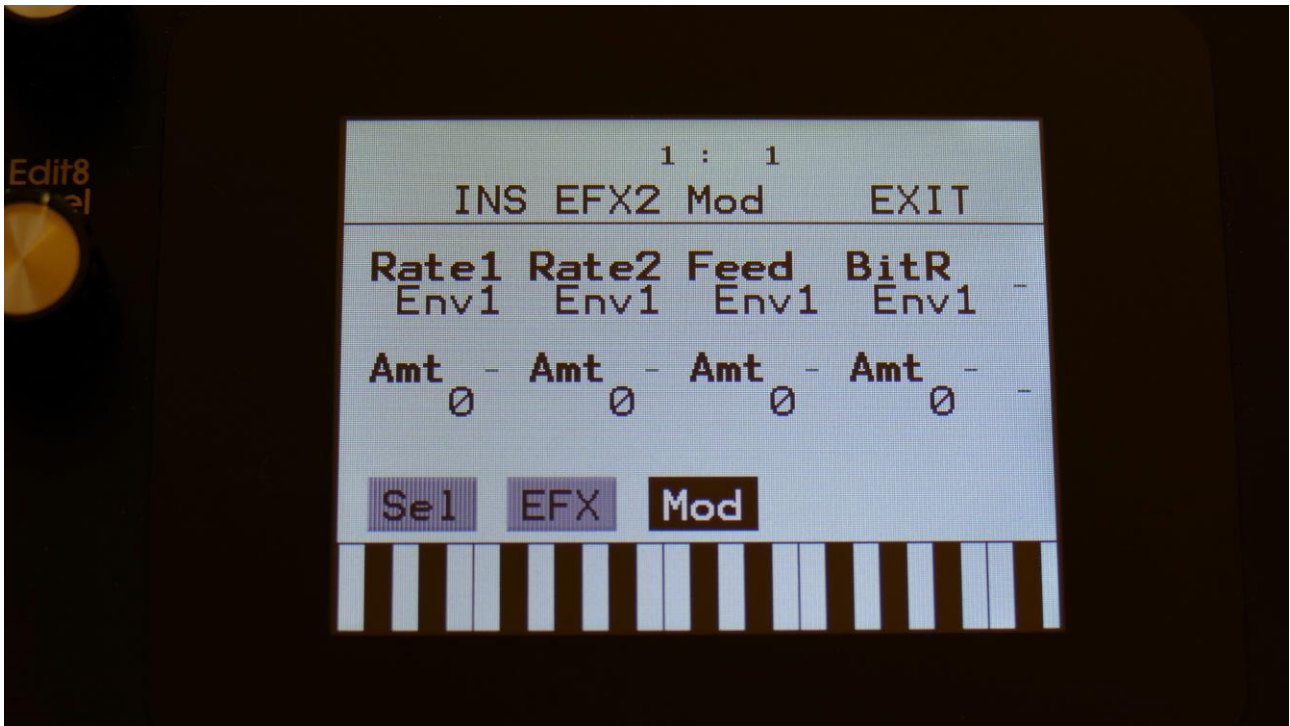

Touch the Mod touch button, to access this page.

The 2 VU-meters at the right of the screen, shows the Effect input and output. The small VU-meters next to the parameters, shows the activity of the selected modulation sources.

For each parameter, that can be modulated, it is possible to select a modulation source, and to adjust the modulation amount. Only the positive modulation sources, can be selected by the Edit Knobs. To make a modulation source negative, touch the modulation source parameter. For a complete list of modulation sources, see the list in the start of this section.

The upper row of parameters selects the modulation sources, **the lower row of parameters** (Labelled Amt) adjusts the modulation amount in the range 0 to 511.

The parameters on this page:

Rate1 and Rate2: Modulates the sample rate parameter.

Feed: Modulates the feedback parameter.

BitR: Modulates the bit reduction parameter.

Pitch Shifter

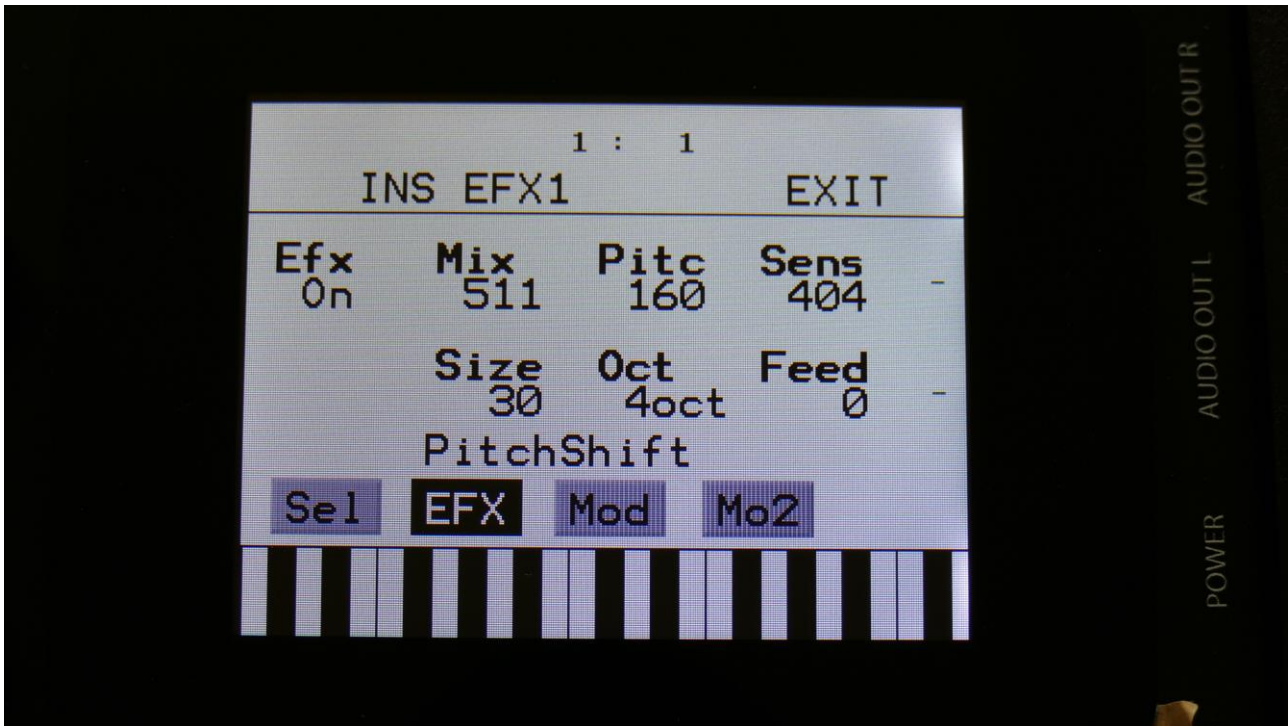

Touch the EFX touch button, to access this page.

The 2 VU-meters at the right of the screen, shows the Effect input and output.

Efx: Off, on. When the effect is off, it is bypassed.

Mix: The mix between the un-effected signal on the effect input, and the effected signal on the effect output.

Pitc: Smoothly pitches the sound from up to 4 octaves below the original pitch, to 4 octaves above.

Sense: Pitch detection sense. On a pure waveform, turn this fully down to make sure, that it detects all the waves of it, and pitch shifts correctly. On more complex sounds, turn this up until the desired effect are obtained. At higher settings, only portions of the sound will be pitch shifted, and when it doesn't detect any pitch, it will repeat the portion it detected, making the sound "granulate".

Size: 1 to 64. This sets the size of the buffer, used for the pitch shifting effect. When pitch shifting more complex sounds, it might make the pitch shifting more precise, when turning this parameter up a bit.

Oct: The octave range of the pitch shifter. From +/- 1 to +/- 4 octaves.

Feed: Pitch shifter feedback. Adjusts the portion of the output signal, that is fed back to the input.

Pitch Shifter Modulation

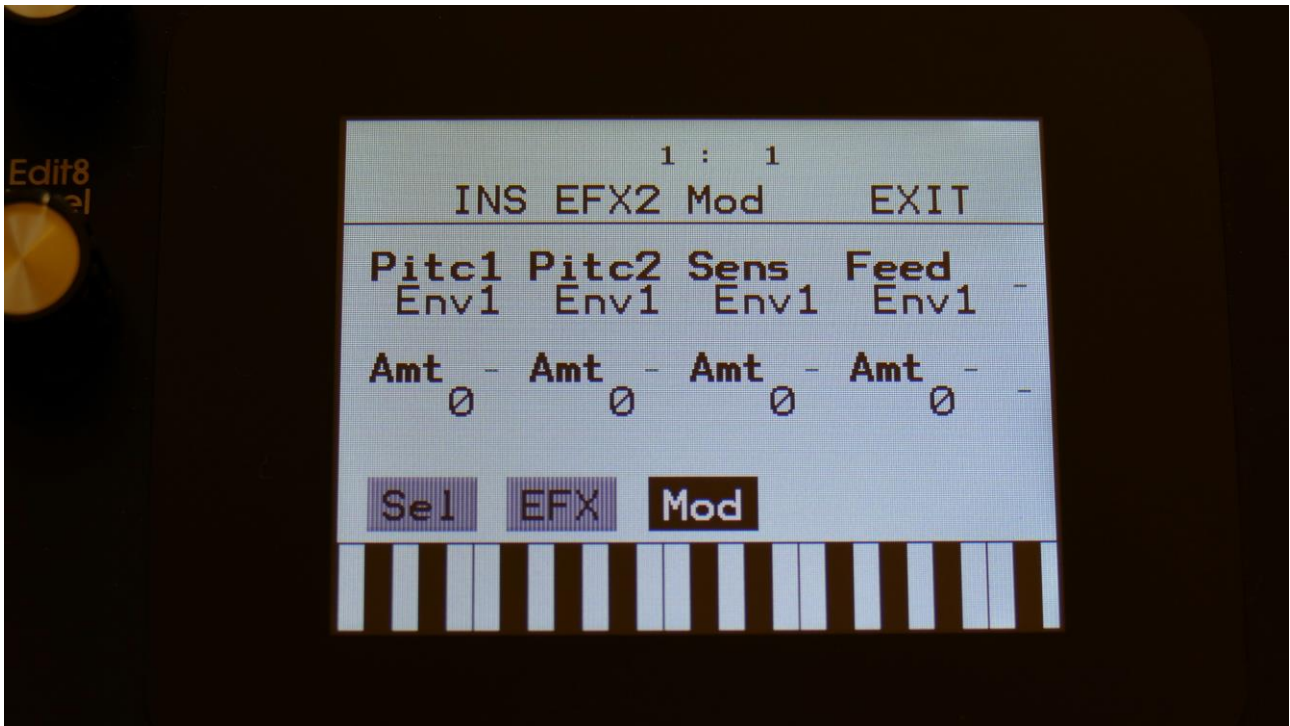

Touch the Mod touch button, to access this page.

The 2 VU-meters at the right of the screen, shows the Effect input and output. The small VU-meters next to the parameters, shows the activity of the selected modulation sources.

For each parameter, that can be modulated, it is possible to select a modulation source, and to adjust the modulation amount. Only the positive modulation sources, can be selected by the Edit Knobs. To make a modulation source negative, touch the modulation source parameter. For a complete list of modulation sources, see the list in the start of this section.

The upper row of parameters selects the modulation sources, **the lower row of parameters** (Labelled Amt) adjusts the modulation amount in the range 0 to 511.

The parameters on this page:

Pitc1 and Pitc2: Modulates the pitch shift parameter.

Sens: Modulates the Sense parameter.

Feed: Modulates the Feed parameter.

Resonator



Touch the EFX touch button, to access this page.

The 2 VU-meters at the right of the screen, shows the Effect input and output.

Efx: Off, on. When the effect is off, it is bypassed.

Mix: The mix between the un-effected signal on the effect input, and the effected signal on the effect output.

Feed: Resonator feedback. The more this is turned up, the more it will resonate.

Size: The size of the resonator box. Different sizes will give different resonance frequencies.

Resonator Modulation

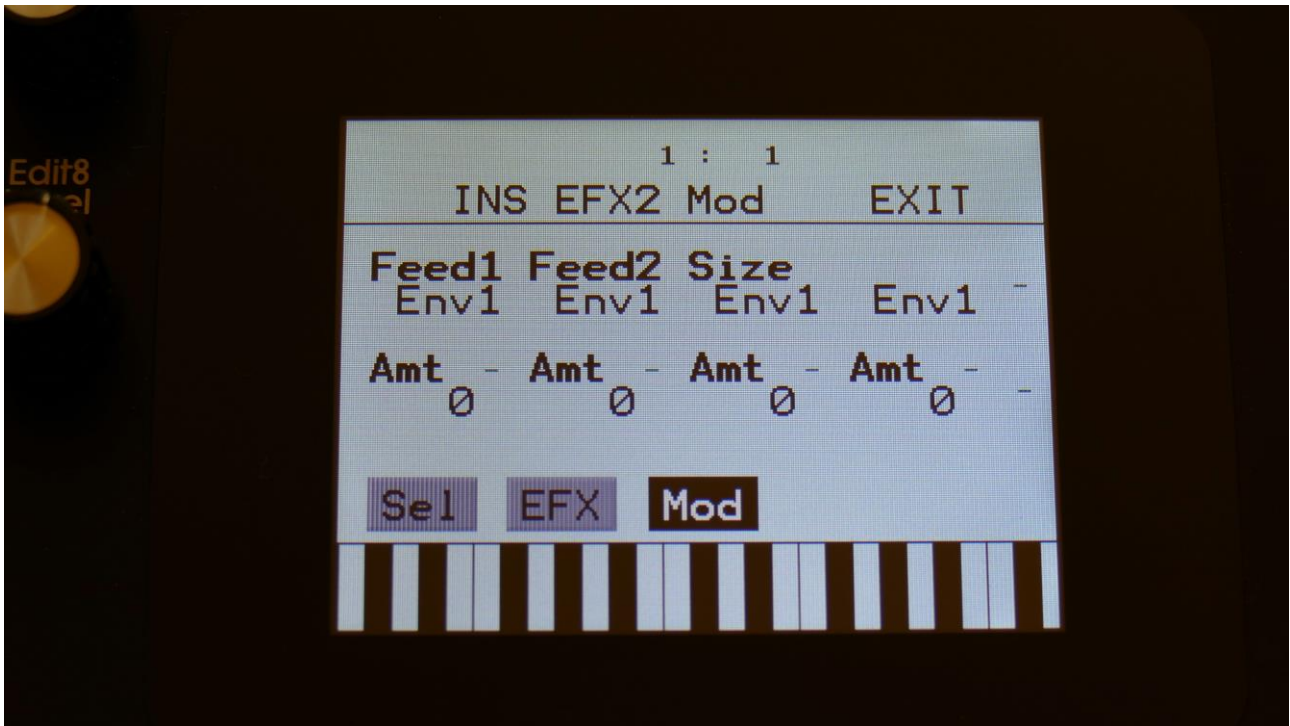

Touch the Mod touch button, to access this page.

The 2 VU-meters at the right of the screen, shows the Effect input and output. The small VU-meters next to the parameters, shows the activity of the selected modulation sources.

For each parameter, that can be modulated, it is possible to select a modulation source, and to adjust the modulation amount. Only the positive modulation sources, can be selected by the Edit Knobs. To make a modulation source negative, touch the modulation source parameter. For a complete list of modulation sources, see the list in the start of this section.

The upper row of parameters selects the modulation sources, **the lower row of parameters** (Labelled Amt) adjusts the modulation amount in the range 0 to 511.

The parameters on this page:

Feed1 and Feed2: Modulates the feed parameter.

Size: Modulates the Size parameter.

Stretcher

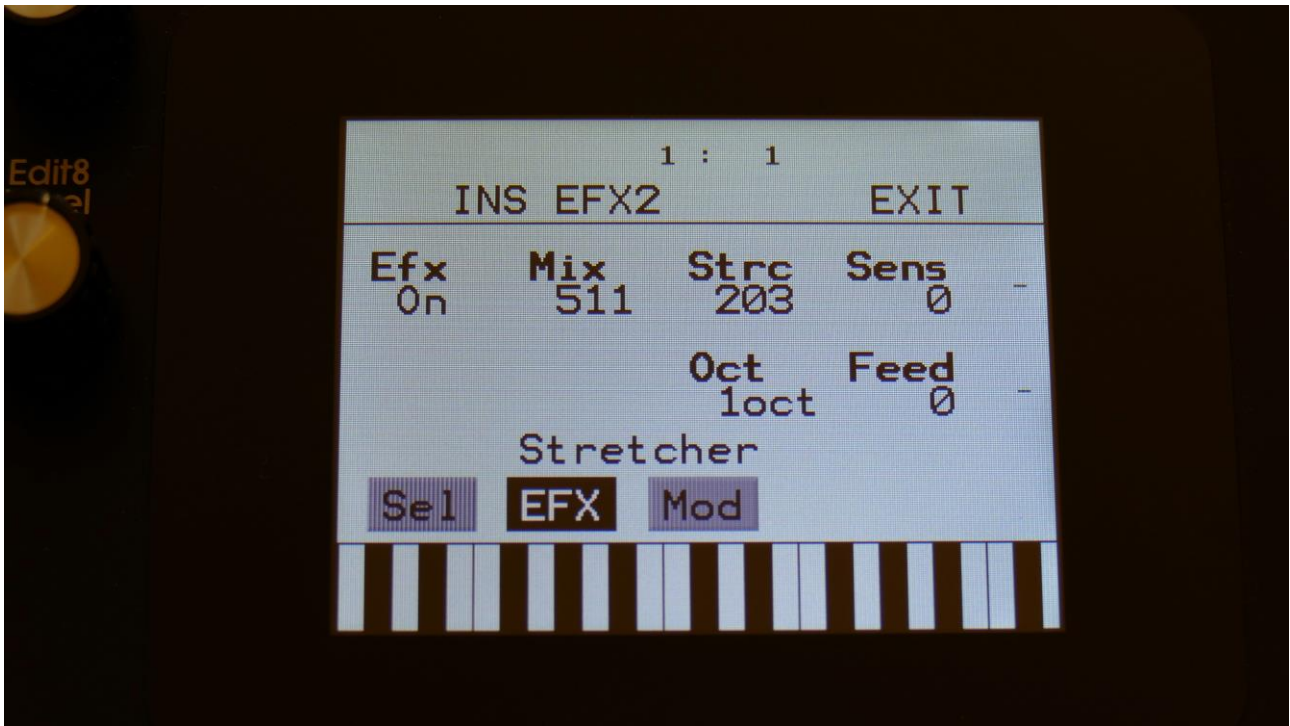

Touch the EFX touch button, to access this page.

The 2 VU-meters at the right of the screen, shows the Effect input and output.

Efx: Off, on. When the effect is off, it is bypassed.

Mix: The mix between the un-effected signal on the effect input, and the effected signal on the effect output.

Strc: The degree of time stretch.

Sens: Stretch detection sense. At lower settings the sound will “wobble”, at higher settings it will “granulate”. Adjust this to obtain different effects.

Oct: The octave range of the stretch effect. From +/- 1 to +/- 4 octaves.

Feed: Stretcher feedback. Adjusts the portion of the output signal, that is fed back to the input.

Stretcher Modulation

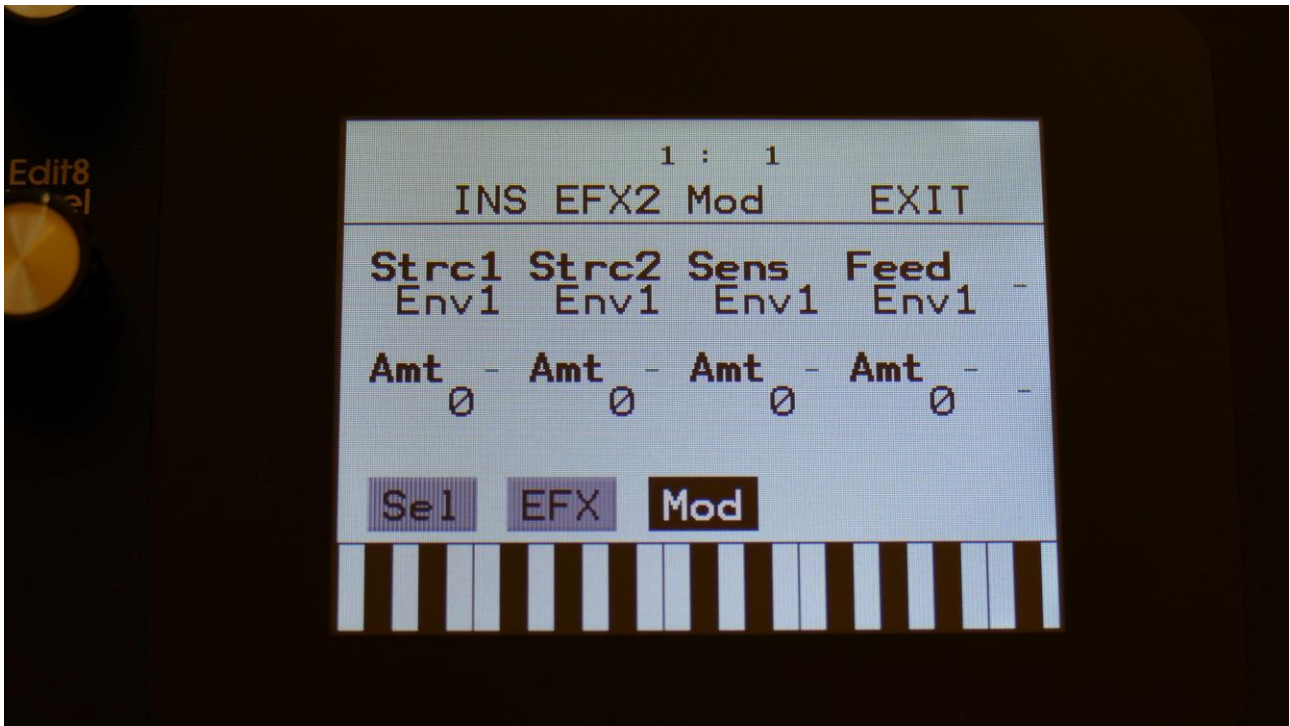

Touch the Mod touch button, to access this page.

The 2 VU-meters at the right of the screen, shows the Effect input and output. The small VU-meters next to the parameters, shows the activity of the selected modulation sources.

For each parameter, that can be modulated, it is possible to select a modulation source, and to adjust the modulation amount. Only the positive modulation sources, can be selected by the Edit Knobs. To make a modulation source negative, touch the modulation source parameter. For a complete list of modulation sources, see the list in the start of this section.

The upper row of parameters selects the modulation sources, **the lower row of parameters** (Labelled Amt) adjusts the modulation amount in the range 0 to 511.

The parameters on this page:

Strc1 and Strc2: Modulates the stretch parameter.

Sens: Modulates the sense parameter.

Feed: Modulates the feed parameter.

FM



Touch the EFX touch button, to access this page.

The 2 VU-meters at the right of the screen, shows the Effect input and output.

Efx: Off, on. When the effect is off, it is bypassed.

Mix: The mix between the un-effected signal on the effect input, and the effected signal on the effect output.

FM: The amount of self-FM from 0 to up to +/- 4 octaves.

Sense: FM pitch detection sense. On a pure waveform, turn this fully down to make sure, that it detects all the waves of it, and pitch shifts correctly. On more complex sounds, turn this up until the desired effect are obtained. At higher settings, only portions of the sound will be pitch shifted, and when it doesn't detect any pitch, it will repeat the portion it detected, making the sound "granulate".

Oct: The octave range of the FM effect. From +/- 1 to +/- 4 octaves.

Feed: FM feedback. Adjusts the portion of the output signal, that is fed back to the input.

FM Modulation

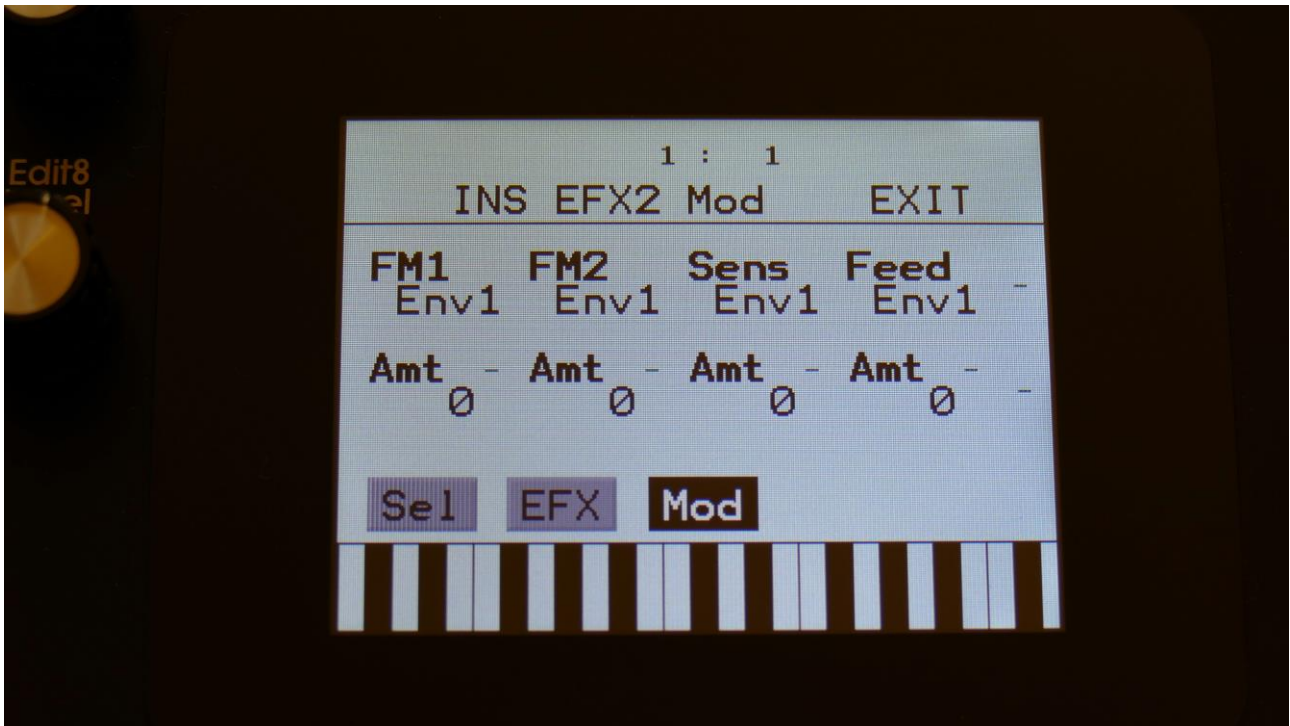

Touch the Mod touch button, to access this page.

The 2 VU-meters at the right of the screen, shows the Effect input and output. The small VU-meters next to the parameters, shows the activity of the selected modulation sources.

For each parameter, that can be modulated, it is possible to select a modulation source, and to adjust the modulation amount. Only the positive modulation sources, can be selected by the Edit Knobs. To make a modulation source negative, touch the modulation source parameter. For a complete list of modulation sources, see the list in the start of this section.

The upper row of parameters selects the modulation sources, **the lower row of parameters** (Labelled Amt) adjusts the modulation amount in the range 0 to 511.

The parameters on this page:

FM1 and FM2: Modulates the FM parameter.

Sens: Modulates the sense parameter.

Feed: Modulates the feed parameter.

Glitch Shifter, Glitch Shifter 2, Glitch Shifter 3



Touch the EFX touch button, to access this page.

The 2 VU-meters at the right of the screen, shows the Effect input and output.

Efx: Off, on. When the effect is off, it is bypassed.

Mix: The mix between the un-effected signal on the effect input, and the effected signal on the effect output.

Pitc: Glitchy pitches the sound from up to 4 octaves below the original pitch, to 4 octaves above.

Sense: Pitch detection sense. On a pure waveform, turn this fully down to make sure, that it detects all the waves of it, and pitch shifts correctly. On more complex sounds, turn this up until the desired effect are obtained. At higher settings, only portions of the sound will be pitch shifted, and when it doesn't detect any pitch, it will repeat the portion it detected, making the sound "granulate".

Oct: The octave range of the glitch shifter. From +/- 1 to +/- 4 octaves.

Feed: Glitch shifter feedback. Adjusts the portion of the output signal, that is fed back to the input.

Glitch Shifter, Glitch Shifter 2, Glitch Shifter 3 Modulation

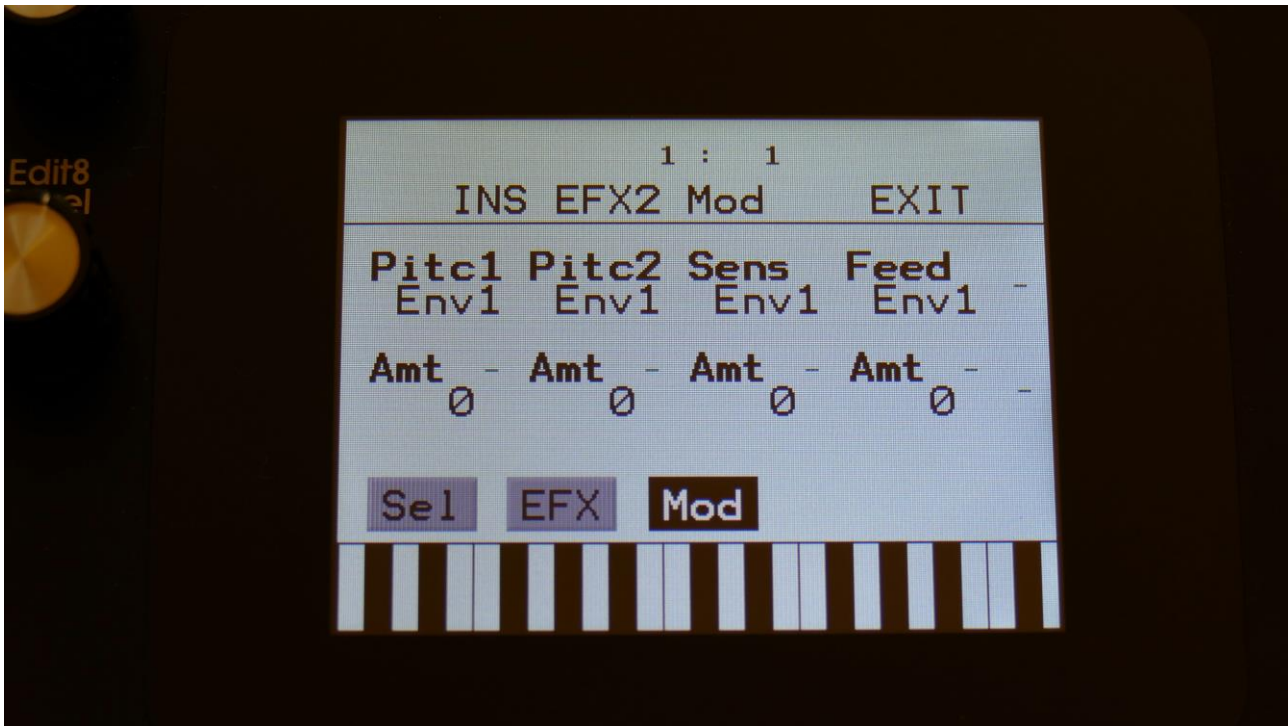

Touch the Mod touch button, to access this page.

The 2 VU-meters at the right of the screen, shows the Effect input and output. The small VU-meters next to the parameters, shows the activity of the selected modulation sources.

For each parameter, that can be modulated, it is possible to select a modulation source, and to adjust the modulation amount. Only the positive modulation sources, can be selected by the Edit Knobs. To make a modulation source negative, touch the modulation source parameter. For a complete list of modulation sources, see the list in the start of this section.

The upper row of parameters selects the modulation sources, **the lower row of parameters** (Labelled Amt) adjusts the modulation amount in the range 0 to 511.

The parameters on this page:

Pitc1 and Pitc2: Modulates the glitch shift parameter.

Sens: Modulates the Sense parameter.

Feed: Modulates the Feed parameter.

Pitch Shaper

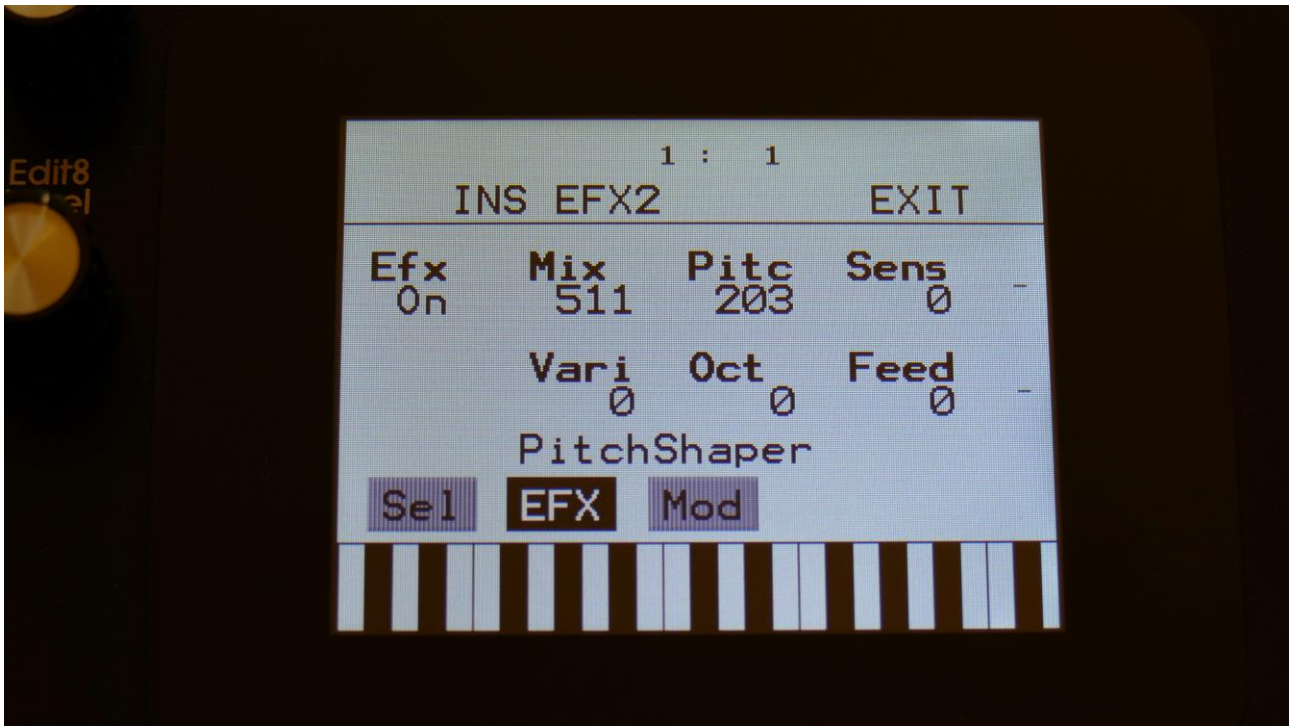

Touch the EFX touch button, to access this page.

The 2 VU-meters at the right of the screen, shows the Effect input and output.

Efx: Off, on. When the effect is off, it is bypassed.

Mix: The mix between the un-effected signal on the effect input, and the effected signal on the effect output.

Pitc: Sets the frequency, that the input signal should be re-pitched to.

Sense: Pitch detection sense. On a pure waveform, turn this fully down to make sure, that it detects all the waves of it, and pitch shifts correctly. On more complex sounds, turn this up until the desired effect are obtained. At higher settings, only portions of the sound will be pitch shifted, and when it doesn't detect any pitch, it will repeat the portion it detected, making the sound "granulate".

Vari: Pitch variation. The more this is turned up, the more the pitch variations on the input signal affects the pitch shaper frequency.

Oct: Octave transpose. From 0 to +3 octaves.

Feed: Pitch shaper feedback. Adjusts the portion of the output signal, that is fed back to the input.

Pitch Shaper Modulation

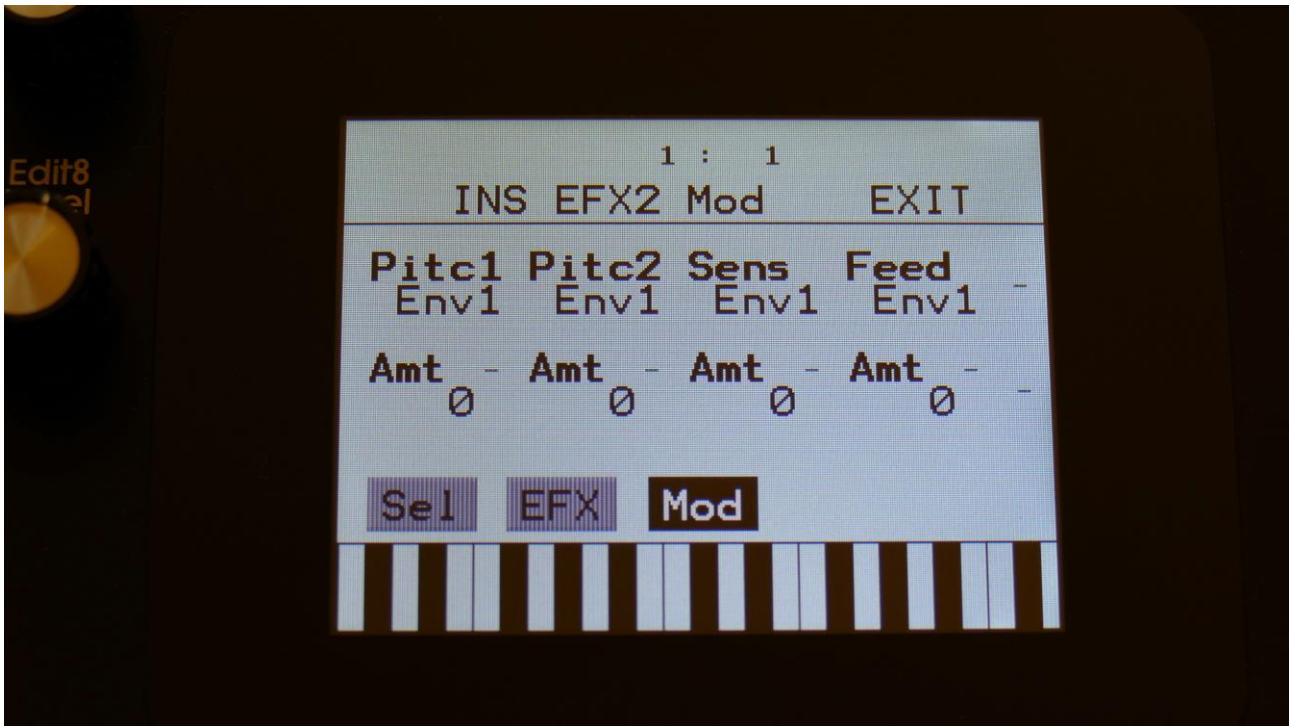

Touch the Mod touch button, to access this page.

The 2 VU-meters at the right of the screen, shows the Effect input and output. The small VU-meters next to the parameters, shows the activity of the selected modulation sources.

For each parameter, that can be modulated, it is possible to select a modulation source, and to adjust the modulation amount. Only the positive modulation sources, can be selected by the Edit Knobs. To make a modulation source negative, touch the modulation source parameter. For a complete list of modulation sources, see the list in the start of this section.

The upper row of parameters selects the modulation sources, **the lower row of parameters** (Labelled Amt) adjusts the modulation amount in the range 0 to 511.

The parameters on this page:

Pitc1 and Pitc2: Modulates the pitc parameter.

Sens: Modulates the Sense parameter.

Feed: Modulates the Feed parameter.

FAT

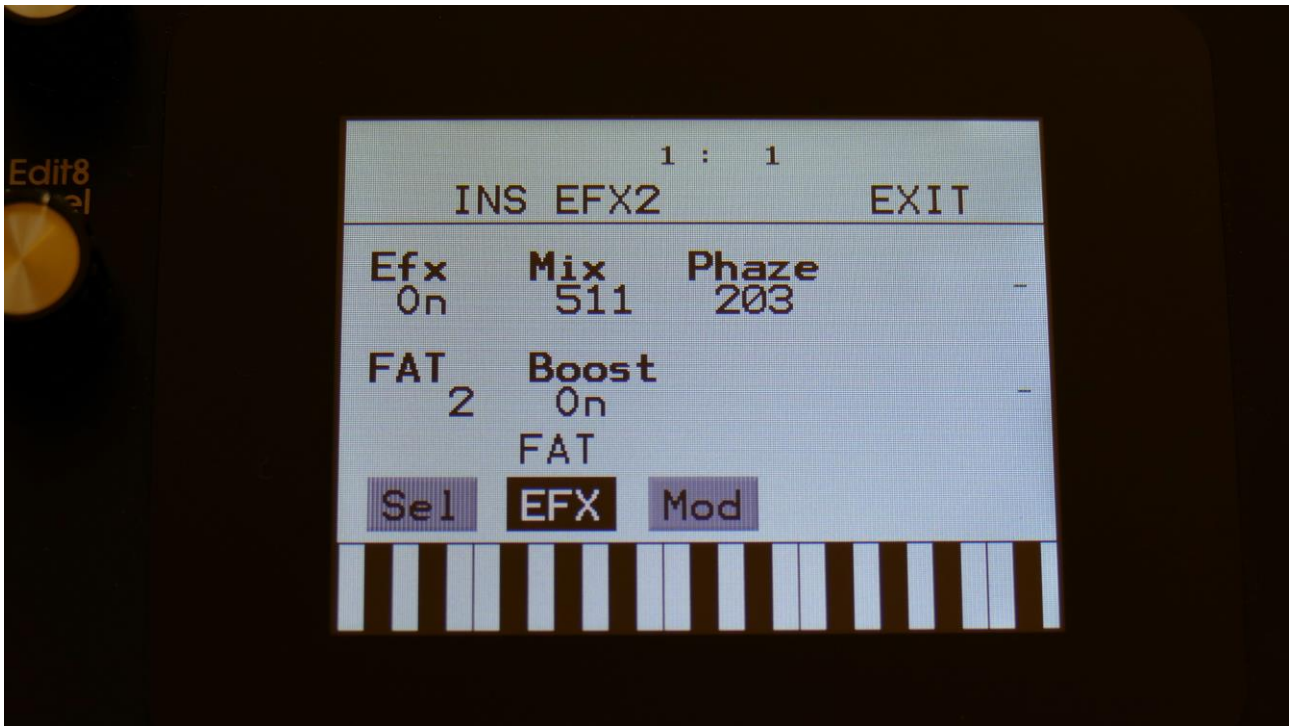

Touch the EFX touch button, to access this page.

The 2 VU-meters at the right of the screen, shows the Effect input and output.

Efx: Off, on. When the effect is off, it is bypassed.

Mix: The mix between the un-effected signal on the effect input, and the effected signal on the effect output.

Phase: Adjusts the phase difference of the FAT layers. When turned fully down, all layers are in phase. The more it is turned up, the more the layers goes out of phase to each other. Useful for creating comb filter type sounds.

FAT: Adds 0 to 3 layers of the input sound to itself.

Boost: When this is on, the FAT layers are sonically added to each other, which will make the sound louder, and might cause it to saturate. If it is off, the sound stays at its original sonic level, even when layers are added.

FAT Modulation

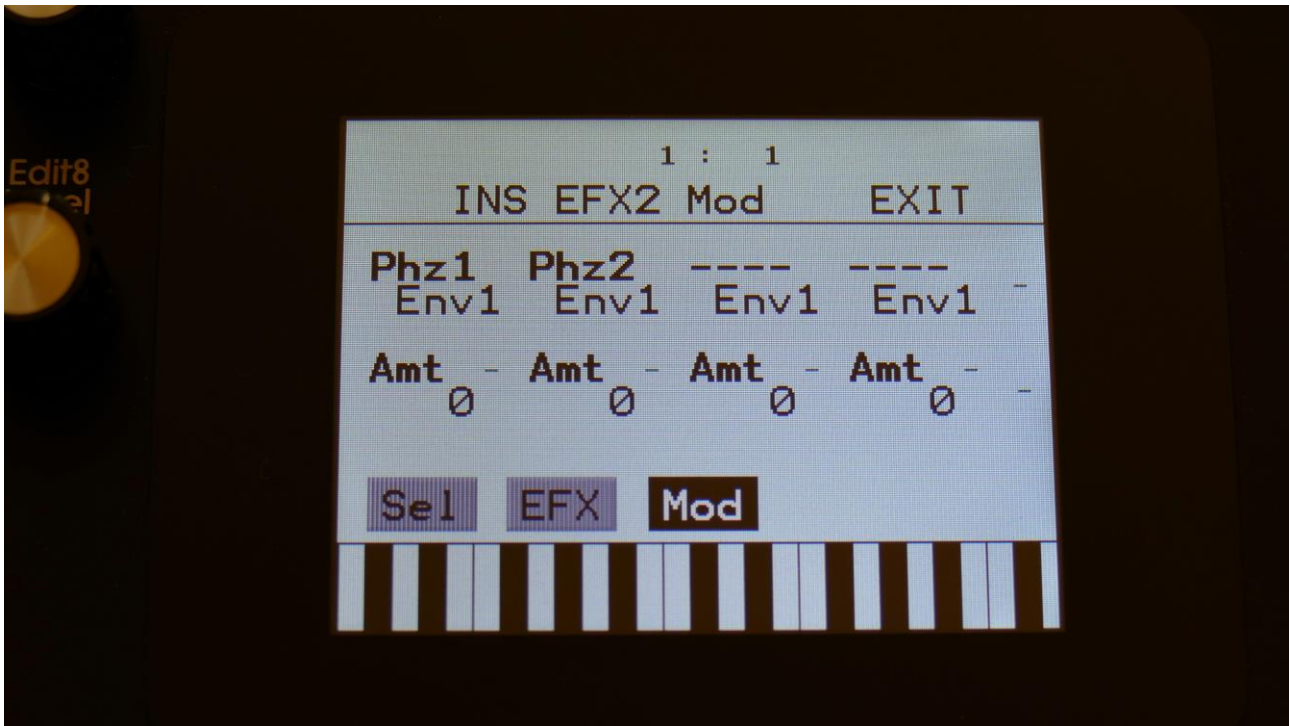

Touch the Mod touch button, to access this page.

The 2 VU-meters at the right of the screen, shows the Effect input and output. The small VU-meters next to the parameters, shows the activity of the selected modulation sources.

For each parameter, that can be modulated, it is possible to select a modulation source, and to adjust the modulation amount. Only the positive modulation sources, can be selected by the Edit Knobs. To make a modulation source negative, touch the modulation source parameter. For a complete list of modulation sources, see the list in the start of this section.

The upper row of parameters selects the modulation sources, **the lower row of parameters** (Labelled Amt) adjusts the modulation amount in the range 0 to 511.

The parameters on this page:

Phz1 and Phz2: Modulates the Phaze parameter.

Filters

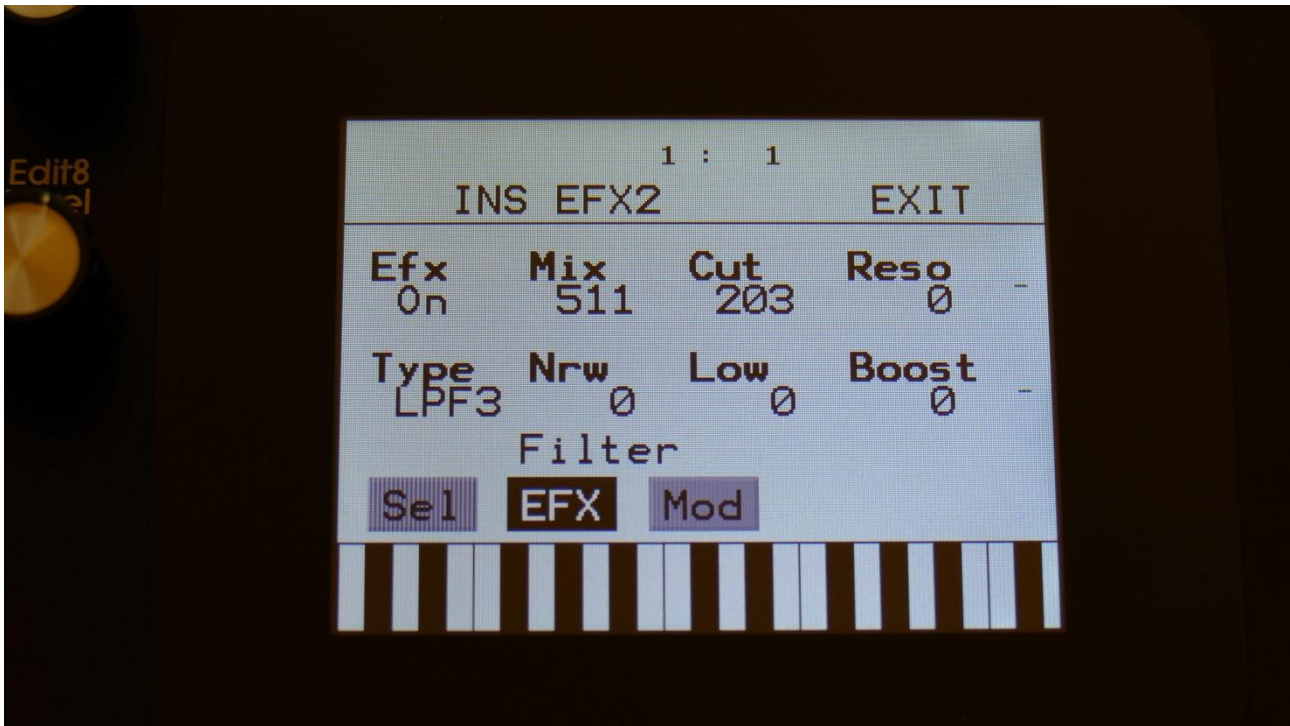

The filter types:

LPF1: Lowpass filter with a rather weak character. Resonance does not self-oscillate.

LPF2: Lowpass filter that are a bit sharper than LPF1. Resonance does not self-oscillate.

LPF3: Sharp Lowpass filter with self-oscillating resonance.

LPF4: Very sharp Lowpass filter with self-oscillating resonance.

BPF1: Bandpass filter with a rather weak character. Resonance does not self-oscillate.

BPF2: Bandpass filter with focus on the bass area. Distorts at higher input levels. Resonance does not self-oscillate.

BPF3: Sharp Bandpass filter with self-oscillating resonance.

HPF1: Sharp Highpass filter with self-oscillating resonance.

HPF2: High gained Highpass filter with self-oscillating resonance. Distorts at higher input levels.

HPF3: Sharp Highpass filter with self-oscillating resonance. A bit weaker than HPF1.

Dstr: Destruktion. A rather defective filter. Self-oscillates at some points, distorts at others.

FAT1: Slightly distorting lowpass filter, with a sharp response and self-oscillating resonance.

FAT2: A slightly weaker version of FAT1.

LoFi: A very distorting and unpredictable lowpass filter.

LPF5: A lowpass filter with a very soft character. Resonance does not self-oscillate.

BPF4: A bandpass filter with a very soft character and self-oscillating resonance.

Touch the EFX touch button, to access this page.

The 2 VU-meters at the right of the screen, shows the Effect input and output.

Cut: 0 to 511. Sets the cutoff frequency of the filter.

Reso: 0 to 511. Sets the amount of resonance applied to the filter.

Type: Sets the filter type. See the list of filter types.

Nrw: 0 to 511. Turning this up, will make the frequency response of the filter more and more narrow.

Low: 0 to 511. Sets the lowest frequency offset point of the filter. Turning this up, will in many filter types, make the bass bottom more present or distorted.

Boost: 0 to 511. Gains the filter output level.

Filter Modulation

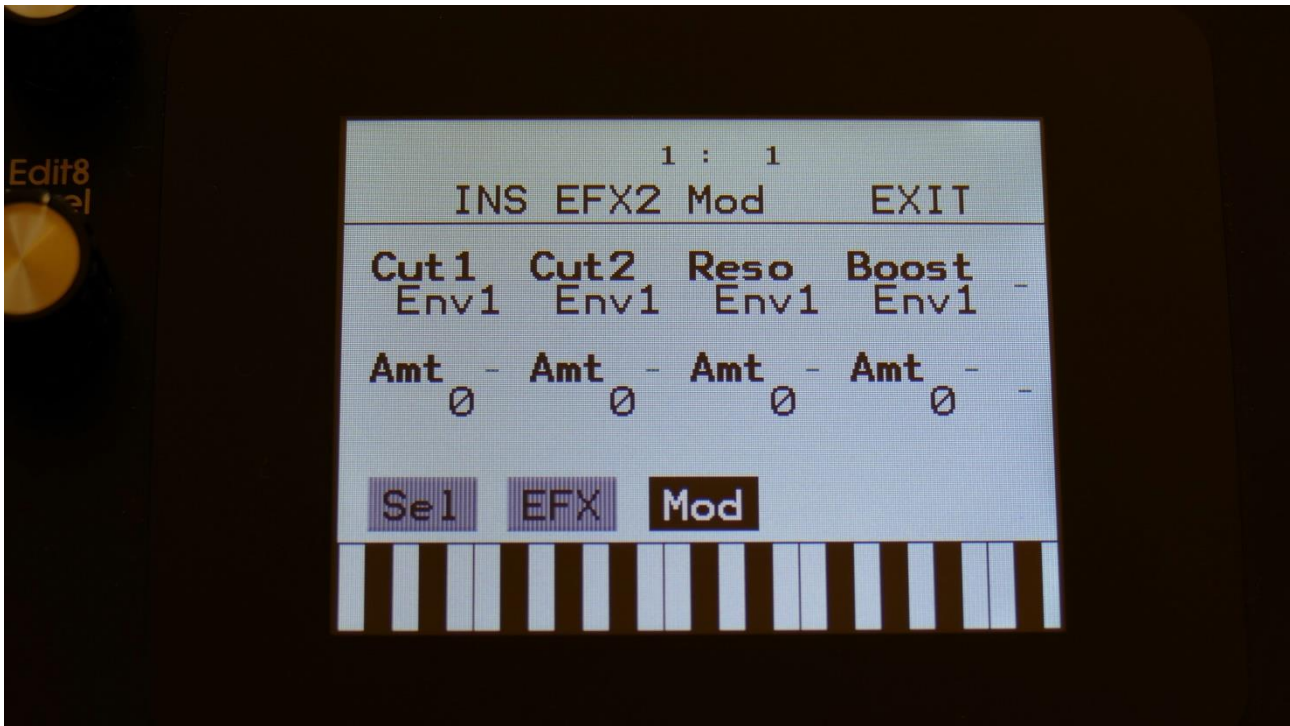

Touch the Mod touch button, to access this page.

The 2 VU-meters at the right of the screen, shows the Effect input and output. The small VU-meters next to the parameters, shows the activity of the selected modulation sources.

For each parameter, that can be modulated, it is possible to select a modulation source, and to adjust the modulation amount. Only the positive modulation sources, can be selected by the Edit Knobs. To make a modulation source negative, touch the modulation source parameter. For a complete list of modulation sources, see the list in the start of this section.

The upper row of parameters selects the modulation sources, **the lower row of parameters** (Labelled Amt) adjusts the modulation amount in the range 0 to 511.

The parameters on this page:

Cut1, Cut2: Will modulate the filter cutoff frequency.

Reso: Will modulate the amount of resonance applied to the filter.

Boost: Will modulate the filter output gaining.

Filters 2

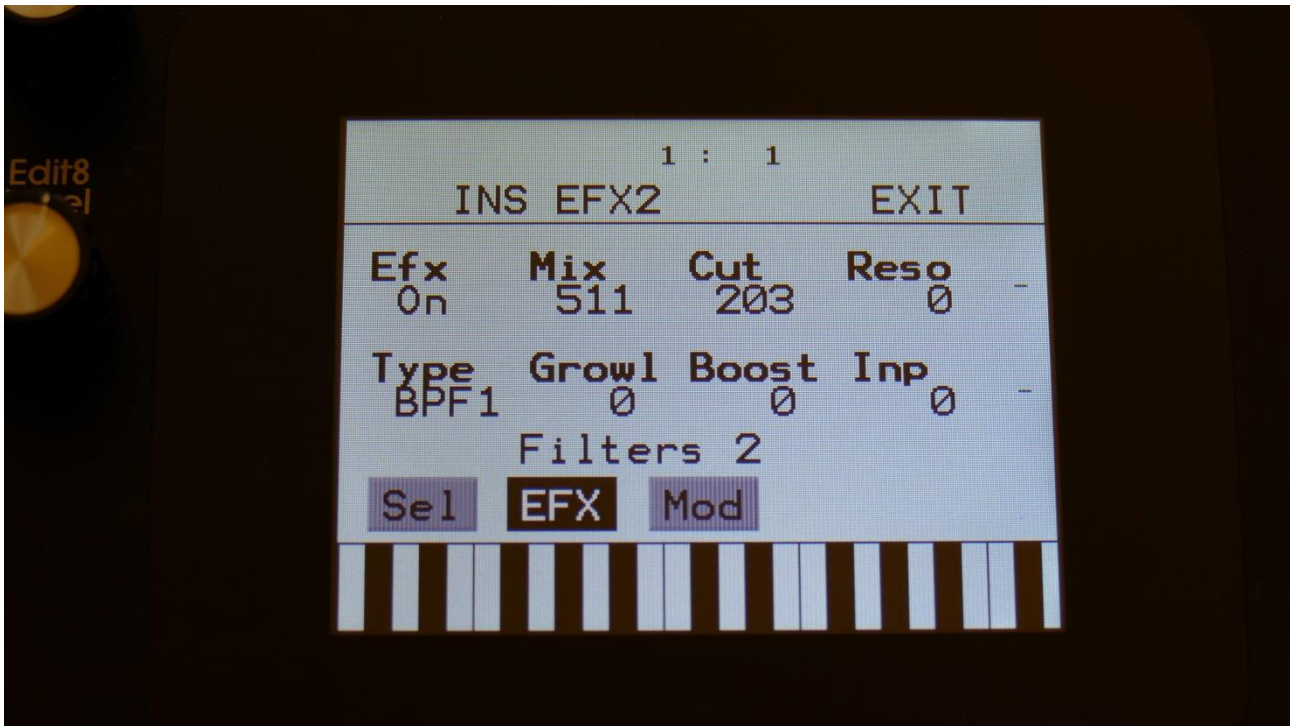

Touch the EFX touch button, to access this page.

The 2 VU-meters at the right of the screen, shows the Effect input and output.

Cut: Filter cutoff frequency.

Reso: Filter resonance setting.

Type: Filter type. Possibilities are:

- HPF1:** High pass filter with extra bass bottom and uncontrollable resonance.
- LPF1:** Low pass filter with extra bass bottom and uncontrollable resonance.
- BPF1:** Band pass filter with extra bass bottom and uncontrollable resonance.
- HPF2:** High pass filter with a thinner and more resonant sound.
- LPF2:** Low pass filter with a thinner and more resonant sound.
- BPF2:** Band pass filter with a thinner and more resonant sound.

Growl: Adds unsymmetric distortion to the filter.

Boost: Adds extra boost to the filter output signal, if desired.

Inp: The input level of the filter.

Filters 2 Modulation

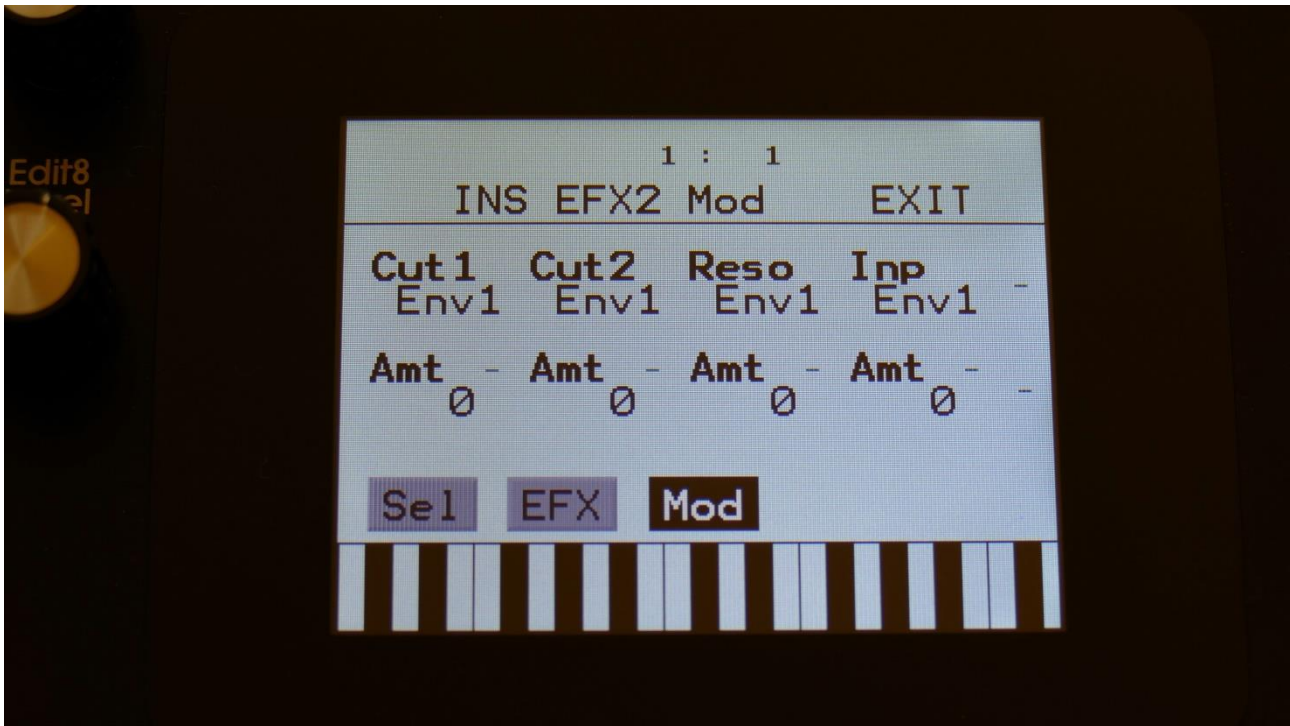

Touch the Mod touch button, to access this page.

The 2 VU-meters at the right of the screen, shows the Effect input and output. The small VU-meters next to the parameters, shows the activity of the selected modulation sources.

For each parameter, that can be modulated, it is possible to select a modulation source, and to adjust the modulation amount. Only the positive modulation sources, can be selected by the Edit Knobs. To make a modulation source negative, touch the modulation source parameter. For a complete list of modulation sources, see the list in the start of this section.

The upper row of parameters selects the modulation sources, **the lower row of parameters** (Labelled Amt) adjusts the modulation amount in the range 0 to 511.

The parameters on this page:

Cut1, Cut2: Modulates the filter cutoff frequency.

Reso: Modulates the filter resonance.

Inp: Modulates the filter input level parameter.

Compressor

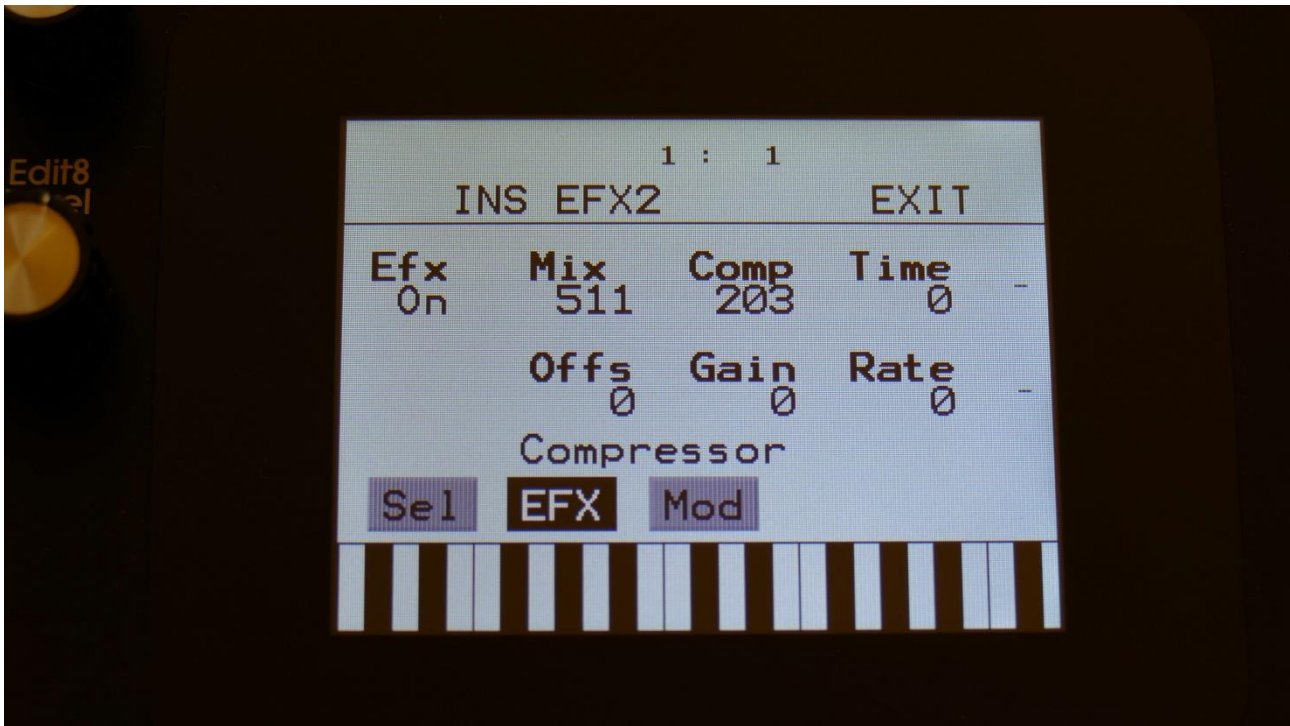

Touch the EFX touch button, to access this page.

The 2 VU-meters at the right of the screen, shows the Effect input and output.

Comp: 0 to 511. Compression amount. The more this is turned up, the more the portion of the signal, that are higher than the offset value, will be damped.

Offs: 0 to 511. Sets the level point where the compression will kick in. The more this is turned up, the higher the input signal will need to be, before it starts to compress.

Gain: 0 to 511. Sets the output gain of the compressor.

Time: 0 to 511. The more this is turned up, the longer time it will take, for the compression to kick in.

Rate: 0 to 511. This sets how fast the compressor will react to level changes of the input signal. The more it is turned up, the slower it will react.

Compressor Modulation

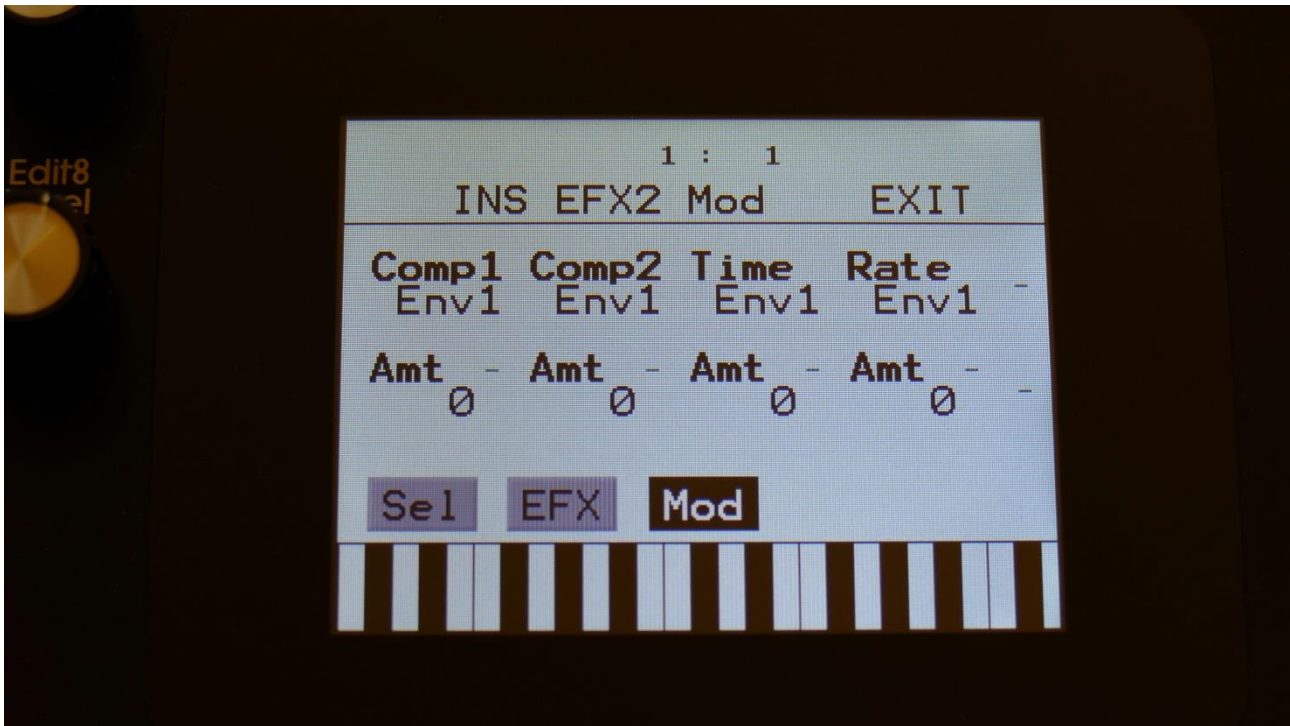

Touch the Mod touch button, to access this page.

The 2 VU-meters at the right of the screen, shows the Effect input and output. The small VU-meters next to the parameters, shows the activity of the selected modulation sources.

For each parameter, that can be modulated, it is possible to select a modulation source, and to adjust the modulation amount. Only the positive modulation sources, can be selected by the Edit Knobs. To make a modulation source negative, touch the modulation source parameter. For a complete list of modulation sources, see the list in the start of this section.

The upper row of parameters selects the modulation sources, **the lower row of parameters** (Labelled Amt) adjusts the modulation amount in the range 0 to 511.

The parameters on this page:

Comp1, Comp2: Will modulate the compression amount.

Time: Will modulate the compression “kick in” time.

Rate: Will modulate the time it takes for the compressor to react to changes on the input signal.

Expander

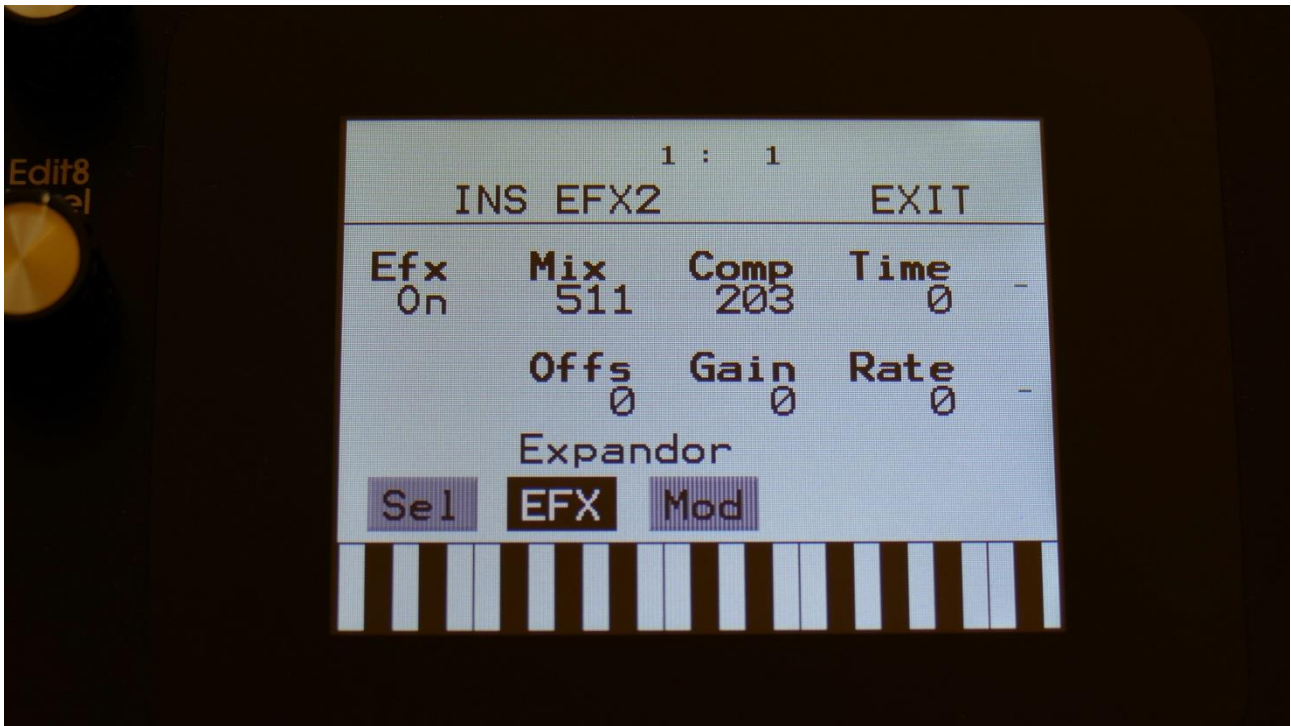

Touch the EFX touch button, to access this page.

The 2 VU-meters at the right of the screen, shows the Effect input and output.

Comp: 0 to 511. Compression amount. The more this is turned up, the more the portion of the signal, that are higher than the offset value, will be gained.

Offs: 0 to 511. Sets the level point where the expansion will kick in. The more this is turned up, the higher the input signal will need to be, before it starts to gain.

Gain: 0 to 511. Sets the output gain of the expander.

Time: 0 to 511. The more this is turned up, the longer time it will take, for the expansion to kick in.

Rate: 0 to 511. This sets how fast the expander will react to level changes of the input signal. The more it is turned up, the slower it will react.

Expander Modulation

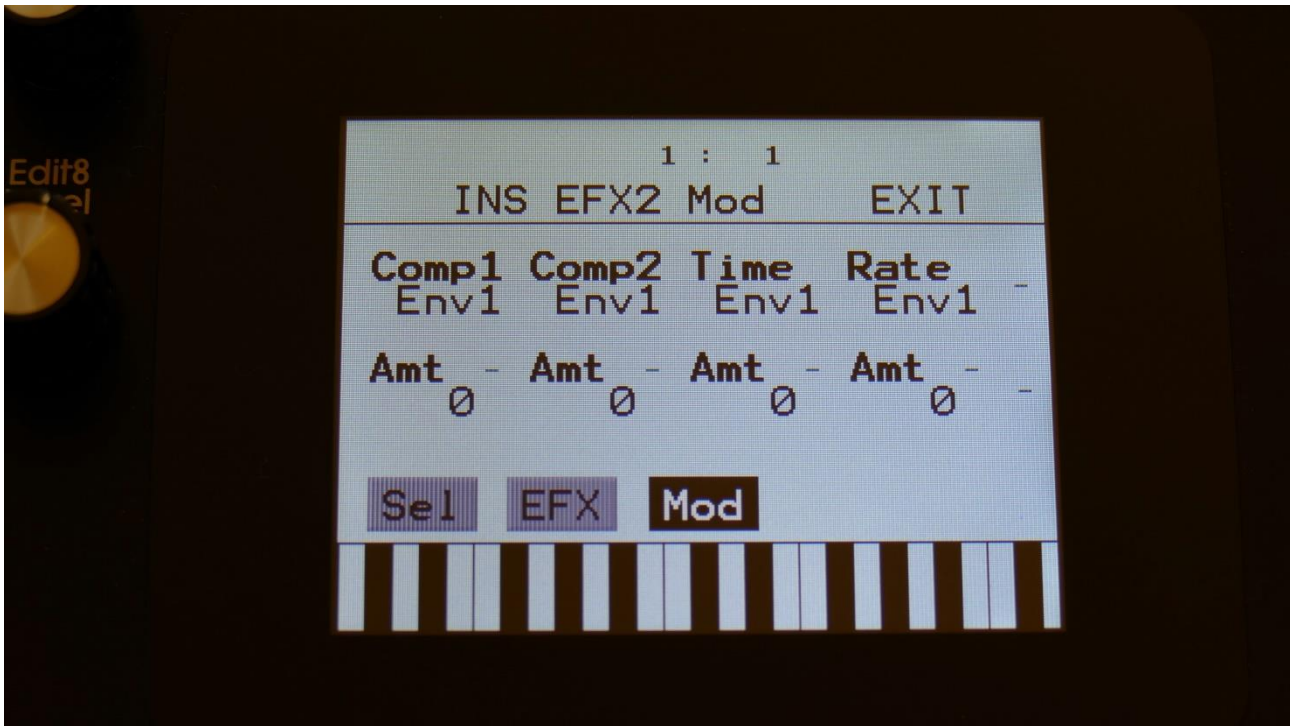

Touch the Mod touch button, to access this page.

The 2 VU-meters at the right of the screen, shows the Effect input and output. The small VU-meters next to the parameters, shows the activity of the selected modulation sources.

For each parameter, that can be modulated, it is possible to select a modulation source, and to adjust the modulation amount. Only the positive modulation sources, can be selected by the Edit Knobs. To make a modulation source negative, touch the modulation source parameter. For a complete list of modulation sources, see the list in the start of this section.

The upper row of parameters selects the modulation sources, **the lower row of parameters** (Labelled Amt) adjusts the modulation amount in the range 0 to 511.

The parameters on this page:

Comp1, Comp2: Will modulate the expansion amount.

Time: Will modulate the expansion “kick in” time.

Rate: Will modulate the time it takes for the expander to react to changes on the input signal.

PitchShaper2

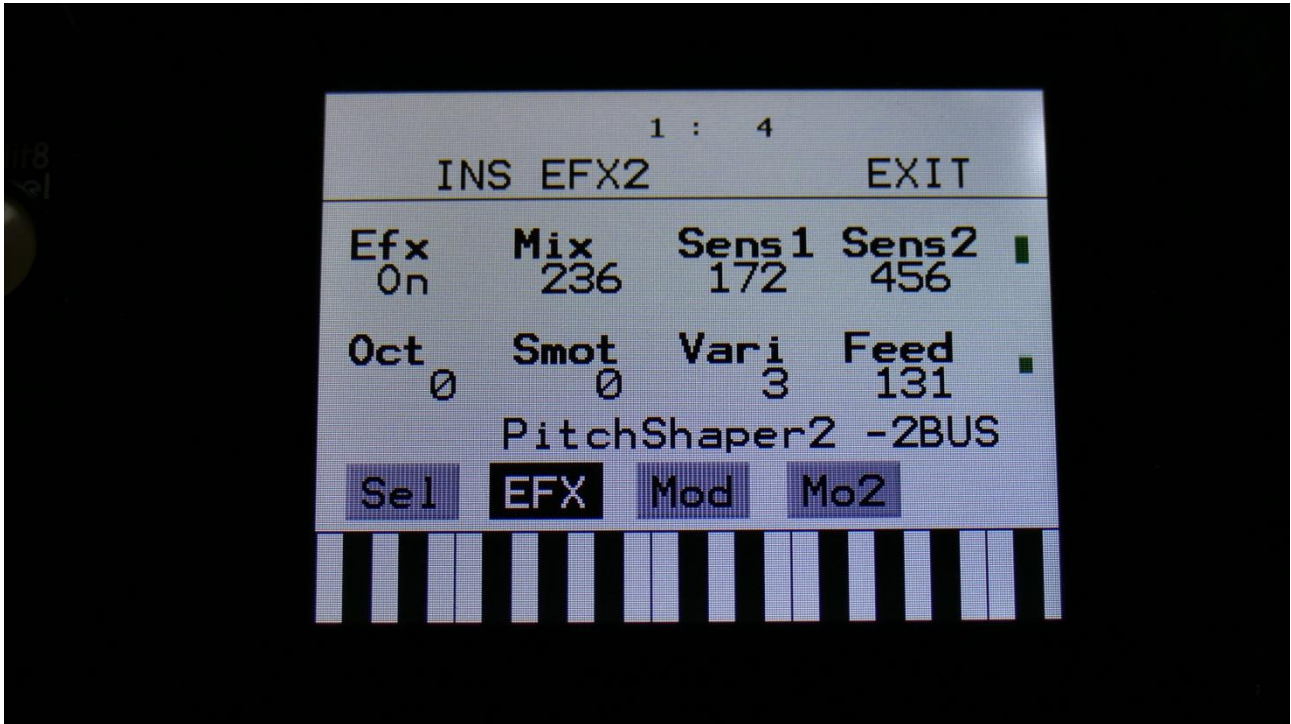

Touch the EFX touch button, to access this page.

The 2 VU-meters at the right of the screen, shows the Effect input and output.

Efx: Off, on. When the effect is off, it is bypassed.

Mix: The mix between the un-effected signal on the effect input, and the effected signal on the effect output.

Sens1: Pitch detection sense input 1. On a pure waveform, turn this fully down to make sure, that it detects all the waves of it, and pitch shifts correctly. On more complex sounds, turn this up until the desired effect are obtained. At higher settings, only portions of the sound will be pitch shifted, and when it doesn't detect any pitch, it will repeat the portion it detected, making the sound "granulate".

Sens2: Pitch detection sense input 2. On a pure waveform, turn this fully down to make sure, that it detects all the waves of it, and pitch shifts correctly. On more complex sounds, turn this up until the desired effect are obtained. At higher settings, only portions of the sound will be pitch shifted, and when it doesn't detect any pitch, it will repeat the portion it detected, making the sound "granulate".

Oct: Octave transpose. From 0 to +3 octaves.

Smot: Smooth. The more this is turned up, the more the changes in pitch are smoothed.

Vari: Pitch variation. The more this is turned up, the more the pitch variations on the input 1 signal affects the pitch shaper frequency.

Feed: Pitch shaper feedback. Adjusts the portion of the output signal, that is fed back to the input.

PitchShaper2 Modulation

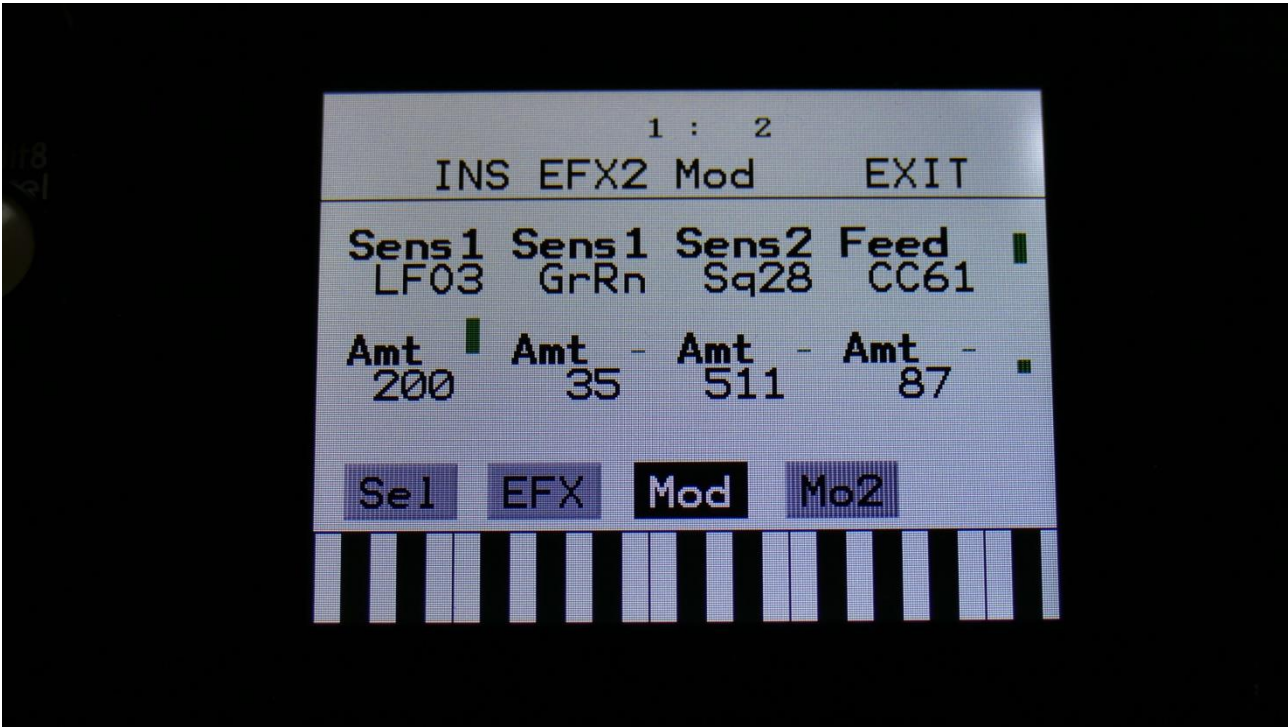

Touch the Mod touch button, to access this page.

The 2 VU-meters at the right of the screen, shows the Effect input and output. The small VU-meters next to the parameters, shows the activity of the selected modulation sources.

For each parameter, that can be modulated, it is possible to select a modulation source, and to adjust the modulation amount. Only the positive modulation sources, can be selected by the Edit Knobs. To make a modulation source negative, touch the modulation source parameter. For a complete list of modulation sources, see the list in the start of this section.

The upper row of parameters selects the modulation sources, **the lower row of parameters** (Labelled Amt) adjusts the modulation amount in the range 0 to 511.

The parameters on this page:

Sens1 and Sens2: Modulates the sens 1 and 2 parameters.

Feed: Modulates the Feed parameter.

Delay1, Roto delay, Bright Delay and Bright Roto Delay



Touch the EFX touch button, to access this page.

The 2 VU-meters at the right of the screen, shows the Effect input and output.

Efx: Off, on. When the effect is off, it is bypassed.

Mix: The mix between the un-effected signal on the effect input, and the effected signal on the effect output.

Deep: Simulates a delay box, with adjustable physical depth.

Time: Delay time.

Xfade: Crossfade. Makes the delay effect sound smoother, by crossfading the feedback repeats into each other.

Feed: Delay feedback amount. At values over middle, the feedback signal will be gained and create infinite feedback. This might cause some saturation.

Delay1, Roto delay, Bright Delay and Bright Roto Delay Modulation

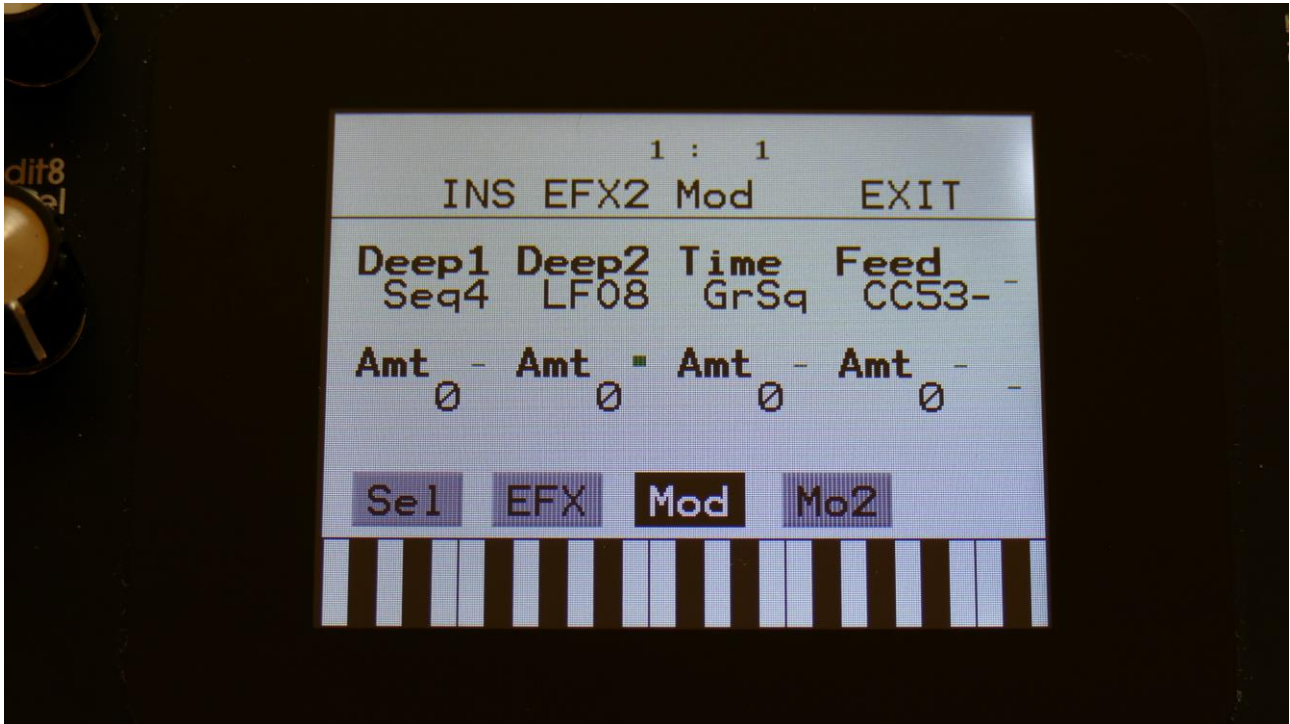

Touch the Mod touch button, to access this page.

The 2 VU-meters at the right of the screen, shows the Effect input and output. The small VU-meters next to the parameters, shows the activity of the selected modulation sources.

For each parameter, that can be modulated, it is possible to select a modulation source, and to adjust the modulation amount. Only the positive modulation sources, can be selected by the Edit Knobs. To make a modulation source negative, touch the modulation source parameter. For a complete list of modulation sources, see the list in the start of this section.

The upper row of parameters selects the modulation sources, **the lower row of parameters** (Labelled Amt) adjusts the modulation amount in the range 0 to 511.

The parameters on this page:

Deep1 and Deep2: Modulates the deep parameter.

Time: Modulates the delay time parameter.

Feed: Modulates the feed parameter.

Variator

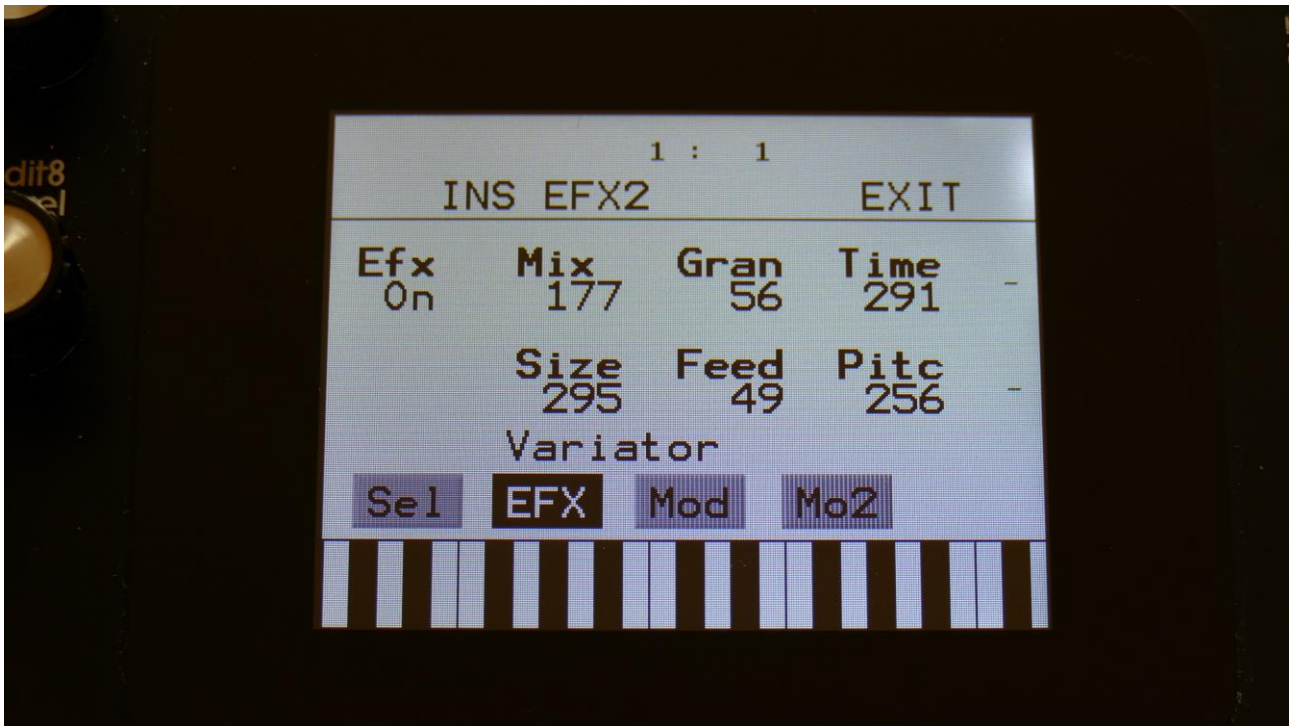

Touch the EFX touch button, to access this page.

The 2 VU-meters at the right of the screen, shows the Effect input and output.

Efx: Off, on, Freeze. When the effect is off, it is bypassed, and its input mixer can function as a mixer. When the effect are in Freeze mode, the input signal is no longer sampled. The sound that the effect holds, will just keep playing back on and on again. NOT ALL EFFECTS ARE AFFECTED BY FREEZE!

Mix: The mix between the un-effected signal on the effect input, and the effected signal on the effect output, that is sent to the audio bus.

Gran: Determines the variation pattern. Range: 0 to 511.

Time: The size of the RAM buffer used for the variator.

Size: The size of one grain.

Feed: Adjusts how much of the Variator output signal should be fed back to its input.

Pitc: The amount of Variator pitch shift.

Variator Modulation

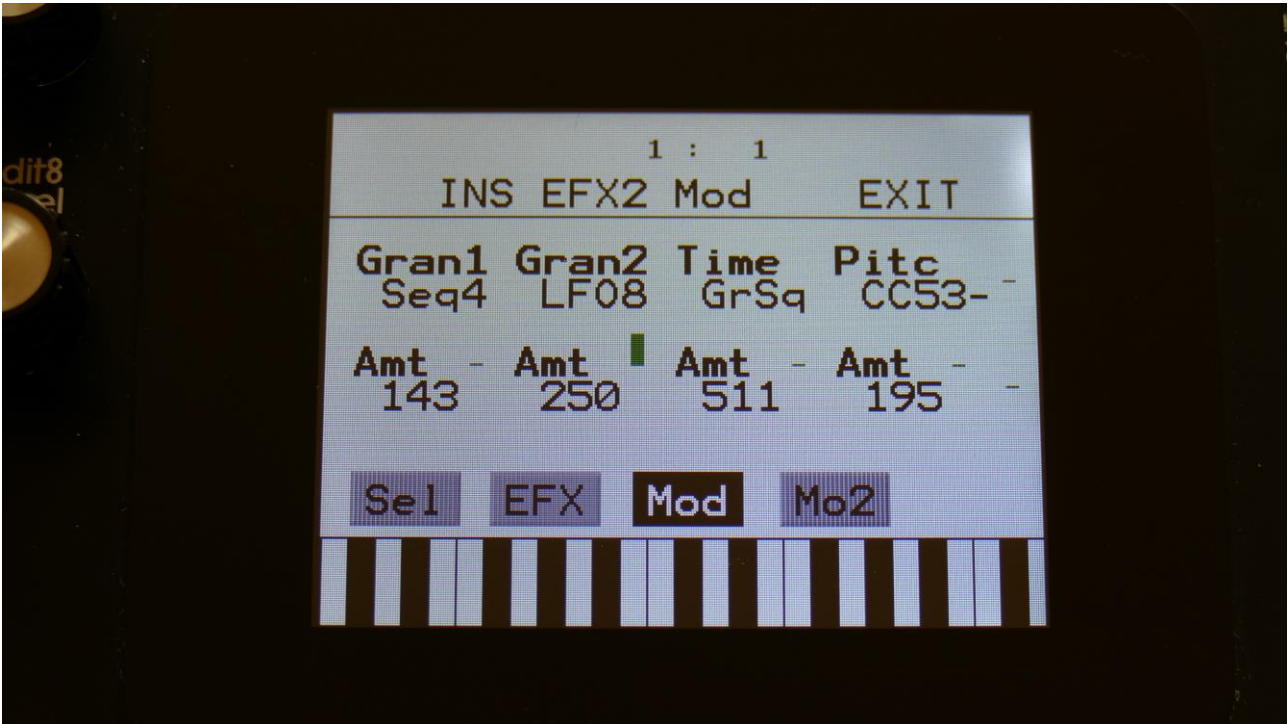

Touch the Mod touch button, to access this page.

The 2 VU-meters at the right of the screen, shows the Effect input and output. The small VU-meters next to the parameters, shows the activity of the selected modulation sources.

For each parameter, that can be modulated, it is possible to select a modulation source, and to adjust the modulation amount. Only the positive modulation sources, can be selected by the Edit Knobs. To make a modulation source negative, touch the modulation source parameter. For a complete list of modulation sources, see the list in the start of this section.

The upper row of parameters selects the modulation sources, **the lower row of parameters** (Labelled Amt) adjusts the modulation amount in the range 0 to 511.

The parameters on this page:

Gran1 and Gran2: Modulates the gran variation pattern parameter.

Time: Modulates the time parameter.

Pitec: Modulates the pitch shift parameter.

Time Stretch

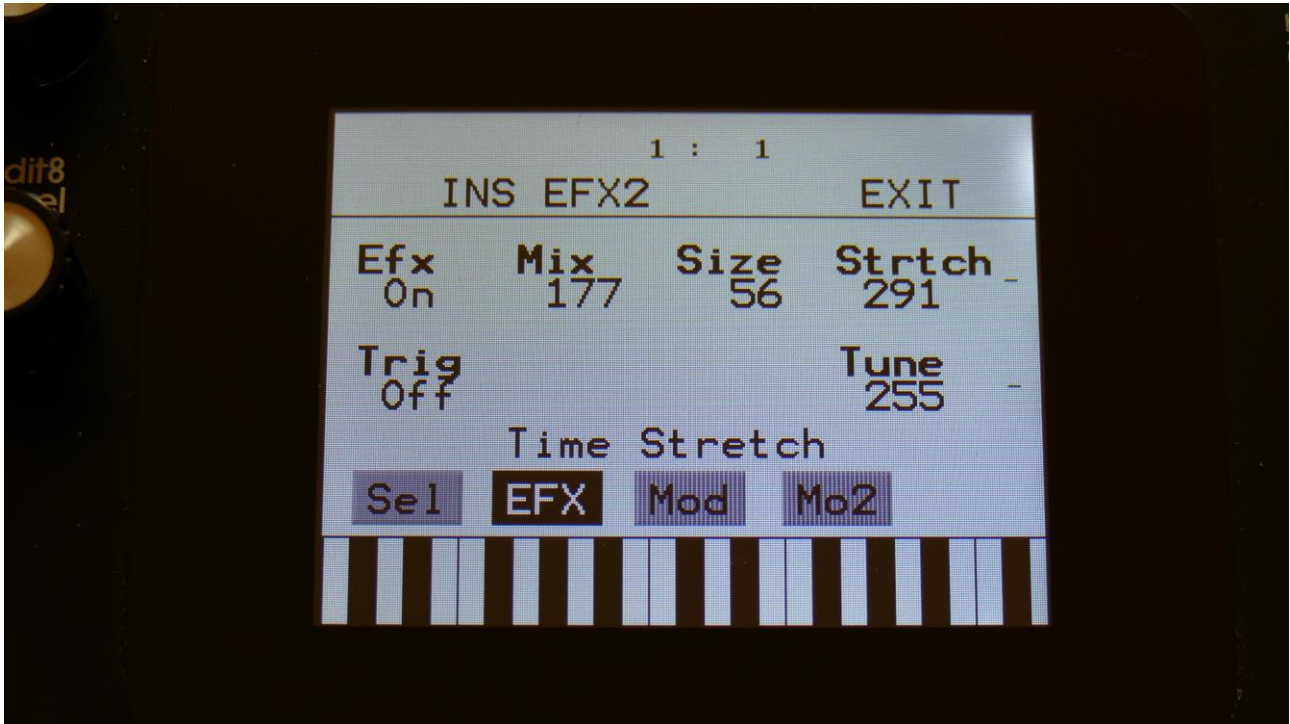

Touch the EFX touch button, to access this page.

The 2 VU-meters at the right of the screen, shows the Effect input and output.

Efx: Off, on. When the effect is off, it is bypassed.

Mix: The mix between the un-effected signal on the effect input, and the effected signal on the effect output.

Size: 0 to 511. The size of the RAM buffer used for the TimeStretcher.

Strtch: 0 to 511. Time stretch. A value below 256 will stretch the sound longer, a value above 256 will compress the sound to become shorter.

Trig: Off, 1 to 16. Determines if the time stretch effect should be triggered by a part or not.

Tune: Pitch Coarse. A value below 256 will pitch the signal down, a value above 256 will pitch it up.

Time Stretch Modulation

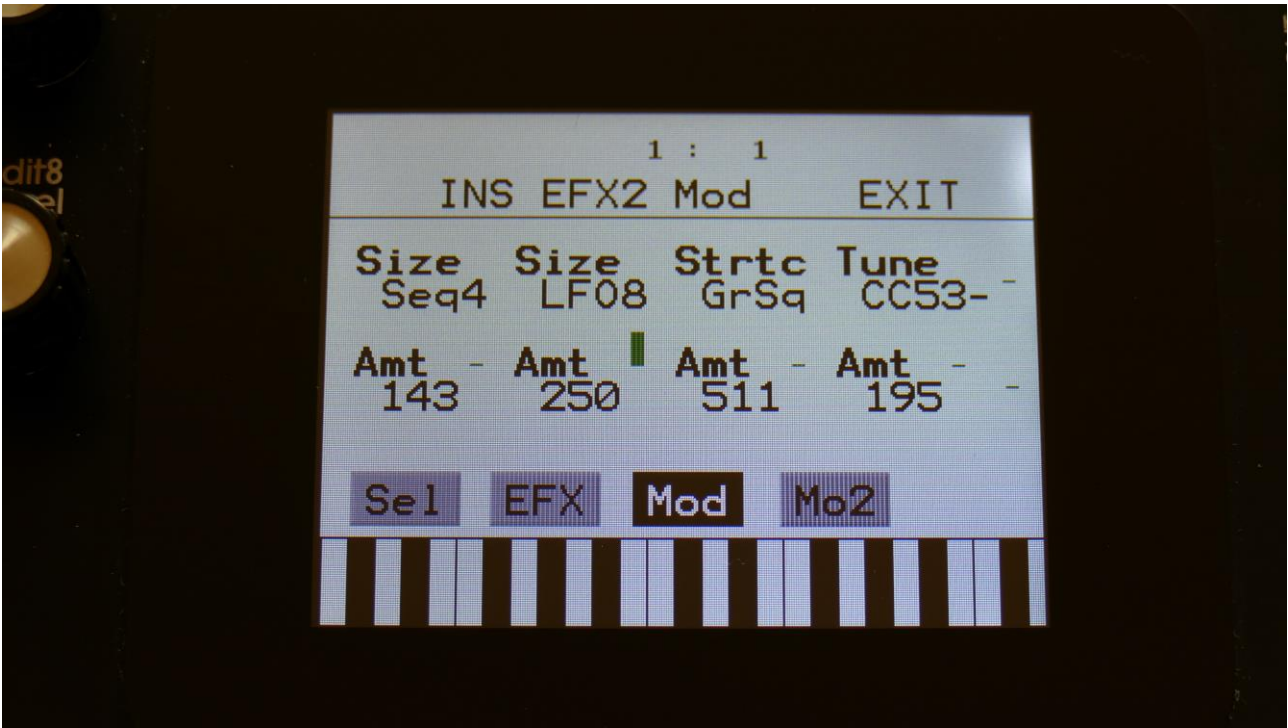

Touch the Mod touch button, to access this page.

The 2 VU-meters at the right of the screen, shows the Effect input and output. The small VU-meters next to the parameters, shows the activity of the selected modulation sources.

For each parameter, that can be modulated, it is possible to select a modulation source, and to adjust the modulation amount. Only the positive modulation sources, can be selected by the Edit Knobs. To make a modulation source negative, touch the modulation source parameter. For a complete list of modulation sources, see the list in the start of this section.

The upper row of parameters selects the modulation sources, **the lower row of parameters** (Labelled Amt) adjusts the modulation amount in the range 0 to 511.

The parameters on this page:

Size: Modulates the size of the time stretch input buffer.

Strtc: Modulates the time stretching.

Tune: Modulates the pitch coarse.

Sample Pitch

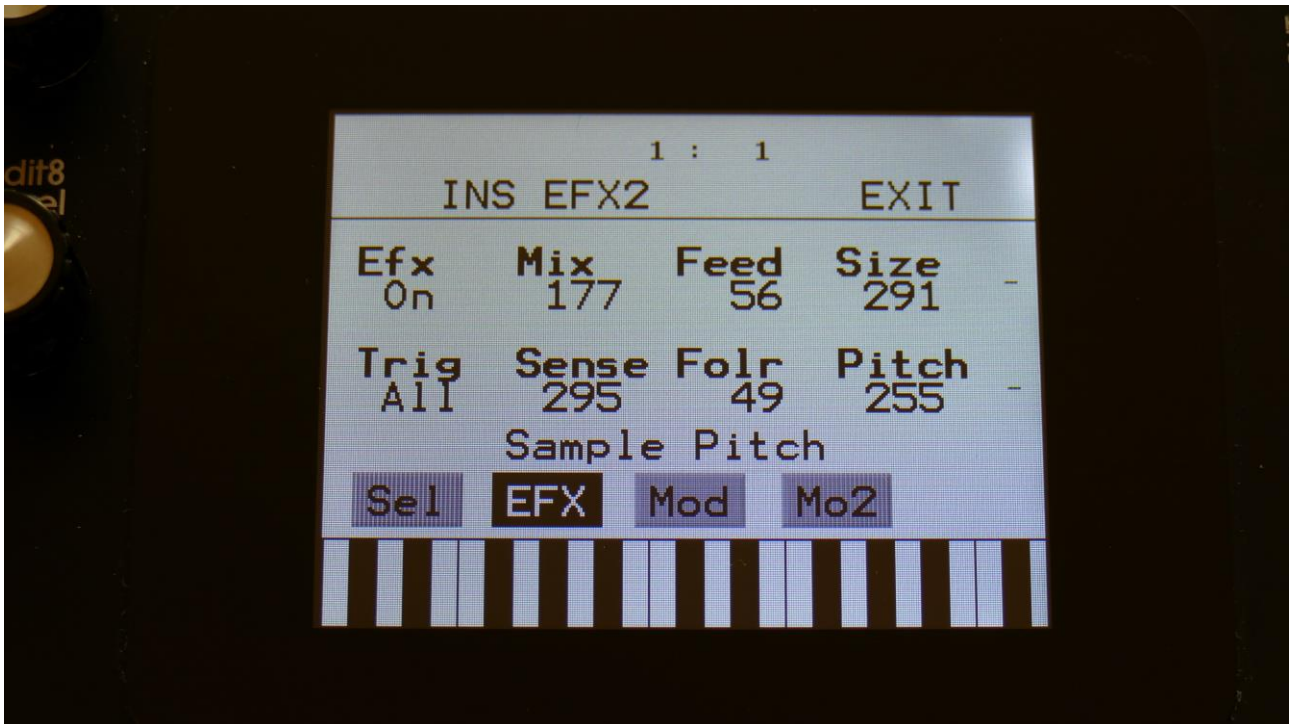

Touch the EFX touch button, to access this page.

The 2 VU-meters at the right of the screen, shows the Effect input and output.

Efx: Off, on. When the effect is off, it is bypassed.

Mix: The mix between the un-effected signal on the effect input, and the effected signal on the effect output.

Feed: Sets how much of the effect output signal should be fed back to its input.

Size: 0 to 511. The number of wave frames used for each pitch grain.

Trig: Off, 1 to 16, OffM, 1M to 16M. Determines if the sample pitch effect should be triggered by all parts or a single part. The "M" suffix indicates that the playback pointer will be moving in another pattern, that will give slightly different results.

Folr: The sample pitch effect output envelope follower rate.

Pitch: The playback pitch. Values below 256 will tune down, values above 256 will tune up.

Sample Pitch Modulation

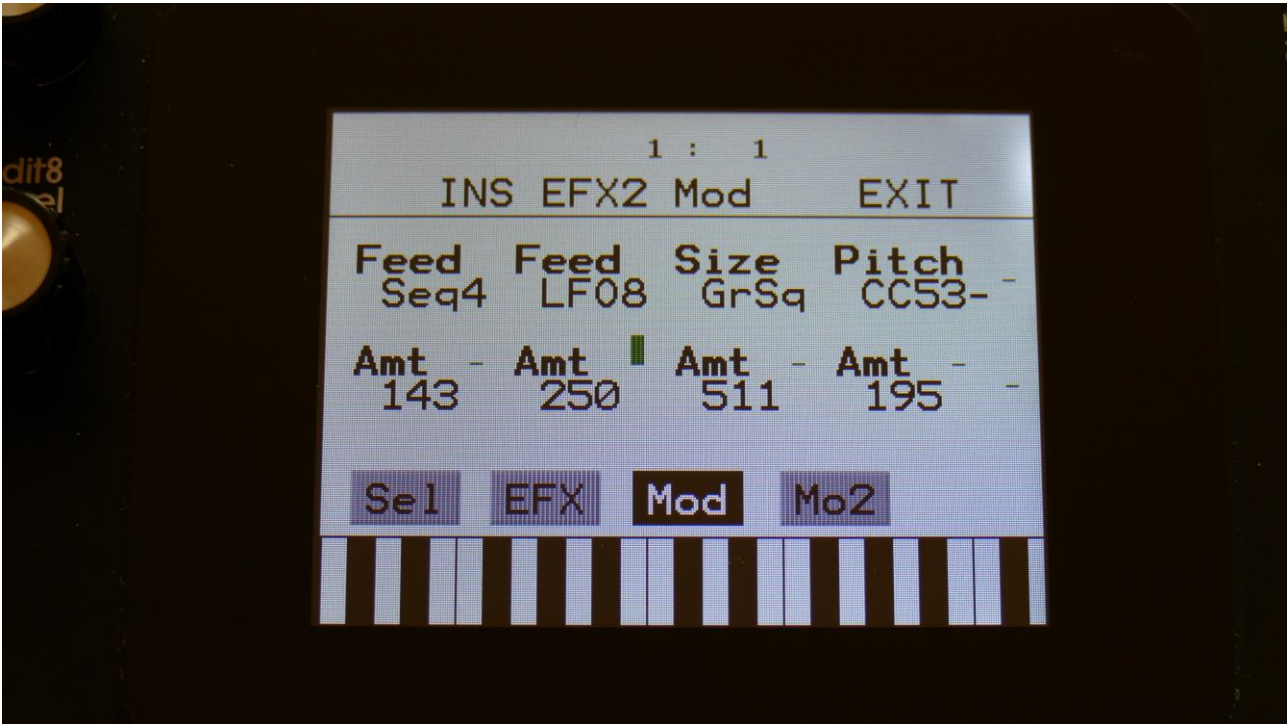

Touch the Mod touch button, to access this page.

The 2 VU-meters at the right of the screen, shows the Effect input and output. The small VU-meters next to the parameters, shows the activity of the selected modulation sources.

For each parameter, that can be modulated, it is possible to select a modulation source, and to adjust the modulation amount. Only the positive modulation sources, can be selected by the Edit Knobs. To make a modulation source negative, touch the modulation source parameter. For a complete list of modulation sources, see the list in the start of this section.

The upper row of parameters selects the modulation sources, **the lower row of parameters** (Labelled Amt) adjusts the modulation amount in the range 0 to 511.

The parameters on this page:

Feed: Modulates the feed parameter.

Size: Modulates the number of waveframes, used for the pitch shifting.

Pitch: Modulates the pitch shifting.

Output Effects 1 and 2

LD3 has 2 output effects processors, that the audio busses can be sent to, and that are outputted to the main L and R outputs with pan control.

Both effects has a bypass switch, Freeze modulation, and a mix parameter.

Any of the 8 audio busses can be inserted in the feedback loop of an output effect. This lets you add other effects and filters inside the feedback loop of the output effect, for new effect possibilities. Add a lowpass filter to make the feedback sound get more and more dark. Add a pitch shifter in a delay loop, for a pitch shifting delay effect. There are really many possibilities with this.

Busses that are assigned to an output effect feedback loop, will no longer output to the audio outputs, that they were assigned to.

The 2 effects can be linked together, for true stereo processing. When an effect is linked to another effect, any parameter tweaks on the source effect, will be mirrored to the linked effect. When switching link off, the parameter settings of the linked effect is kept, so it is possible to make some adjustments, if you don't want the 2 effects to be exactly alike.

List of Output Effects

Delay 1 – Delay with time and feedback controls, plus Gotharman's Deep, Size, Beam and Xfade controls. Deep adds space to the delay, Size makes the playback range more narrow than the input recording range, and beam beams the delay to previously unknown places. The Xfade control on this delay, creates valleys between the delay taps. The more it is turned up, the more time the valleys takes up.

Roto Delay – This is a 2 tap delay, that is constantly crossfading between the 2 taps. When the Xfade control is turned down, the crossfading is rough, the more it is turned up, the more smooth the crossfading gets. Other controls are the same as the first delay.

Bright Delay – First delay, but with a brighter sound, created by a resonator.

Bright Roto Delay – Roto delay, but with a brighter sound, created by a resonator.

Granulator SQ – Cuts the input signal up in grains, that can be re-arranged. This granulator is synced to the sequencer.

Variator – Creates new variations of the input signal. Both pitch and rhythmic variations.

Reverb – A FAT high resolution synthesized reverb with granular Size parameter.

Granulator (unsynced) - Cuts the input signal up in grains, that can be re-arranged, using the step values of a selectable controller sequencer track.

This is the granulator that was named "AnaGran" in earlier Gotharman instruments. Unlike the Granulator SQ, this is not synced to the sequencer. It plays back one grain, and then it immediately advances to the next grain. The values for the granular sequence, is still taken from a selectable sequencer controller track.

Xfade Granulator - Cuts the input signal up in grains, that can be re-arranged, using the step values of a selectable controller sequencer track. This granulator plays back one grain, and then it crossfades to the next grain.

It is also possible to adjust and modulate the pitch of the granular sequence, using any modulation source.

Abstract0 - This effect constantly records the audio applied to its input, in a time interval determined by a "Rec" parameter. It uses 2 "playback heads" to play back the recorded audio. Each of these playback heads can be switched on and off, and the playback length can be adjusted for each of them. Every time a head has played back the adjusted amount of time, it jumps to a new random location of the recorded piece, and starts play back again. The playback pitch of head 2 can be adjusted.

Time Stretch - This effect is able to change the length of the input signal, almost without changing the pitch. Old fashioned time stretch done in realtime, that can be applied even to live input signals! It is also possible to change the pitch if desired, and it is possible to trigger this effect, for bigger precision.

Sample Pitch - Changes the pitch of a sampling, without changing the length, using granular technology. It is possible to set the size of each pitch grain, to generate great granular effects. This effect has to be triggered from any of the parts, in order to function properly. It will work on external signals, but it still needs to be triggered by a part.

Output effects Select page

From the synth parts main page, touch EFX to enter the effect pages. OR: Push and release the Func/Mute button, so that it lights up, and push step button 11/EFX 1 time.

Push and hold the Steps/Part button, while pushing step button 1 to 10.

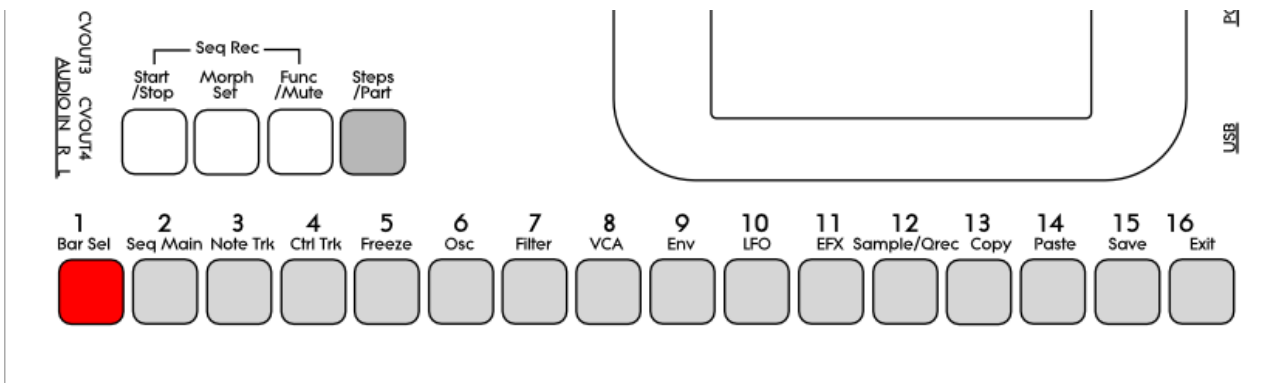

Part 1 is insert effect 1

Part 2 is insert effect 2

Part 3 is insert effect 3

-

Part 8 is insert effect 8

Part 9 is output effect 1

Part 10 is output effect 2

The effects are selected separately from the parts. So Output Effect 2 can for instance be selected, at the same time as part 4 is selected.

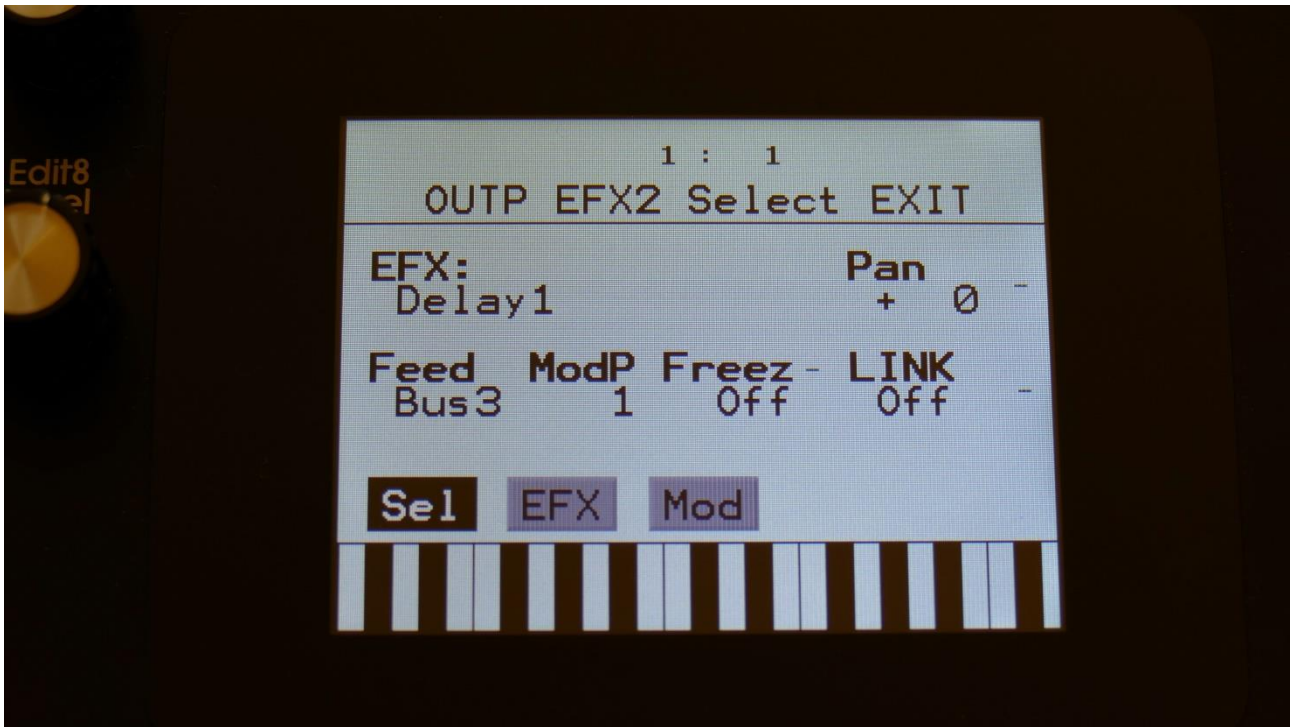

Touch the SEL touch button, to enter the effect select page.

The 2 VU-meters at the right of the screen, shows the Effect input and output activity.

EFX: Selects the effect. Please see the List Of Output Effects in the beginning of this section.

Feed: Int, Bus1 to Bus8. Feedback loop Audio Bus. If set to any other value than Int, the selected audio bus is placed inside the feedback loop of the effect. This lets you add other effects and filters inside the feedback loop of the output effect, for new effect possibilities. Add a lowpass filter to make the feedback sound get more and more dark. Add a pitch shifter in a delay loop, for a pitch shifting delay effect. There are really many possibilities with this.

ModP: 1 to 16. Modulation source part. Selects the synth part, from which the output effect will get the modulation sources, selected on the modulation page.

Freez: Freeze modulation. Can be set to off, Freeze button (Buton) or to any modulation source. When set to any other value than off, the effect will freeze, when the modulation source are in its upper range. When an effect freezes, it no longer samples its audio input signal, but only outputs whatever it already holds in its audio buffer.

Link: Output effect 2 can be linked to effect 1 for true stereo effects processing.

On the **Output Effect 1** select page, the Link parameter is replaced by an Outp parameter:

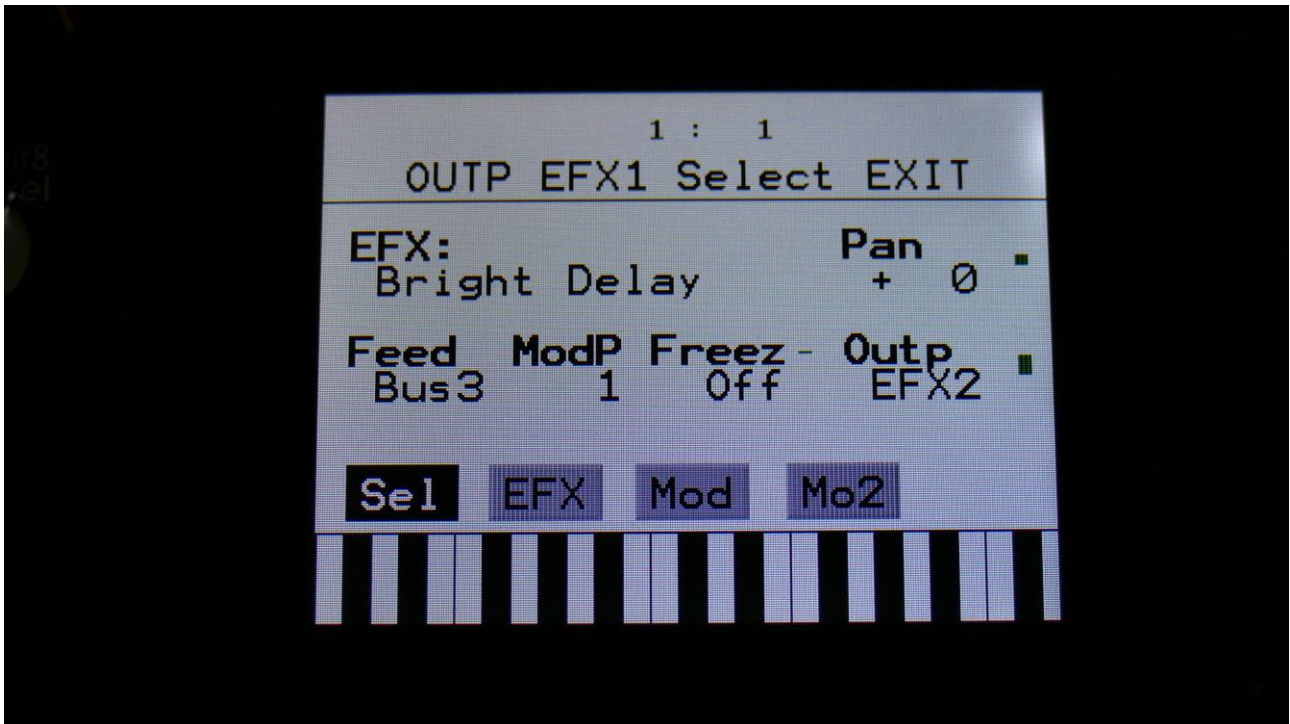

By this parameter, it is possible to send the audio output of Output Effect 1 to either the left and right audio outputs, by setting it to **L+R**, or to Output Effect 2, by setting it to **EFX2**, for serial connection of the 2 Output Effects.

Output Effects parameters

Mix and Pan Modulation, Backwards Delay

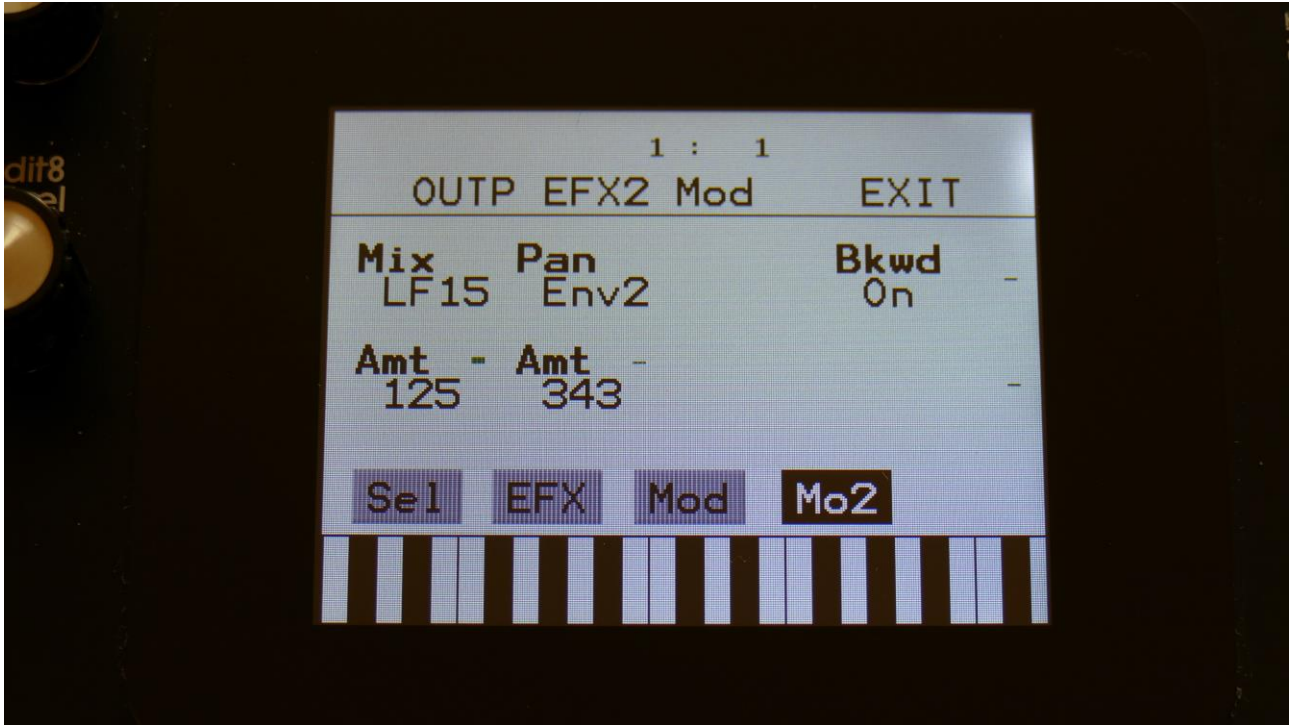

The Effect dry/wet mix and the panning can be modulated on both Output effects.

Touch the MO2 touch button, to access this page.

The 2 VU-meters at the right of the screen, shows the Effect input and output. The small VU-meters next to the parameters, shows the activity of the selected modulation sources.

For each parameter, that can be modulated, it is possible to select a modulation source, and to adjust the modulation amount. Only the positive modulation sources, can be selected by the Edit Knobs. To make a modulation source negative, touch the modulation source parameter. For a complete list of modulation sources, see the list in the start of this section.

The upper row of parameters selects the modulation sources, **the lower row of parameters** (Labelled Amt) adjusts the modulation amount in the range 0 to 511.

The parameters on this page:

Mix: Modulates the effect dry/wet mix.

Pan: Modulates the effect output panning.

Bkwd: This is only visible, when a delay effect is selected. When turned on, the delay effect will play back backwards.

Delay1, Roto delay, Bright Delay and Bright Roto Delay

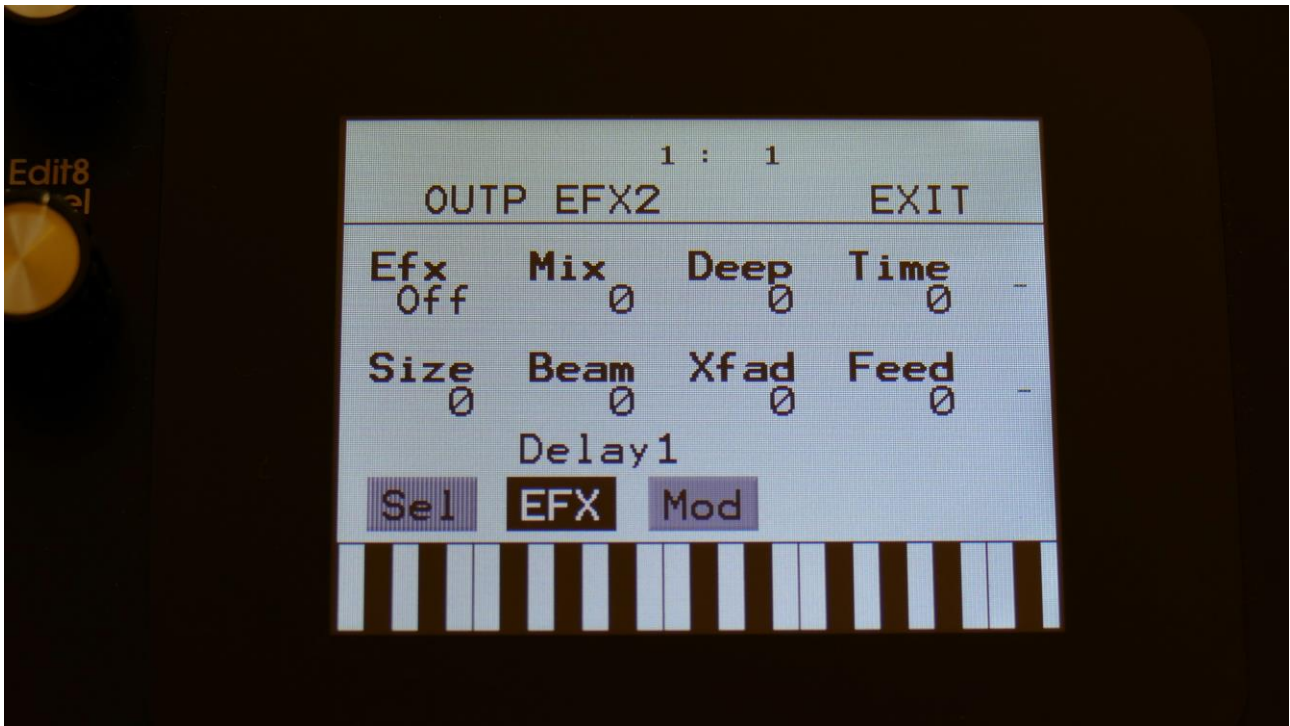

Touch the EFX touch button, to access this page.

The 2 VU-meters at the right of the screen, shows the Effect input and output.

Efx: Off, on. When the effect is off, it is bypassed.

Mix: The mix between the un-effected signal on the effect input, and the effected signal on the effect output.

Deep: Simulates a delay box, with adjustable physical depth.

Time: Delay time.

Size: A granular parameter. The more this is turned up, the less space of the delay box is used, causing some echo's to repeat, and others not to sound at all.

Beam: A granular parameter, that "beams" some of the delay sound grains to another place.

Xfade: Crossfade. Makes the delay effect sound smoother, by crossfading the feedback repeats into each other.

Feed: Delay feedback amount. At values over middle, the feedback signal will be gained and create infinite feedback. This might cause some saturation.

Delay1, Roto delay, Bright Delay and Bright Roto Delay Modulation

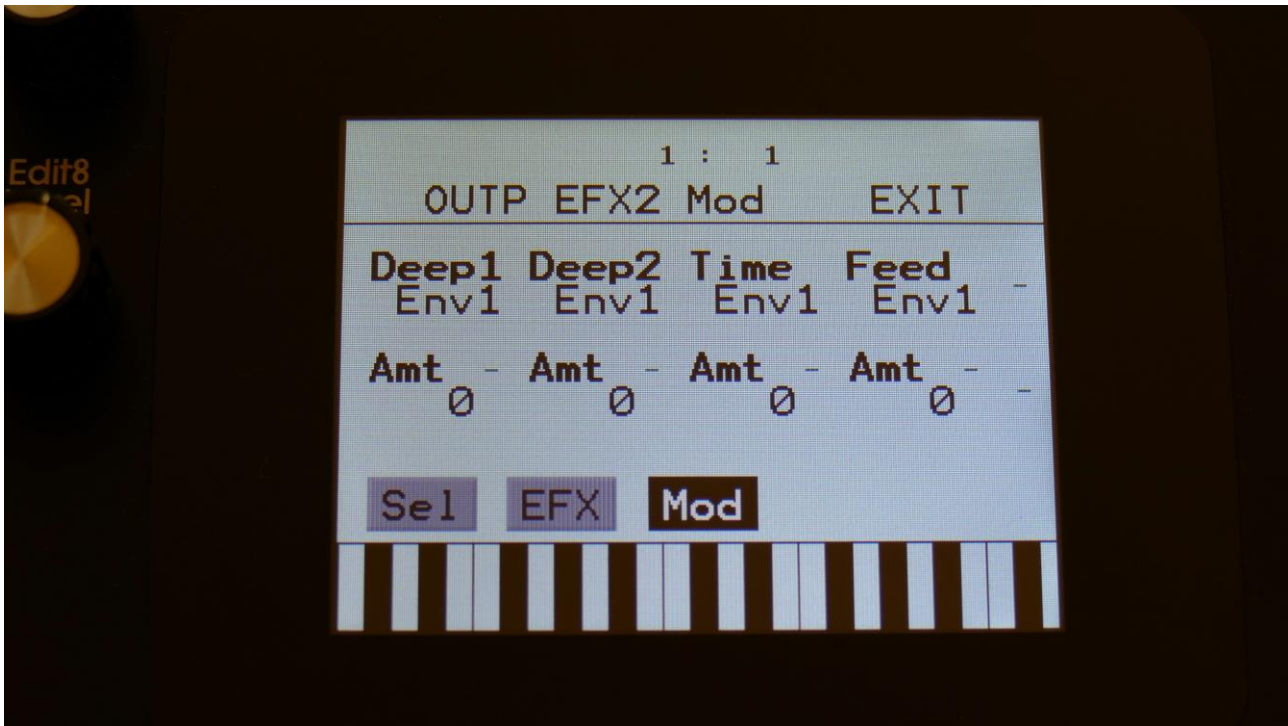

Touch the Mod touch button, to access this page.

The 2 VU-meters at the right of the screen, shows the Effect input and output. The small VU-meters next to the parameters, shows the activity of the selected modulation sources.

For each parameter, that can be modulated, it is possible to select a modulation source, and to adjust the modulation amount. Only the positive modulation sources, can be selected by the Edit Knobs. To make a modulation source negative, touch the modulation source parameter. For a complete list of modulation sources, see the list in the start of this section.

The upper row of parameters selects the modulation sources, **the lower row of parameters** (Labelled Amt) adjusts the modulation amount in the range 0 to 511.

The parameters on this page:

Deep1 and Deep2: Modulates the deep parameter.

Time: Modulates the delay time parameter.

Feed: Modulates the feed parameter.

Granulator SQ



Touch the EFX touch button, to access this page.

The 2 VU-meters at the right of the screen, shows the Effect input and output.

Efx: Off, on. When the effect is off, it is bypassed.

Mix: The mix between the un-effected signal on the effect input, and the effected signal on the effect output.

Step: Sets how many steps the granulator sequencers should go through, until they starts over again from step one. Range: 1 to 16.

Feed: Adjusts how much of the Granulator output signal should be fed back to its input.

Resolution: Adjusts the resolution of the sequencer track, that controls the granulator. The granulator only uses the controller values of the sequencer steps, so the controller track and the granulator can run in different resolutions.

Size: A granular parameter. The more this is turned up, the less space of each granulator step is used, causing the granulator to "stutter".

Seq: Selects which of the 16 sequencer controller tracks, the granulator should get its step values from. Each value selects a different portion of the granulator input, to be played back.

X: "X" intermodulation of the sound. Another Gotharman special 😊

Granulator SQ Modulation



Touch the Mod touch button, to access this page.

The 2 VU-meters at the right of the screen, shows the Effect input and output. The small VU-meters next to the parameters, shows the activity of the selected modulation sources.

For each parameter, that can be modulated, it is possible to select a modulation source, and to adjust the modulation amount. Only the positive modulation sources, can be selected by the Edit Knobs. To make a modulation source negative, touch the modulation source parameter. For a complete list of modulation sources, see the list in the start of this section.

The upper row of parameters selects the modulation sources, **the lower row of parameters** (Labelled Amt) adjusts the modulation amount in the range 0 to 511.

The parameters on this page:

Step1 and Step2: Modulates the number of steps parameter.

Feed: Modulates the feed parameter.

X: Modulates the “X” parameter.

Variator

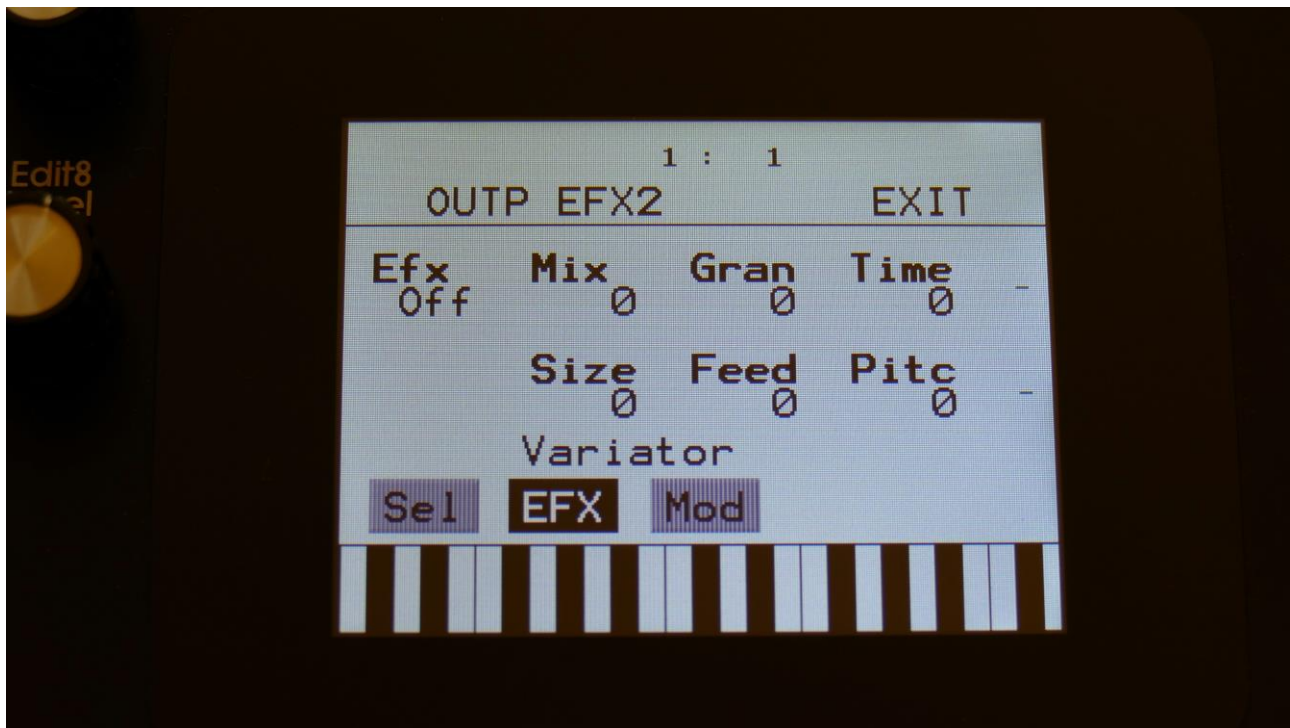

Touch the EFX touch button, to access this page.

The 2 VU-meters at the right of the screen, shows the Effect input and output.

Efx: Off, on, Freeze. When the effect is off, it is bypassed, and its input mixer can function as a mixer. When the effect are in Freeze mode, the input signal is no longer sampled. The sound that the effect holds, will just keep playing back on and on again. NOT ALL EFFECTS ARE AFFECTED BY FREEZE!

Mix: The mix between the un-effected signal on the effect input, and the effected signal on the effect output, that is sent to the audio bus.

Gran: Determines the variation pattern. Range: 0 to 511.

Time: The size of the RAM buffer used for the variator.

Size: The size of one grain.

Feed: Adjusts how much of the Variator output signal should be fed back to its input.

Pitc: The amount of Variator pitch shift.

Variator Modulation

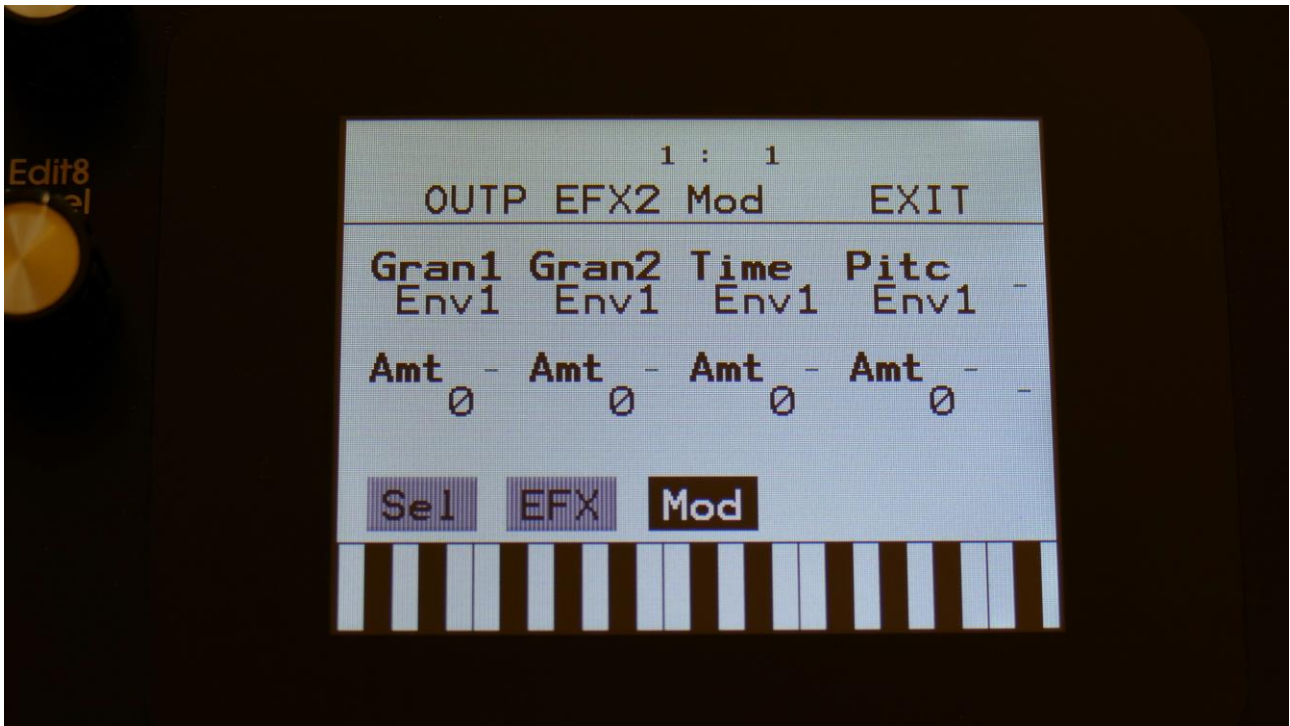

Touch the Mod touch button, to access this page.

The 2 VU-meters at the right of the screen, shows the Effect input and output. The small VU-meters next to the parameters, shows the activity of the selected modulation sources.

For each parameter, that can be modulated, it is possible to select a modulation source, and to adjust the modulation amount. Only the positive modulation sources, can be selected by the Edit Knobs. To make a modulation source negative, touch the modulation source parameter. For a complete list of modulation sources, see the list in the start of this section.

The upper row of parameters selects the modulation sources, **the lower row of parameters** (Labelled Amt) adjusts the modulation amount in the range 0 to 511.

The parameters on this page:

Gran1 and Gran2: Modulates the gran variation pattern parameter.

Time: Modulates the time parameter.

Pitc: Modulates the pitch shift parameter.

Reverb

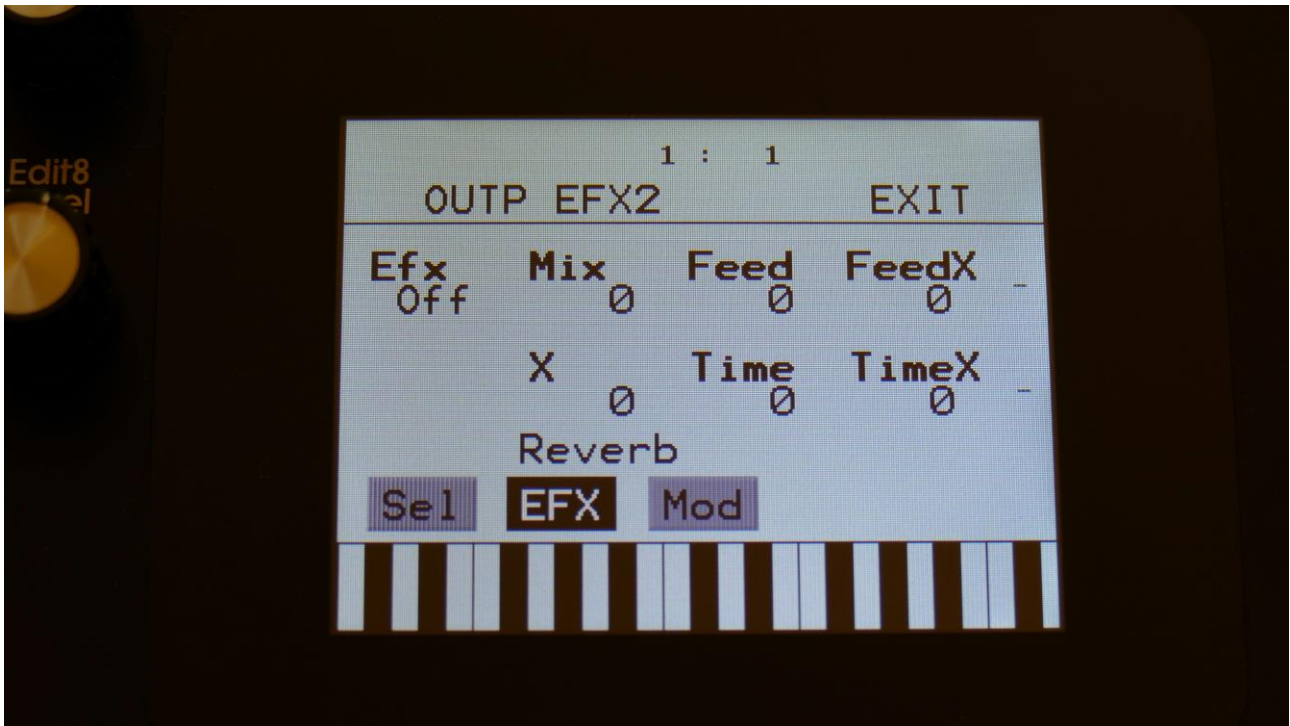

Touch the EFX touch button, to access this page.

The 2 VU-meters at the right of the screen, shows the Effect input and output.

Efx: Off, on. When the effect is off, it is bypassed.

Mix: The mix between the un-effected signal on the effect input, and the effected signal on the effect output.

Feed: Reverb feedback.

Feed X: Adjusts how much the following reverb taps will decrease in feedback. Lower settings gives a delay effect. As this is turned up, it goes over in a metallic reverb type, and at higher settings it gives a more full reverb.

X: "X" intermodulation of the sound. Another Gotharman special ☺

Time: Reverb time. The total reverb time is a combination of time, timeX, feed and feedX.

Time X: Adjusts how much the following reverb taps will decrease in time. Lower settings is good for a short reverb, and higher settings for a long reverb.

Reverb Modulation

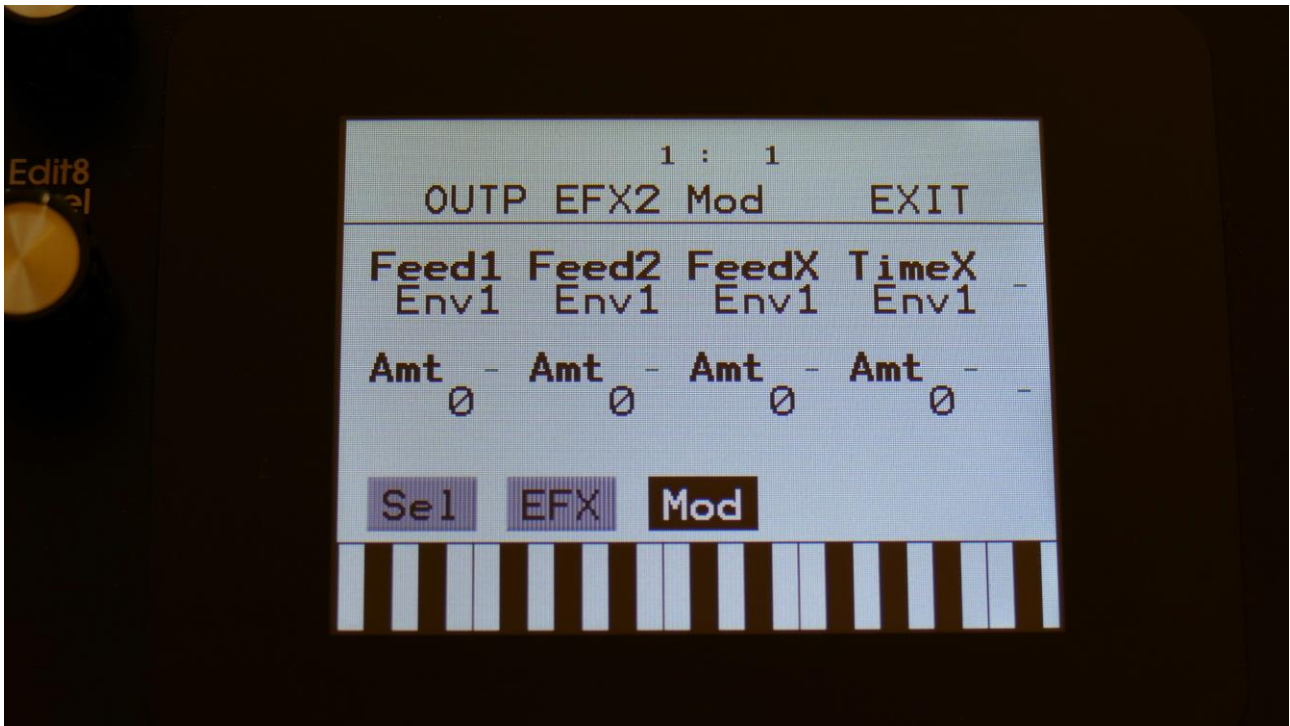

Touch the Mod touch button, to access this page.

The 2 VU-meters at the right of the screen, shows the Effect input and output. The small VU-meters next to the parameters, shows the activity of the selected modulation sources.

For each parameter, that can be modulated, it is possible to select a modulation source, and to adjust the modulation amount. Only the positive modulation sources, can be selected by the Edit Knobs. To make a modulation source negative, touch the modulation source parameter. For a complete list of modulation sources, see the list in the start of this section.

The upper row of parameters selects the modulation sources, **the lower row of parameters** (Labelled Amt) adjusts the modulation amount in the range 0 to 511.

The parameters on this page:

Feed1 and Feed2: Modulates the feedback parameter.

FeedX: Modulates the feed x parameter.

TimeX: Modulates the time x parameter.

Granulator (unsynced)

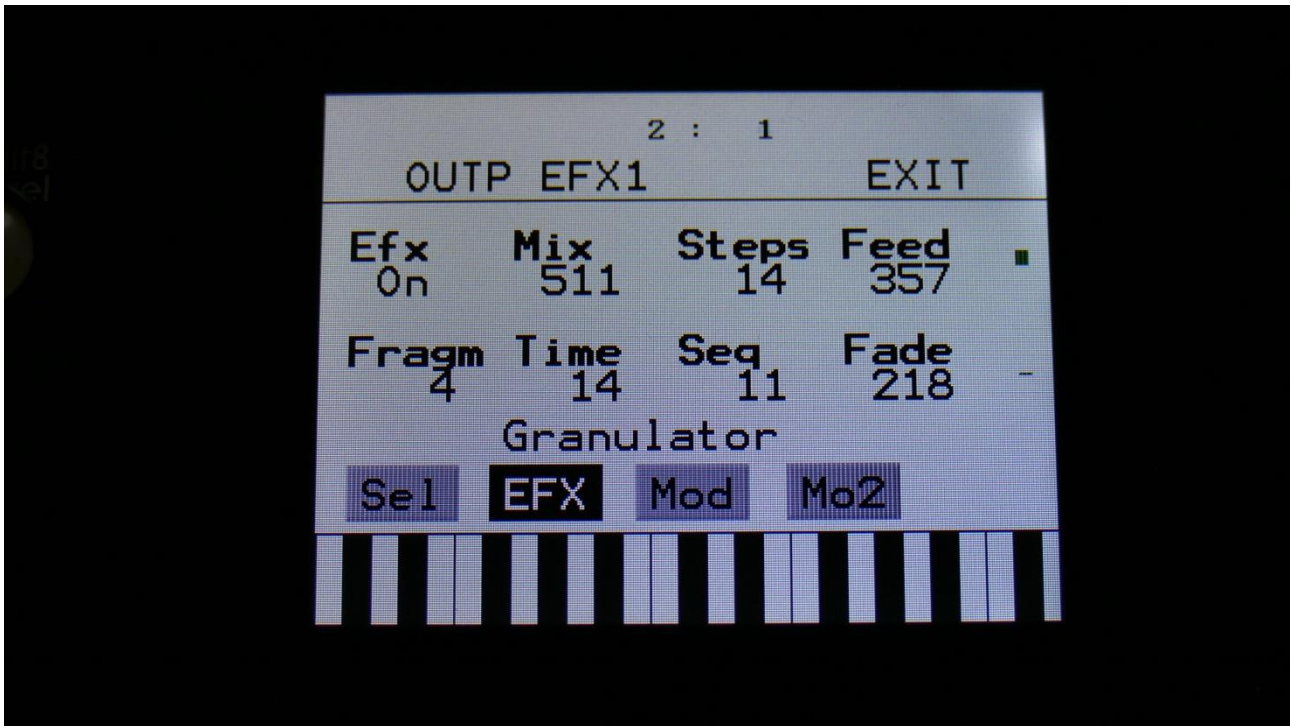

Touch the EFX touch button, to access this page.

The 2 VU-meters at the right of the screen, shows the Effect input and output.

Efx: Off, on. When the effect is off, it is bypassed.

Mix: The mix between the un-effected signal on the effect input, and the effected signal on the effect output.

Steps: Sets how many steps the granulator sequences should go through, until they starts over again from step one. Range: 1 to 16.

Feed: Adjusts how much of the Granulator output signal should be fed back to its input.

Fragn: Sets how many fragments (or grains) the input signal should be cutted up in. Possible values are 1, 2, 4, 8, 16, 32, 64 or 128.

Time: Sets the size of the input recording buffer. The higher the size, the bigger each grain will be.

Seq: Selects which of the 16 sequencer controller tracks, the granulator should get it step values from. Each value selects a different portion of the granulator input, to be played back.

Fade: When this parameter is turned up, each grain will fade in and out, to minimize clicks.

Granulator Modulation

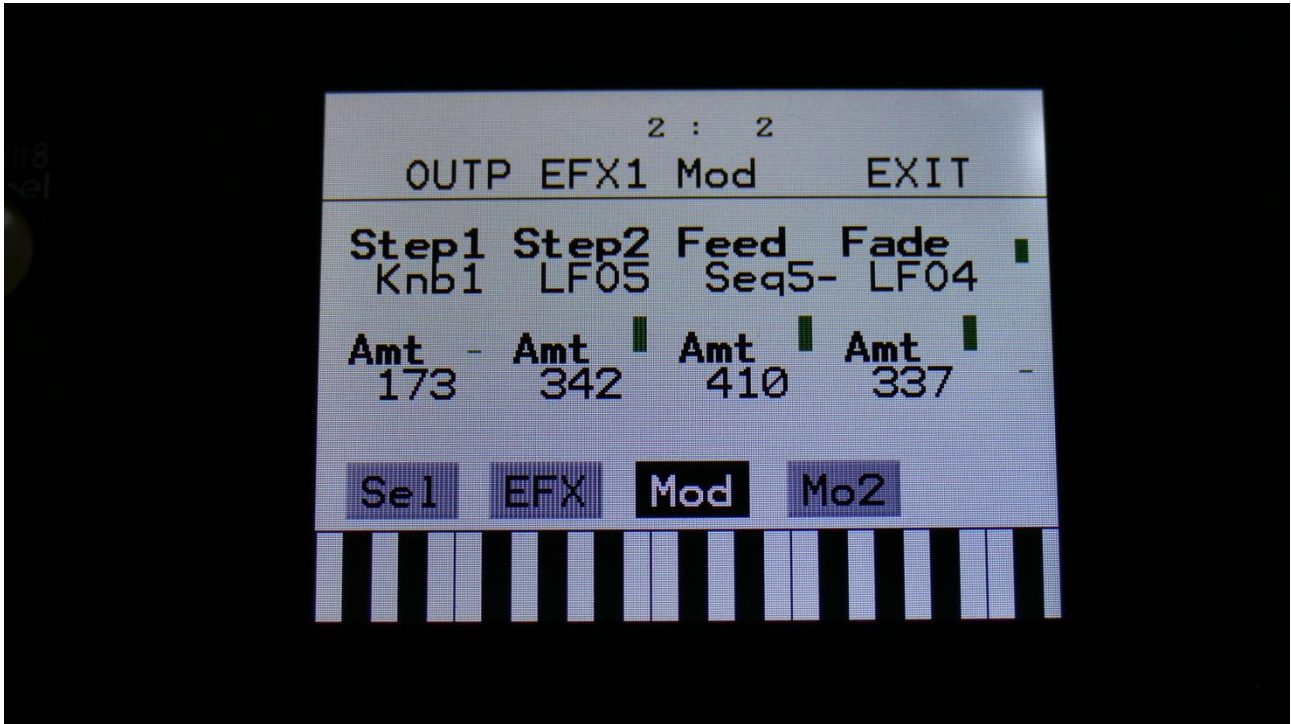

Touch the Mod touch button, to access this page.

The 2 VU-meters at the right of the screen, shows the Effect input and output. The small VU-meters next to the parameters, shows the activity of the selected modulation sources.

For each parameter, that can be modulated, it is possible to select a modulation source, and to adjust the modulation amount. Only the positive modulation sources, can be selected by the Edit Knobs. To make a modulation source negative, touch the modulation source parameter. For a complete list of modulation sources, see the list in the start of this section.

The upper row of parameters selects the modulation sources, **the lower row of parameters** (Labelled Amt) adjusts the modulation amount in the range 0 to 511.

The parameters on this page:

Step1 and Step2: Modulates the number of steps parameter.

Feed: Modulates the feed parameter.

Fade: Modulates the Fade in and out times.

Xfade Granulator

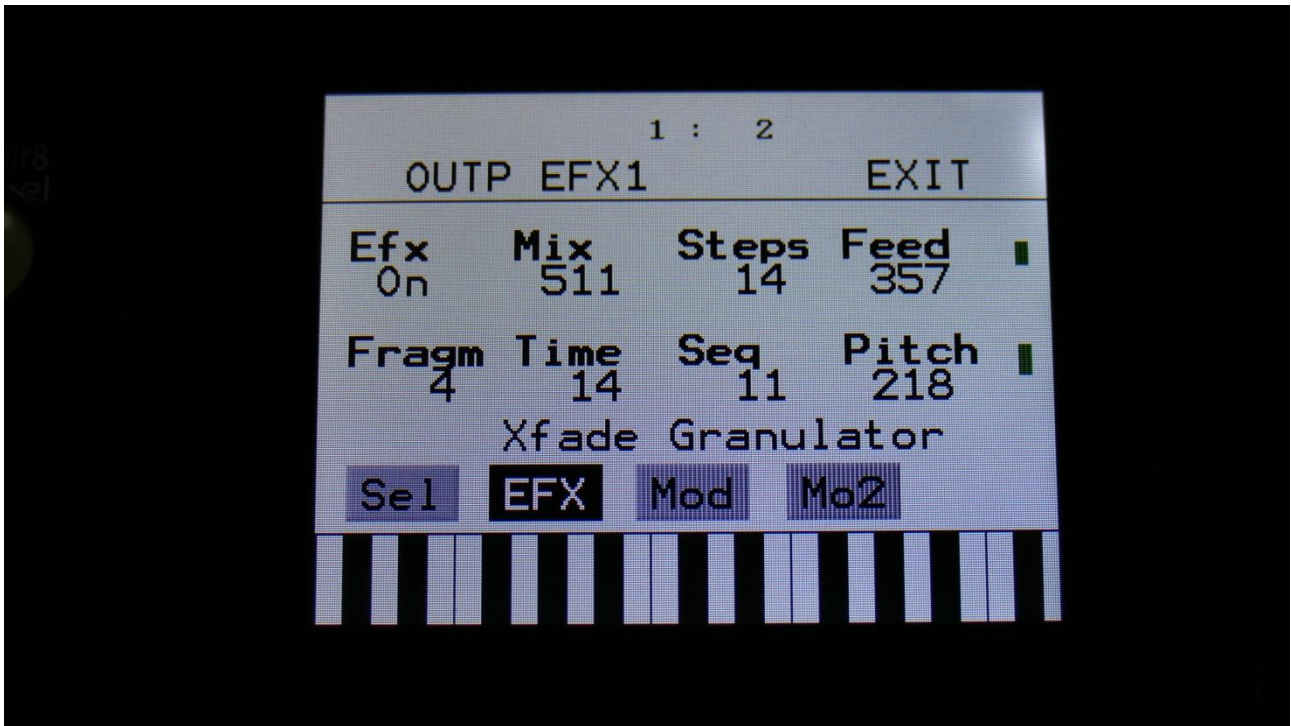

Touch the EFX touch button, to access this page.

The 2 VU-meters at the right of the screen, shows the Effect input and output.

Efx: Off, on. When the effect is off, it is bypassed.

Mix: The mix between the un-effected signal on the effect input, and the effected signal on the effect output.

Steps: Sets how many steps the granulator sequences should go through, until they starts over again from step one. Range: 1 to 16.

Feed: Adjusts how much of the Granulator output signal should be fed back to its input.

Fragn: Sets how many fragments (or grains) the input signal should be cutted up in. Possible values are 1, 2, 4, 8, 16, 32, 64 or 128.

Time: Sets the size of the input recording buffer. The higher the size, the bigger each grain will be.

Seq: Selects which of the 16 sequencer controller tracks, the granulator should get it step values from. Each value selects a different portion of the granulator input, to be played back.

Pitch: Sets the playback pitch of the granular sequence. A value below 256 will pitch the signal down, a value above 256 will pitch it up.

Xfade Granulator Modulation

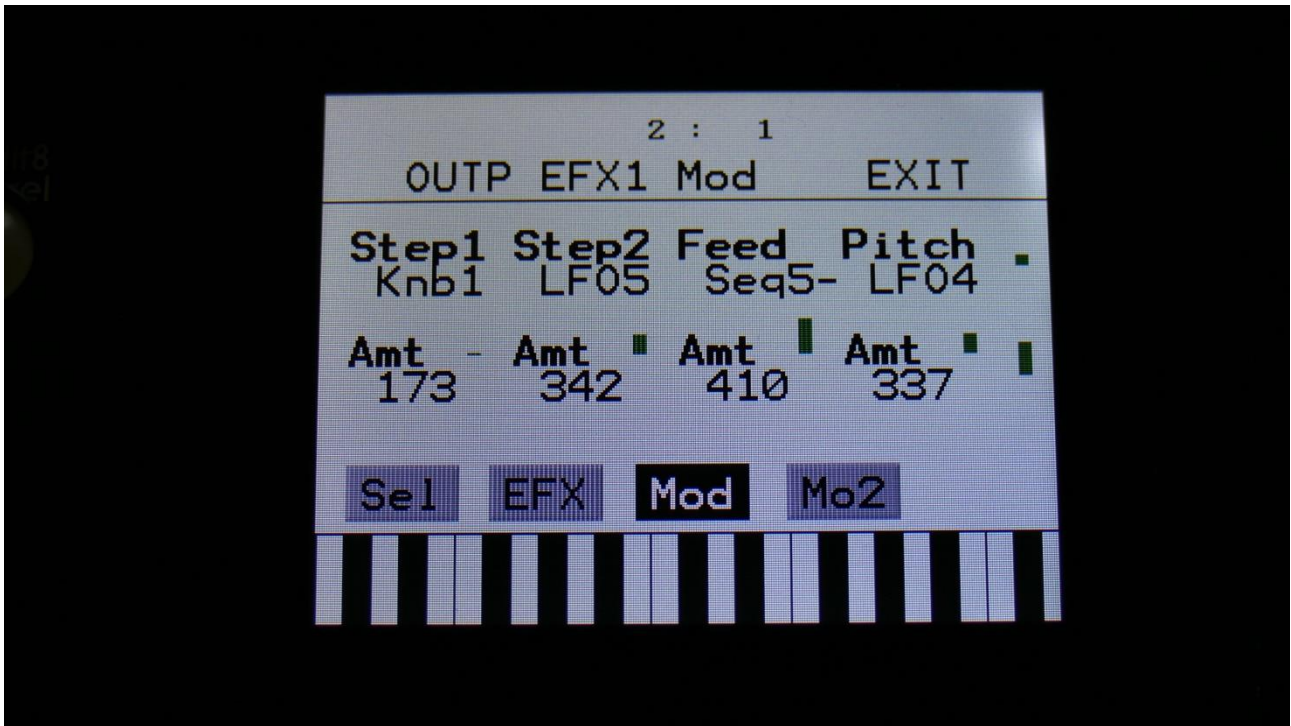

Touch the Mod touch button, to access this page.

The 2 VU-meters at the right of the screen, shows the Effect input and output. The small VU-meters next to the parameters, shows the activity of the selected modulation sources.

For each parameter, that can be modulated, it is possible to select a modulation source, and to adjust the modulation amount. Only the positive modulation sources, can be selected by the Edit Knobs. To make a modulation source negative, touch the modulation source parameter. For a complete list of modulation sources, see the list in the start of this section.

The upper row of parameters selects the modulation sources, **the lower row of parameters** (Labelled Amt) adjusts the modulation amount in the range 0 to 511.

The parameters on this page:

Step1 and Step2: Modulates the number of steps parameter.

Feed: Modulates the feed parameter.

Pitch: Modulates the pitch of the granular sequence.

Abstract0



Touch the EFX touch button, to access this page.

The 2 VU-meters at the right of the screen, shows the Effect input and output.

Efx: Off, on. When the effect is off, it is bypassed.

Mix: The mix between the un-effected signal on the effect input, and the effected signal on the effect output.

Play1, Play2: 0 (Off), 1 to 511. Sets for how long time each of the playback heads should play back, until it jumps to a new random location.

Rec: 0 to 511. Sets the record buffer size. Determines for how long time it should record the input, before it starts over again.

Psize: 0 (Off), 1 to 255. This parameter sets the total playback buffer size, independent of the record buffer size. If this parameter is 0, the Rec parameter determines the playback buffer size, but if it is at any other value, this parameter determines the playback buffer size. It can be used as a fast way of adjusting the playback length of both playback heads at the same time. At low settings, granular effects with very small grains can be obtained. If the value of this is higher than

the Rec parameter, it will play back areas of the record buffer, that is not being recorded, and create a "Freeze" effect.

Pitc2: 0 to 511. Sets the pitch of the playback for playhead 2. A value below 256 will pitch the signal down, a value above 256 will pitch it up.

Abstract0 Modulation



Touch the Mod touch button, to access this page.

The 2 VU-meters at the right of the screen, shows the Effect input and output. The small VU-meters next to the parameters, shows the activity of the selected modulation sources.

For each parameter, that can be modulated, it is possible to select a modulation source, and to adjust the modulation amount. Only the positive modulation sources, can be selected by the Edit Knobs. To make a modulation source negative, touch the modulation source parameter. For a complete list of modulation sources, see the list in the start of this section.

The upper row of parameters selects the modulation sources, **the lower row of parameters** (Labelled Amt) adjusts the modulation amount in the range 0 to 511.

The parameters on this page:

Play1: Modulates the size of playback head 1.

Play2: Modulates the size of playback head 2.

Pitc2: Modulates the pitch of playback head 2.

Time Stretch

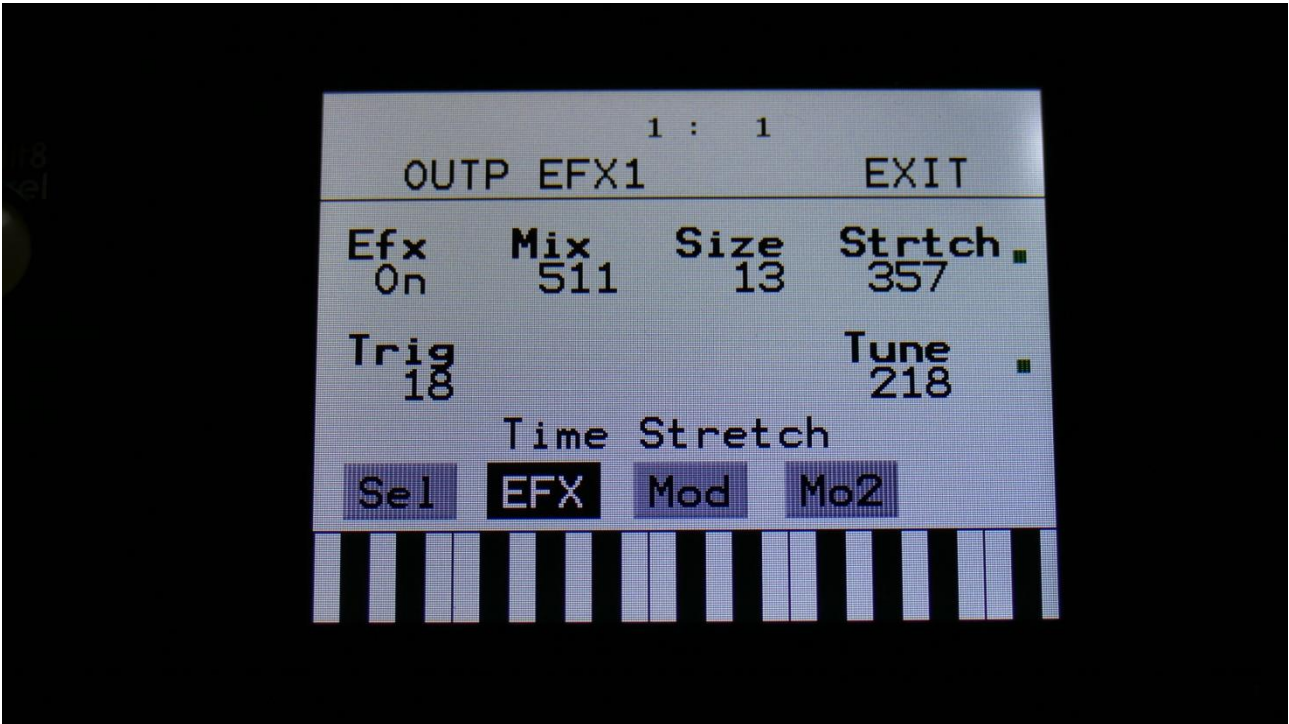

Touch the EFX touch button, to access this page.

The 2 VU-meters at the right of the screen, shows the Effect input and output.

Efx: Off, on. When the effect is off, it is bypassed.

Mix: The mix between the un-effected signal on the effect input, and the effected signal on the effect output.

Size: 0 to 511. The size of the RAM buffer used for the TimeStretcher.

Strtch: 0 to 511. Time stretch. A value below 256 will stretch the sound longer, a value above 256 will compress the sound to become shorter.

Trig: Off, 1 to 16. Determines if the time stretch effect should be triggered by a part or not.

Tune: Pitch Coarse. A value below 256 will pitch the signal down, a value above 256 will pitch it up.

Time Stretch Modulation

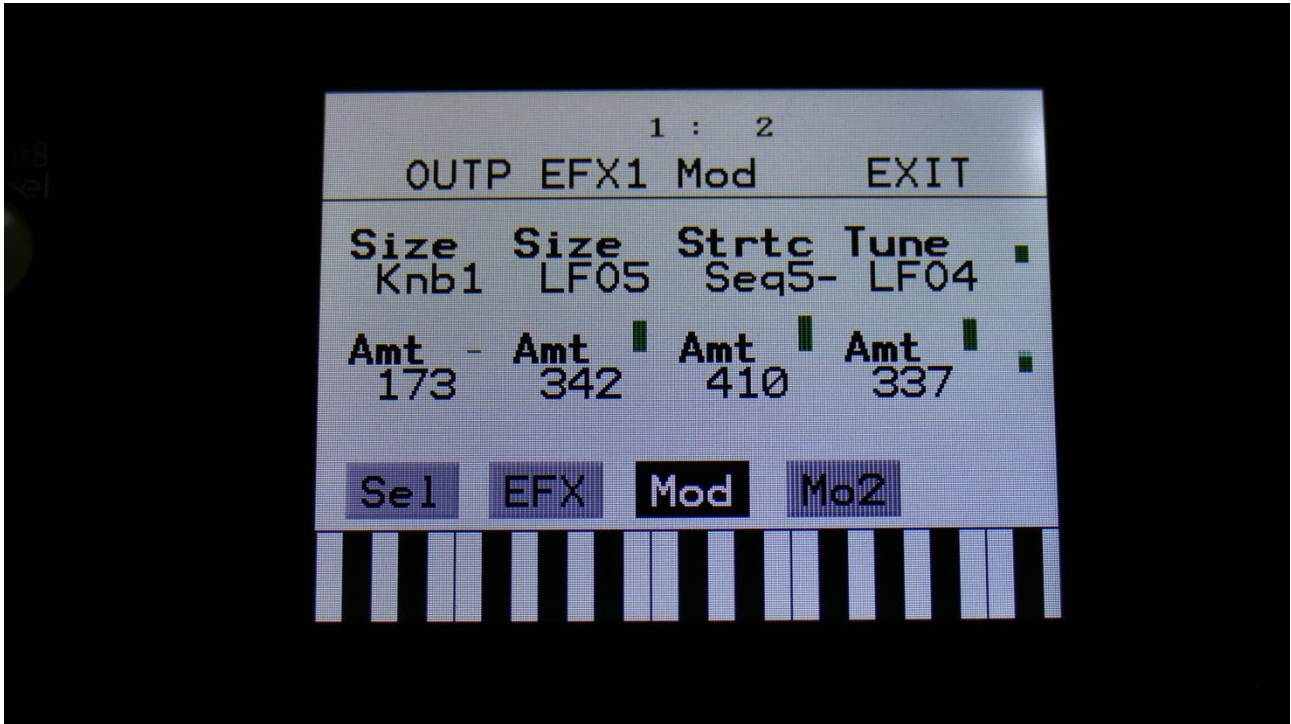

Touch the Mod touch button, to access this page.

The 2 VU-meters at the right of the screen, shows the Effect input and output. The small VU-meters next to the parameters, shows the activity of the selected modulation sources.

For each parameter, that can be modulated, it is possible to select a modulation source, and to adjust the modulation amount. Only the positive modulation sources, can be selected by the Edit Knobs. To make a modulation source negative, touch the modulation source parameter. For a complete list of modulation sources, see the list in the start of this section.

The upper row of parameters selects the modulation sources, **the lower row of parameters** (Labelled Amt) adjusts the modulation amount in the range 0 to 511.

The parameters on this page:

Size: Modulates the size of the time stretch input buffer.

Strtc: Modulates the time stretching.

Tune: Modulates the pitch coarse.

Sample Pitch

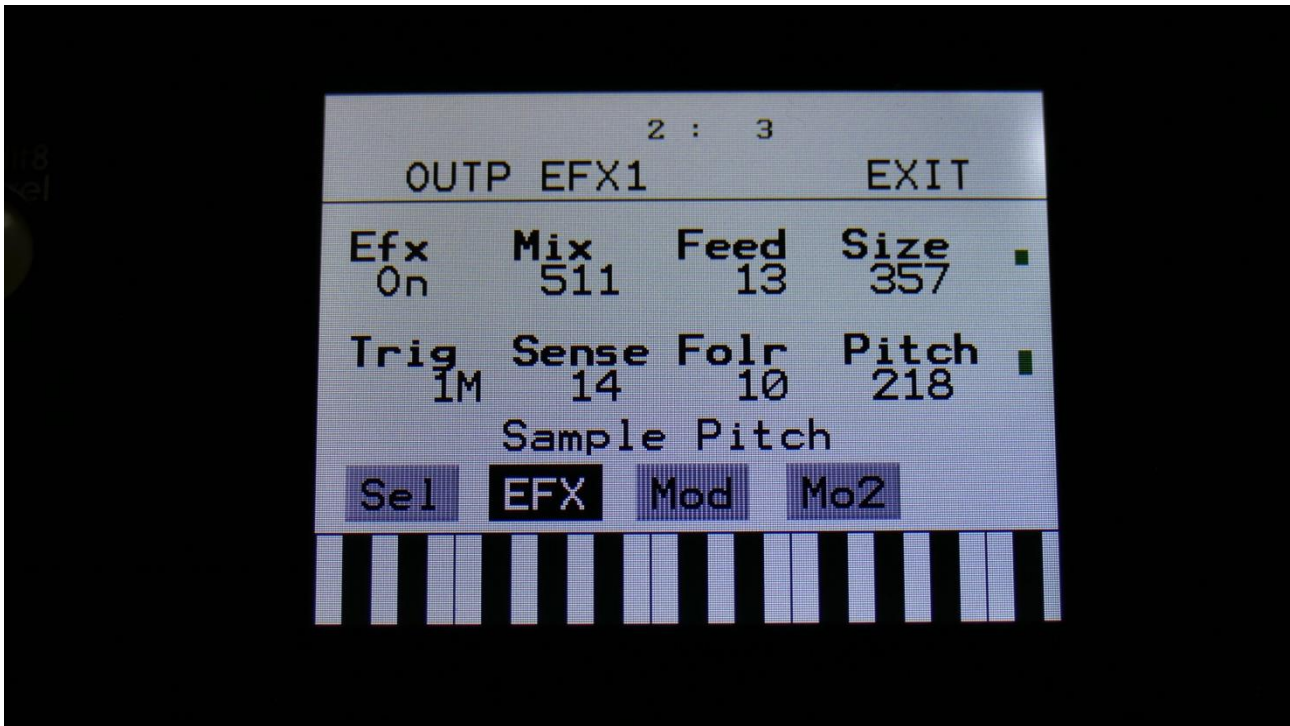

Touch the EFX touch button, to access this page.

The 2 VU-meters at the right of the screen, shows the Effect input and output.

Efx: Off, on. When the effect is off, it is bypassed.

Mix: The mix between the un-effected signal on the effect input, and the effected signal on the effect output.

Feed: Sets how much of the effect output signal should be fed back to its input.

Size: 0 to 511. The number of wave frames used for each pitch grain.

Trig: Off, 1 to 16, OffM, 1M to 16M. Determines if the sample pitch effect should be triggered by all parts or a single part. The “M” suffix indicates that the playback pointer will be moving in another pattern, that will give slightly different results.

Folr: The sample pitch effect output envelope follower rate.

Pitch: The playback pitch. Values below 256 will tune down, values above 256 will tune up.

Sample Pitch Modulation

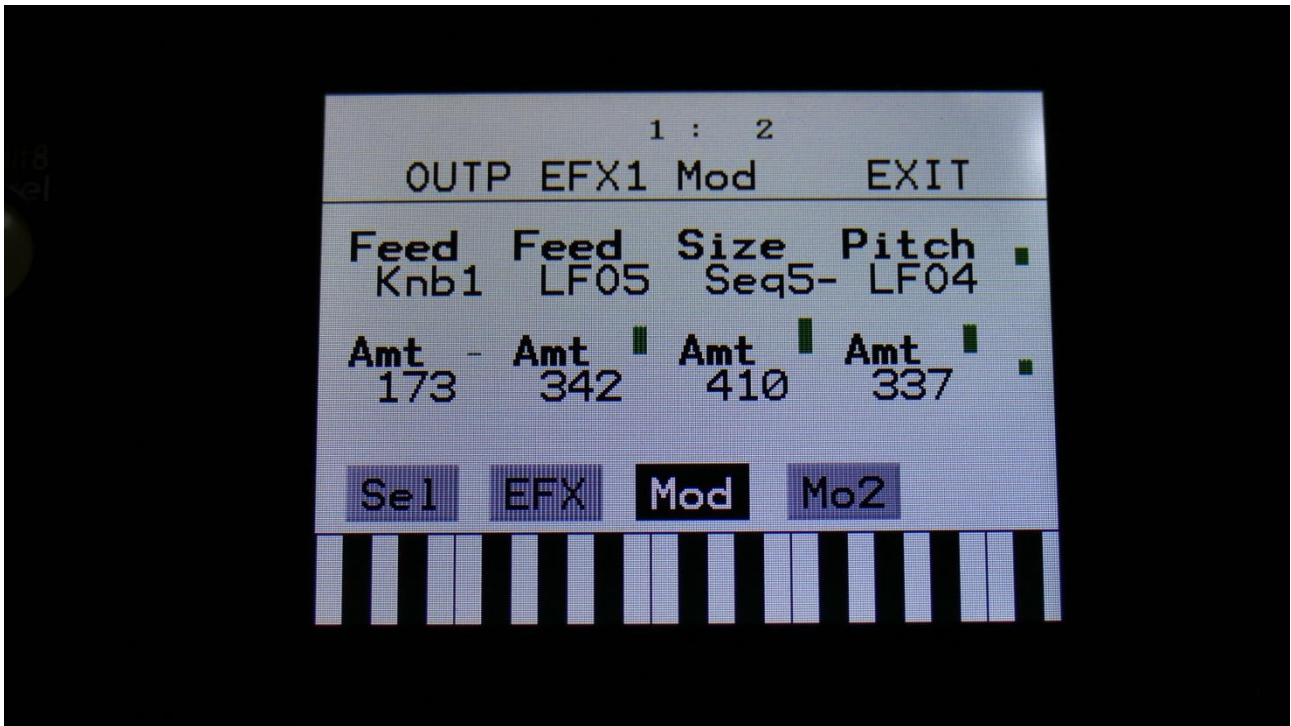

Touch the Mod touch button, to access this page.

The 2 VU-meters at the right of the screen, shows the Effect input and output. The small VU-meters next to the parameters, shows the activity of the selected modulation sources.

For each parameter, that can be modulated, it is possible to select a modulation source, and to adjust the modulation amount. Only the positive modulation sources, can be selected by the Edit Knobs. To make a modulation source negative, touch the modulation source parameter. For a complete list of modulation sources, see the list in the start of this section.

The upper row of parameters selects the modulation sources, **the lower row of parameters** (Labelled Amt) adjusts the modulation amount in the range 0 to 511.

The parameters on this page:

Feed: Modulates the feed parameter.

Size: Modulates the number of waveframes, used for the pitch shifting.

Pitch: Modulates the pitch shifting.

The Sequencer

The LD3 sequencer has 2 different types of tracks: Note tracks and controller tracks. It has 16 note tracks and 32 controller tracks.

Each note track controls 1 part – Note track 1 controls part 1, note track 2 controls part 2 and so on, and each track has a note number subtrack, a gate time subtrack, a velocity subtrack, a position subtrack, a sub-position subtrack and a step on/off subtrack. Note number, gate time, delay time, swing, velocity and position can be modulated. All 16 note tracks can either control an internal part, or an external MIDI device. Each note track can be up to 64 steps long, and the resolution can be set from 1/64 to 1/2. Each step of a note track, can play back at any position of the sequence, allowing polyphonic step sequencing. A Strum parameter has also been added, to make polyphonic chords strum.

A scale can be added on the output of a note track. This can be a harmonic scale, or a scale that swaps the keys of an octave, or a scale that swaps the black and the white keys.

Each controller track outputs their value to the modulation sources matrix and, if selected, to MIDI out (CC's and PitchBend). They can be up to 128 steps long, and resolution can be set from 1/64 to 1/2. A smooth parameter are available, that when on, will make a controller track slide from one step to the next.

Templates are available, like ramp up, ramp down and randomize. The percentage of how much the template should affect the track is settable.

The position track has special templates for forwards, backwards, alternating, random, 2 note and 4 note sequences.

All tracks has separate last step, start step and resolution settings, so even polyrhythmic sequences are possible.

The tempo of the sequencer can be set between 51 and 306 BPM. It can sync to MIDI clock, and it is both possible to transmit and re-send MIDI clock to MIDI out.

Inputting of note number values can be done in analog/TR fashion, via the step buttons, and it can be done by realtime recording, either monophonic or polyphonic, and by step recording, either monophonic or polyphonic. To assist the realtime recording, a metronome is present. It is also possible to record samplings as audio tracks via the sequencer.

Inputting of controller track values can only be done via the touch screen, by realtime or step recording.

It is possible to mute and edit each track separately.

Remember to save all edits you do in the sequencer. Else they will be lost when you change preset, or turn LD3 off. See how to in the "Save Preset" section.

Starting and stopping the Sequencer:

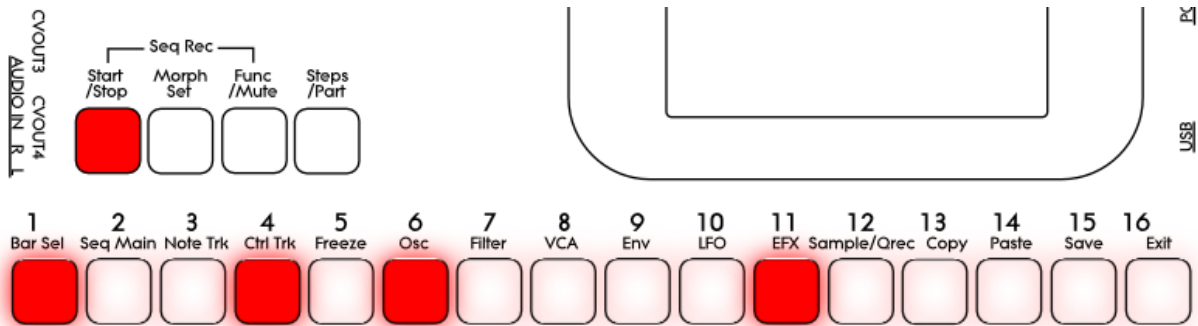

To start the sequencer playback, push and release the Start/Stop button, so that it lights up.

The sequencer will now start to play back. When the Func/Mute and the Steps/part buttons are not lighting up, every time a part is triggered to play back, the corresponding step button will light up shortly.

To stop the sequencer, simply hit the Start/Stop button again, so that it is no longer lighting up.

If you hit the play button to start the sequencer, and it doesn't start, please check in the "MOR>COMMON" section (described later in this manual), that it is not set up to external MIDI sync.

Selecting a track:

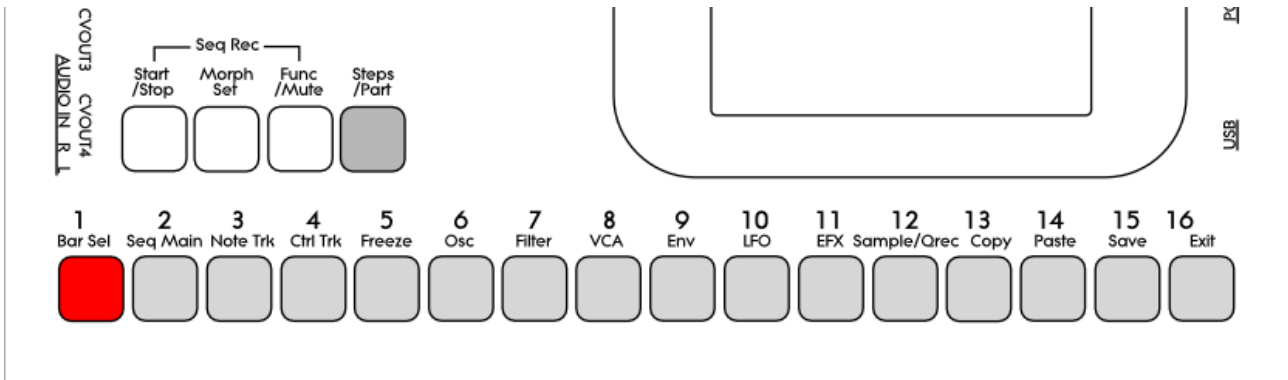

Push and hold the Steps/Part button.

The selected track number will now be shown, by one of the 16 step buttons lightning up. The number above the step button, is the track number that is currently selected.

To select another track, while still holding down the Steps/Part button, push any of the 16 step buttons.

The selected track, is the track which parameters will be shown on the display, when entering the edit pages.

When entering the Sequencer Controller tracks 17 to 32, 1 will equal 17, 2 will equal 18, and so on.

Note tracks are selected together with the part, while Controller tracks are selected separately.

Sequencer Note Track Steps view/edit:

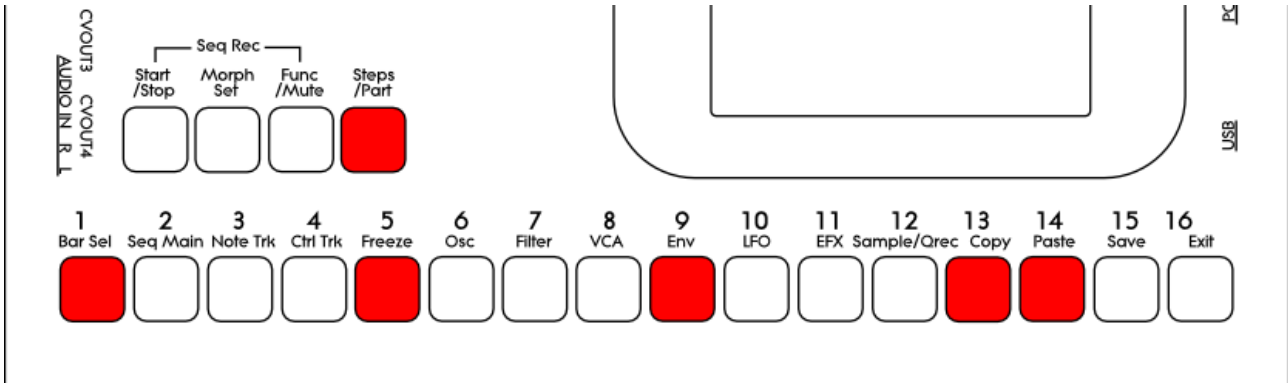

First, select the track, for which you would like to view/edit the note steps, as described earlier in this manual. You can, of course, select another track at any time, also after you have entered note step edit mode.

To enter note step edit mode, push and release the Steps/Part button. This should now light up. Any note sequencer steps that are switched on to play back, will now also light up on the 16 step buttons.

If the sequencer is running, the light state of each step button will be reversed, when a step is playing back.

To switch a step on or off, simply hit the corresponding step button, as it will toggle its state.

When the sequencer are in recording mode (the Start/Stop button is flashing), pushing any of the step buttons, will set record mode to step mode, and select this step for recording. The step button will now flash.

When using the LD3 sequencer as a usual step sequencer, the steps will play back from left to right. In this case, step 1 plays back at position 1, step 2 plays back at position 2 and so on. On the LD3 sequencer, it is though possible to break this pattern, and make each step play back on any position, using the position subtrack. It is even possible to make more steps playing back at the same position, for polyphonic step sequencing.

Only 16 steps are shown at a time. The note tracks of LD3 has 64 steps. Please read on, to experience how to switch between step 1-16, 17-32, 33-48 and 49-64.

Selecting Sequencer Note Track steps 1-16, 17-32, 33-48 and 49 to 64 / + Controller tracks steps 65-80, 81-96, 97-112, 113-128:

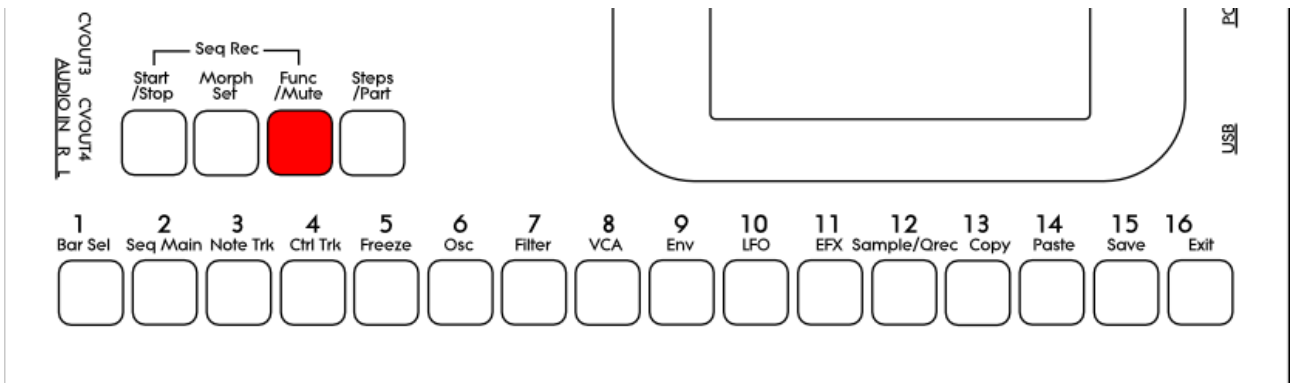

Push and release the **Func/Mute** button, so that it is lightning up. Now, push and release step button 1, **Bar Sel**:

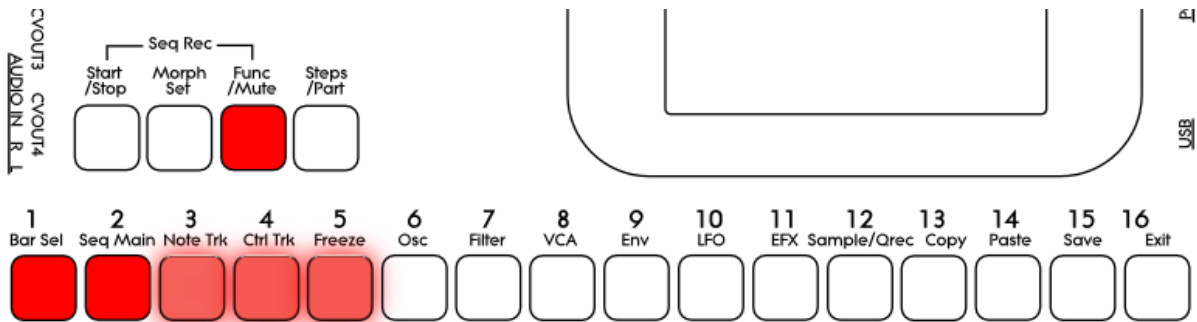

Now step button 1, **Bar Sel**, will light up.

Note tracks: When you are located on any other pages, than the sequencer controller tracks pages, bar is selected to be viewed for a note track. The selected bar, is the bar that is shown on the step buttons, and on the note track pages.

Hit Bar Sel, so that it lights up. Now step buttons 2 to 5 will select bar 1 to 4, of the currently selected track. The button of the bar that is selected, will light up. The other 3 bar select buttons will flash.

Controller tracks: When you are located on any of the controller track pages, bar is selected to be viewed for the currently selected controller track. The selected bar, is the bar that is shown on the controller track pages.

Hit Bar Sel, so that it lights up. Now step buttons 2 to 9 will select bar 1 to 8, of the currently selected track. The button of the bar that is selected, will light up. The other 7 bar select buttons will flash.

When pushing a bar button, that is already selected, both on note and controller tracks, the function of the Edit Knobs will now be toggled: Parameters > Knobs1-8 > Knobs 9-16.

Setting the last step of a Note Track

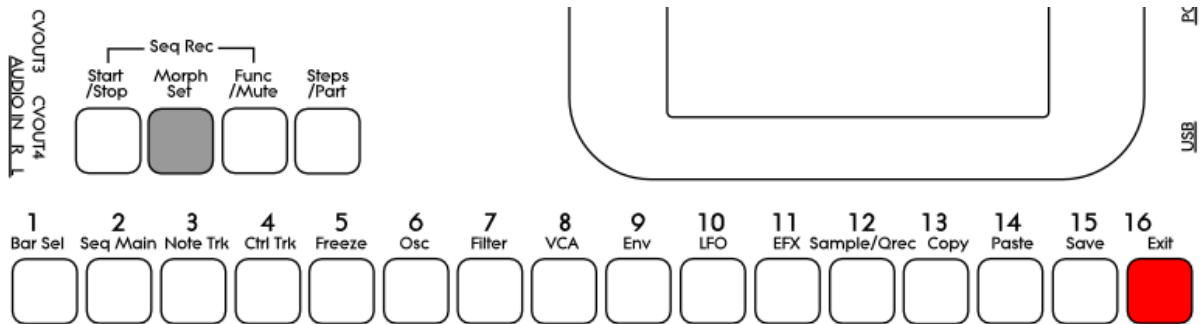

This can be done on the Note Tracks edit pages, but it can also be done via the pushbuttons.

Push and hold the Morph Set button. If the last step of the selected note track are inside the selected step range, this will now be shown, as a step button that lights up. Push any step button, while still holding down the Morph Set button, to set the last step of the selected Note Track.

Mute/Unmute Note Tracks:

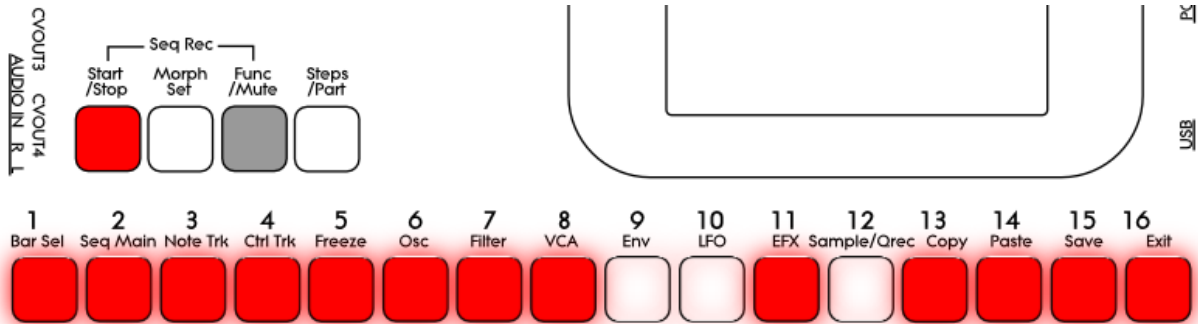

To mute, unmute or view the mute state of the 16 note tracks, push and hold the Func/Mute button.

Unmuted tracks will now be shown by a step button that is lighting up, and shortly flashes off, every time the track is triggering.

Muted tracks are shown by a step button that is unlit, and that lights up shortly, every time the track would have triggered something, if it weren't muted.

To mute or unmute a track, simply hit the corresponding step button, while still holding down the Func/Mute button.

Entering the Sequencer

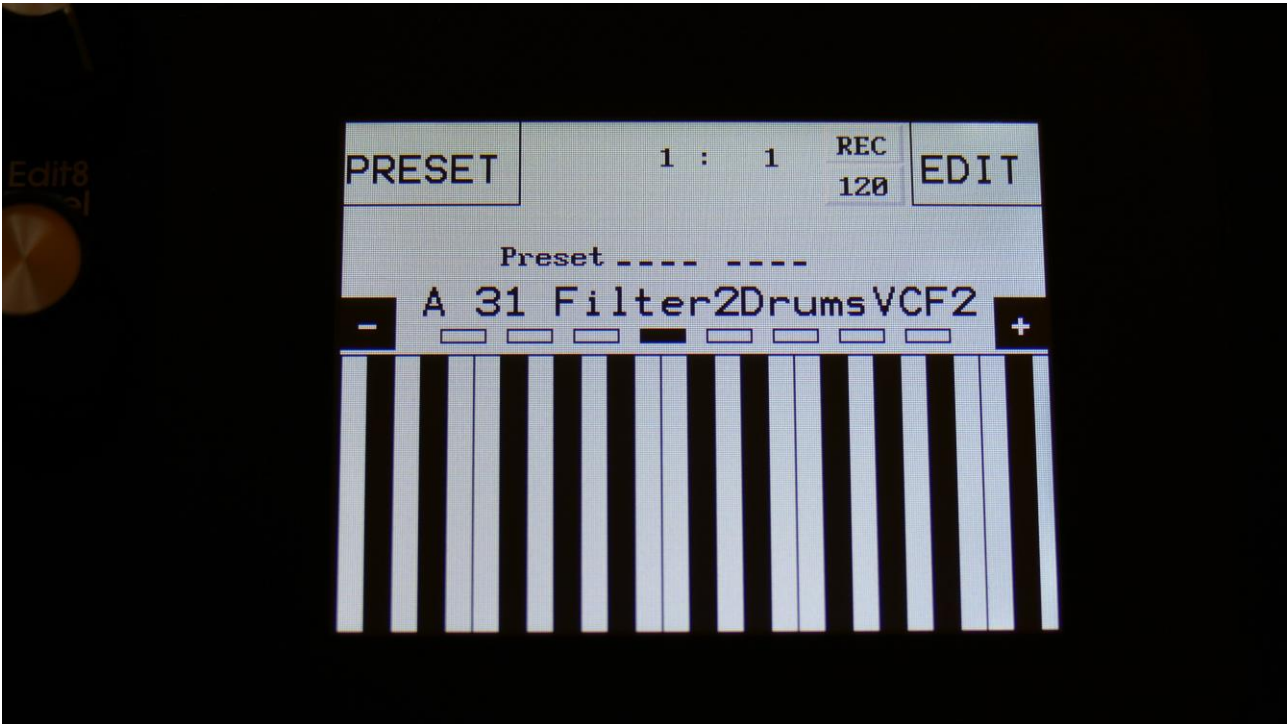

From the Preset Select Screen, touch the EDIT field.

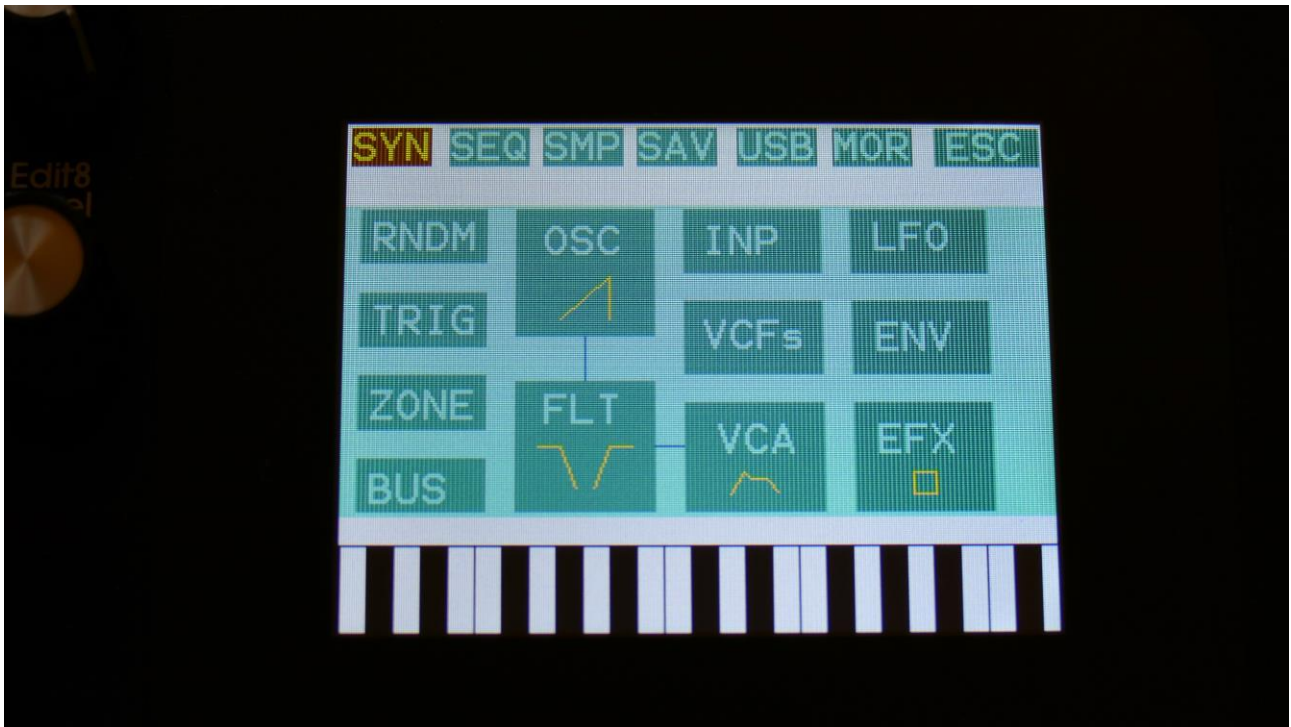

Touch SEQ on the navigation bar in the top of the screen.

This will bring you to the Sequencer access page:

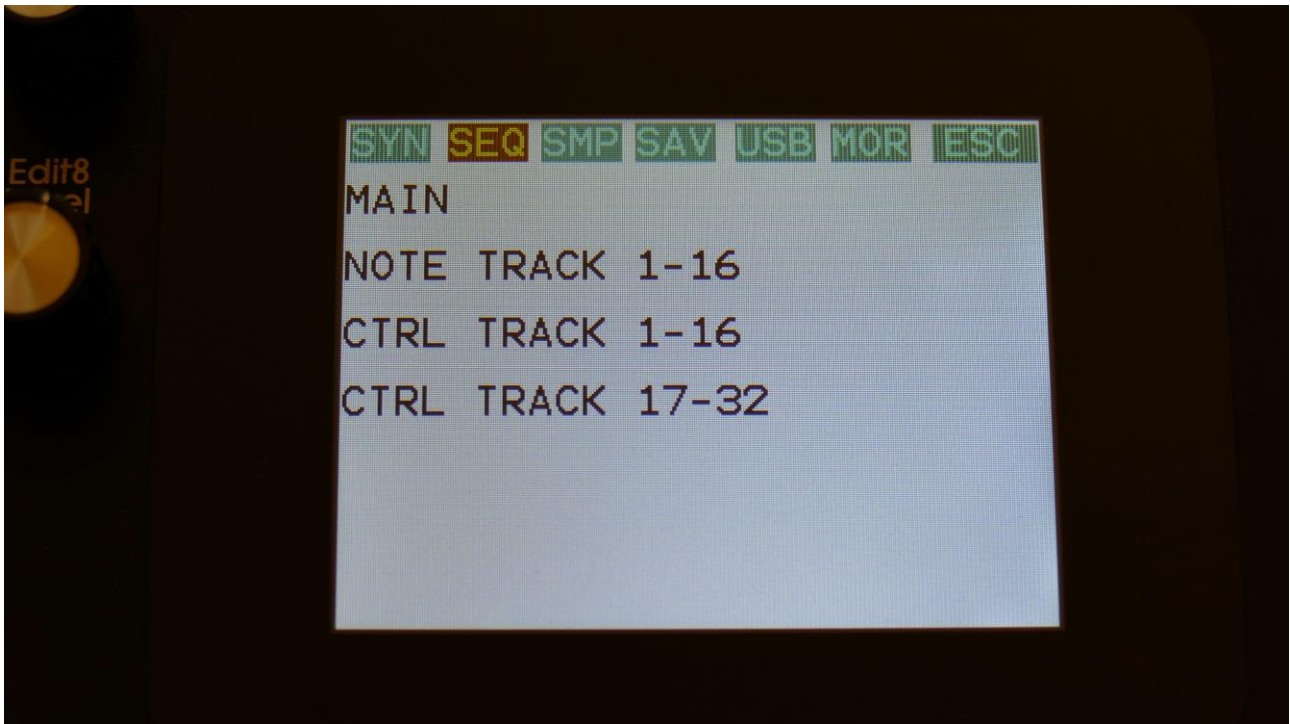

SEQ on the navigation bar has now changed its colour to brown/yellow, indicating that you have entered the Sequencer pages.

To enter the Sequencer Main page or any of the tracks, simply touch the text showing the name of the group that you would like to enter.

To exit to the Preset Select page, touch "ESC".

OR: Push and release the Func/Mute button, so that it lights up, and push step button 2/Seq Main, to access the Sequencer Main page.

Push step button 3/Note Trk to access the note track pages.

Push step button 4/Ctrl Trk to access the Controller Track pages. Push 3 times to access controller tracks 17-32.

Sequencer Main

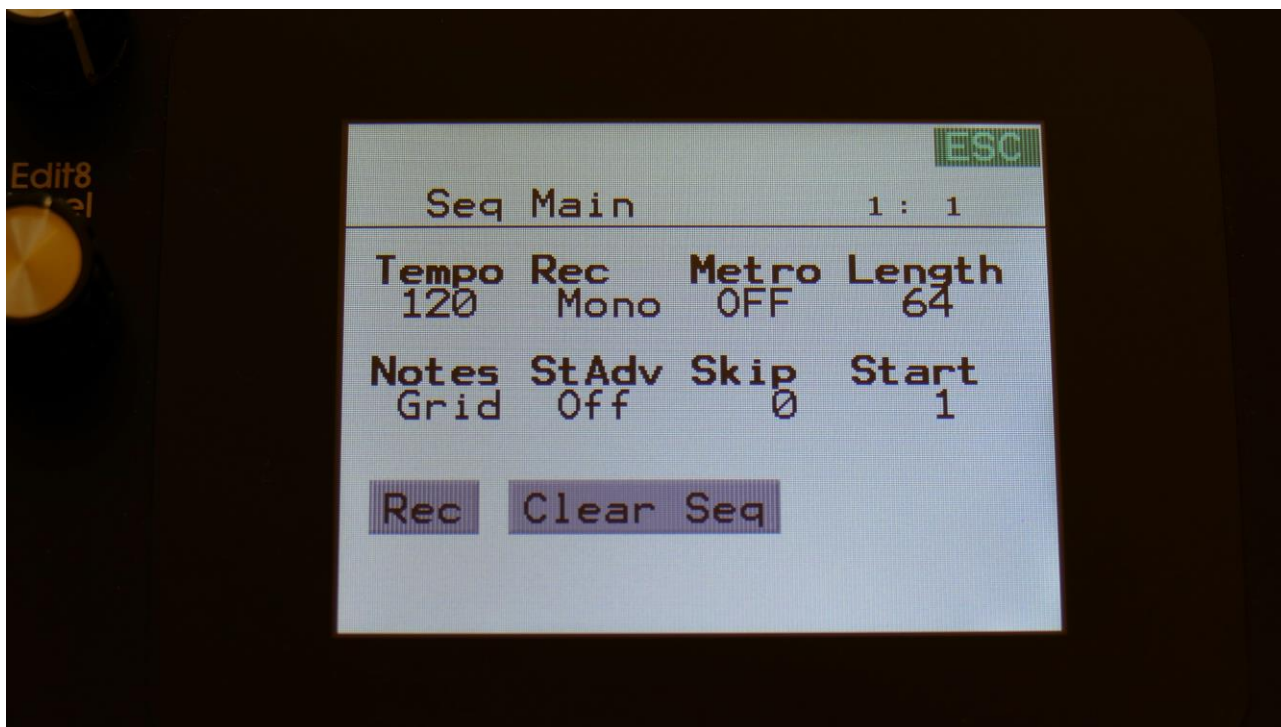

The parameters of this page:

Tempo: Sets the sequencer tempo between 1 and 256 BPM. To make the sequencer sync to external MIDI gear, this must be set up in the “MOR>COMMON” section, described later in this manual.

Rec: Note Tracks Realtime Record Mode. Can be:

-**Mono:** The note tracks are recorded monophonically, with one step per position. Each step is positioned in a linear fashion, with step 1 on position 1, step 2 on position 2 and so on...

-**Poly:** The note tracks are recorded polyphonically. The positions of the steps are programmed every time a note is received. If more notes are played at the same time, or at the same position in time, more steps will have the same position. Only steps that are off can be recorded. Each step gets positioned at the moment, that it is recorded. Step 1 is recorded first, and positioned to the position in time of the recorded note. Then step 2 is recorded and positioned. And so on...

-**Audio:** When sequencer recording is started, the sample recorder is also started. Audio is recorded from the selected tracks start point, to the selected tracks end point. When recording stops, a sample trigger is placed at step 1, to trigger the sampling, and the audio track will immediately start to play back. See the “Audio Tracks” section later in this manual.

-AudCH: Chopped audio track. When the audio track is recorded, chop points are inserted at each sequencer step, according to the resolution setting of the selected track. See the “Audio Tracks” section later in this manual.

Metro: Metronome Off, On, Rec.

-Off: The metronome is off, and will make no sound.

-On: The metronome is on, and when the sequencer is playing, it will put out a click to audio output 1, every time note track 1 passes a 4/4 beat. Every time note track 1 starts over, it will make a click that is slightly higher pitched than the other clicks.

-Rec: When the sequencer is playing, and realtime rec is activated, it will put out a click to audio output 1, every time note track 1 passes a 4/4 beat. Every time note track 1 starts over, it will make a click that is slightly higher pitched than the other clicks.

Length: Global tracks length. Sets the step length for all the 4 Note tracks and 8 Controller tracks equal with one parameter. From 1 to 64 steps. Track lengths can be set individually for each track, in the separate track menu’s.

Notes: Sets if the notes of the Note tracks should be shown in a note grid (setting: Grid), or as value bars (setting: Value). This can also be switched on the note track pages.

StAdv: Step Advance on/off. When step recording a sequence, it will automatically advance to the next step of the selected track, if this is set to on.

Skip: Turning this up, will cause the sequencer to randomly skip some beats here and there. The more it is turned up, the more it will skip.
This affects all sequencer tracks at the same time.

Start: Global tracks start step. Sets the start step for all the 4 Note tracks and the 8 Controller tracks equal with one parameter. From step 1 (default) to step 64. Track steps can be set individually for each track, in the separate track menu’s.

The buttons of this page:

Rec: This will toggle **realtime recording** on and off. **Realtime recording** can be switched on and off at any time, regardless of if the sequencer is playing or not. The sequencer must though play, to make it possible to input notes in realtime.

See “Realtime recording of notes” later in this section.

Clear Seq:

Touching this button, will make LD3 jump to this page:

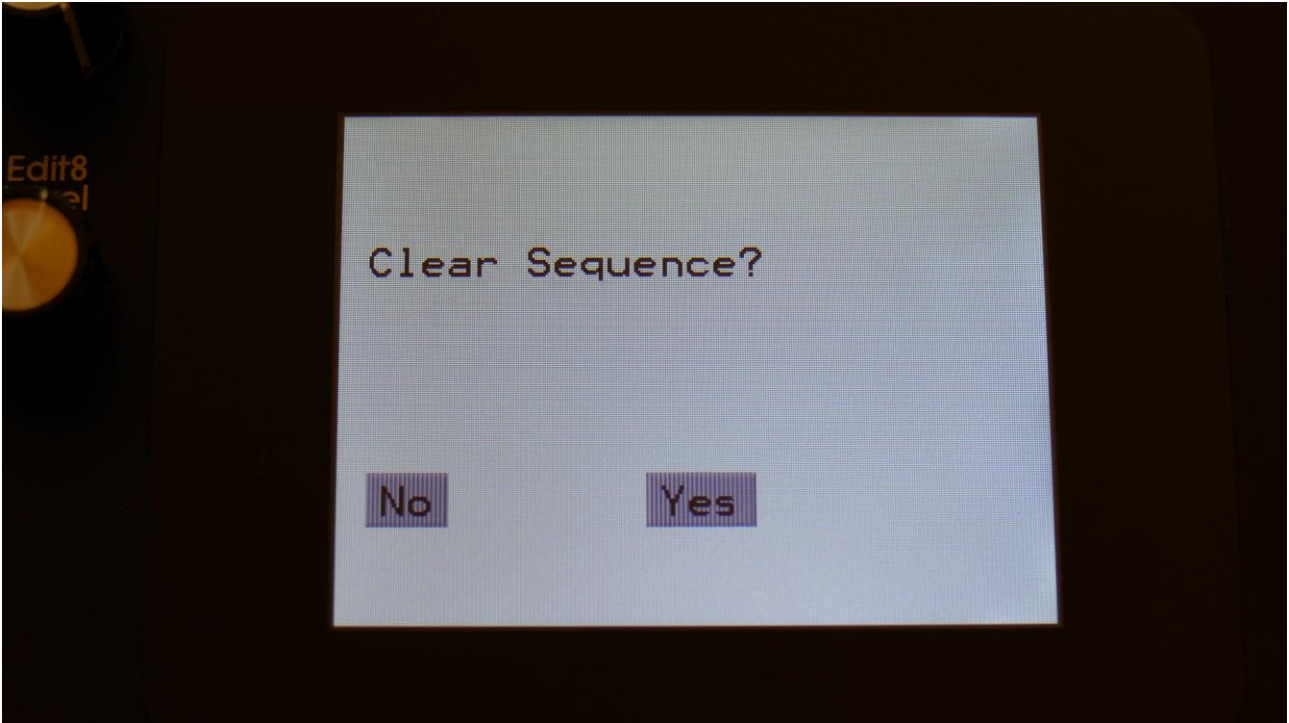

If you touch the “Yes” button here, you will clear all tracks of the current preset, and reset all values.

If you do not wish to do that, touch “No”.

Note Tracks

Note Subtrack

From the sequencer access page, touch NOTE TRACK 1-16, to enter the note steps edit page. OR: Push and release the Func/Mute button, so that it lights up, and push step button 3/Note Trk 1 time.

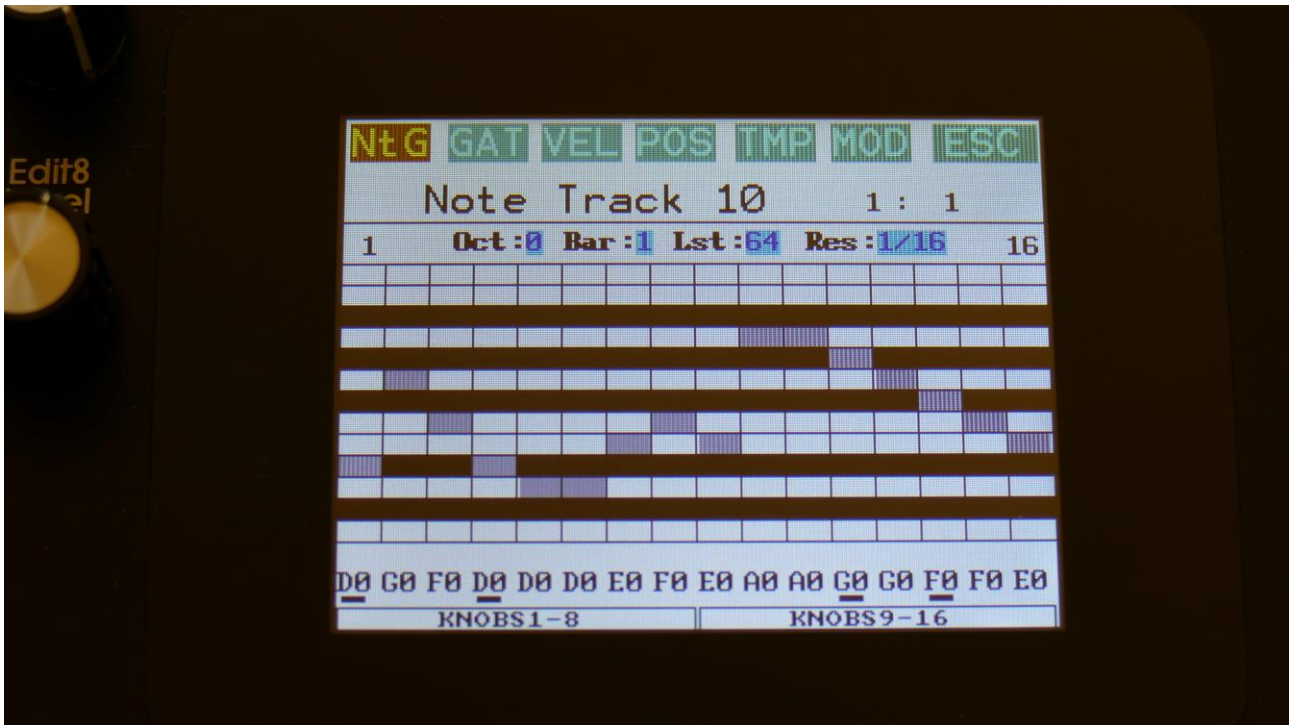

This will be the first page, you will enter, if the Notes parameter on the Seq Main page is set to Grid. At any time, touch NtG/NtV on the top navigation bar, to enter the note values page.

At most of this screen, you will see the note grid. Right above this, to the left and to the right, the first and last step numbers, of the steps that is currently shown in the note grid, are indicated.

Between these numbers, a few settable parameters is shown.

In the top left side, a small VU-meter is shown, that will indicate every time a note is played back.

Here, when neither KNOBS1-8 or KNOBS9-16 is black:

Edit Knob 1: Selects the octave to be viewed. The octave number is shown just above the note grid (marked **Oct**), and the lowest and highest note number is shown below and above the mini keyboard at the left.

Edit Knob 2: Selects the bar to be viewed. 4 bars can be viewed, each showing 16 steps, for a total of 64 steps. The bar number is shown just above the note grid (marked **Bar**), and the first and the last step number viewed, is shown just above the note grid, to the right and the left.

Edit Knob 3: Sets the last step that will be played back on this track, before it loops back, and plays the track again. Range: 1 to 64 steps. Value is shown as **Lst**.

The Last step can be set globally for all tracks at the Seq Main page.

Edit Knob 4: Sets the track resolution. Values: 1/64, 1/48, 1/32, 1/24, 1/16, 1/12, 1/8, 1/6, 1/4, 1/2. Value is shown as **Res**.

The note values for each step is shown right below the note grid. If a black underscore is shown below the number, it means that it is a # note. Note values for each step can be changed, simply by touching the note grid.

Values can also be changed, using edit knob 1 to 8. In the bottom of the page, touch the field named "Knobs 1-8", to edit the first 8 steps, using the edit knobs, or touch the field named "Knobs 9-16", to edit the last 8 steps, using edit knob 1 to 8.

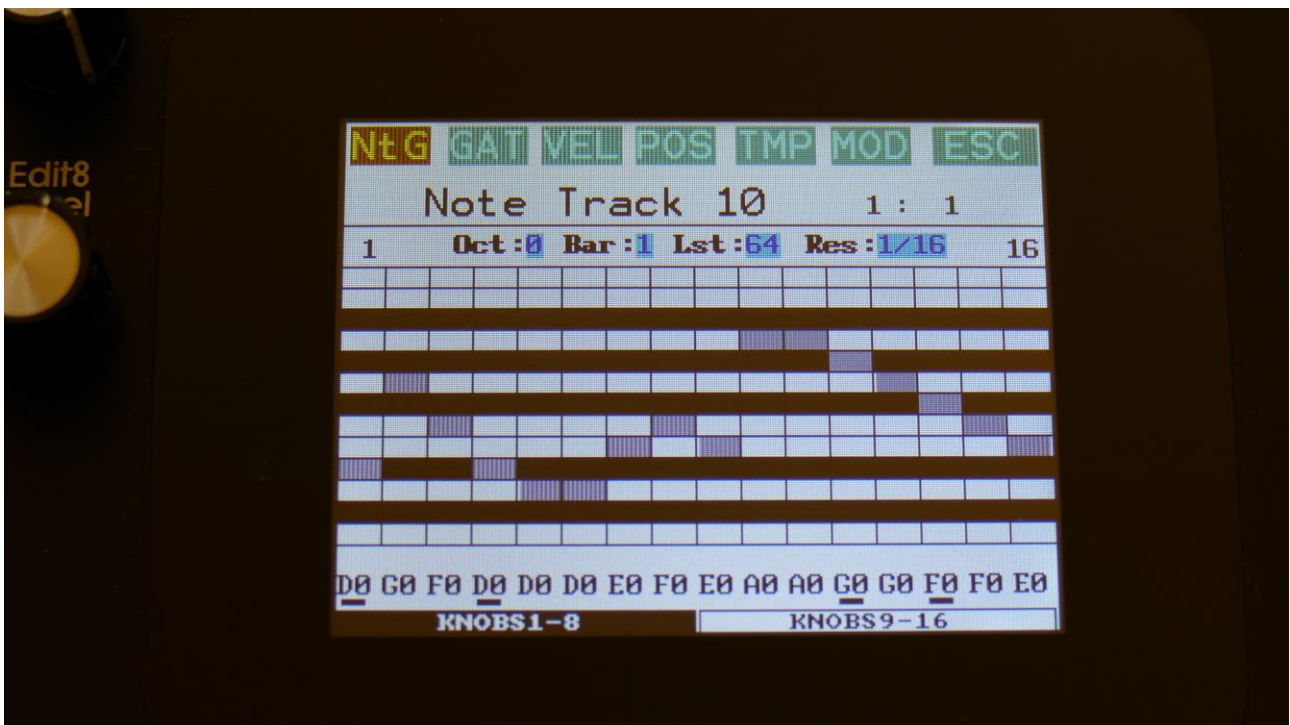

The note grid view are a bit limited, since you can only view one octave at a time. It is also possible to view the whole octave range at one time, by switching to the value bar view mode. Simply touch the NtG square in the upper left corner of the screen, or go to the sequencer main page, and change the Notes parameter to Value. The note values page will now look like this:

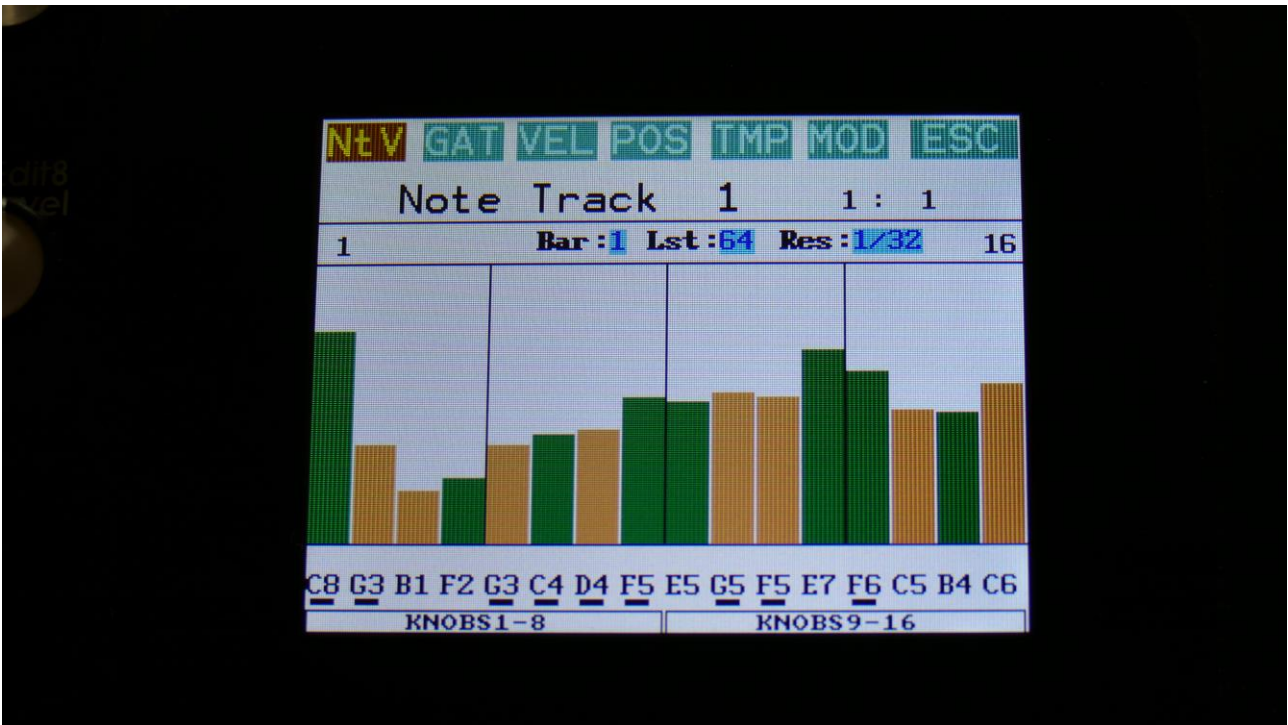

The knob functions are the same on this page, as on the note grid page. Note values can still be entered by touching the value bars, or by the edit knobs.

Steps that are on has a green value bar, steps that are off, has a yellow/red value bar.

Gate Time Subtrack

Touch GAT in the top navigation bar, to enter the gate time steps page. OR: Push and release the Func/Mute button, so that it lights up, and push step button 3/Note Trk 2 times.

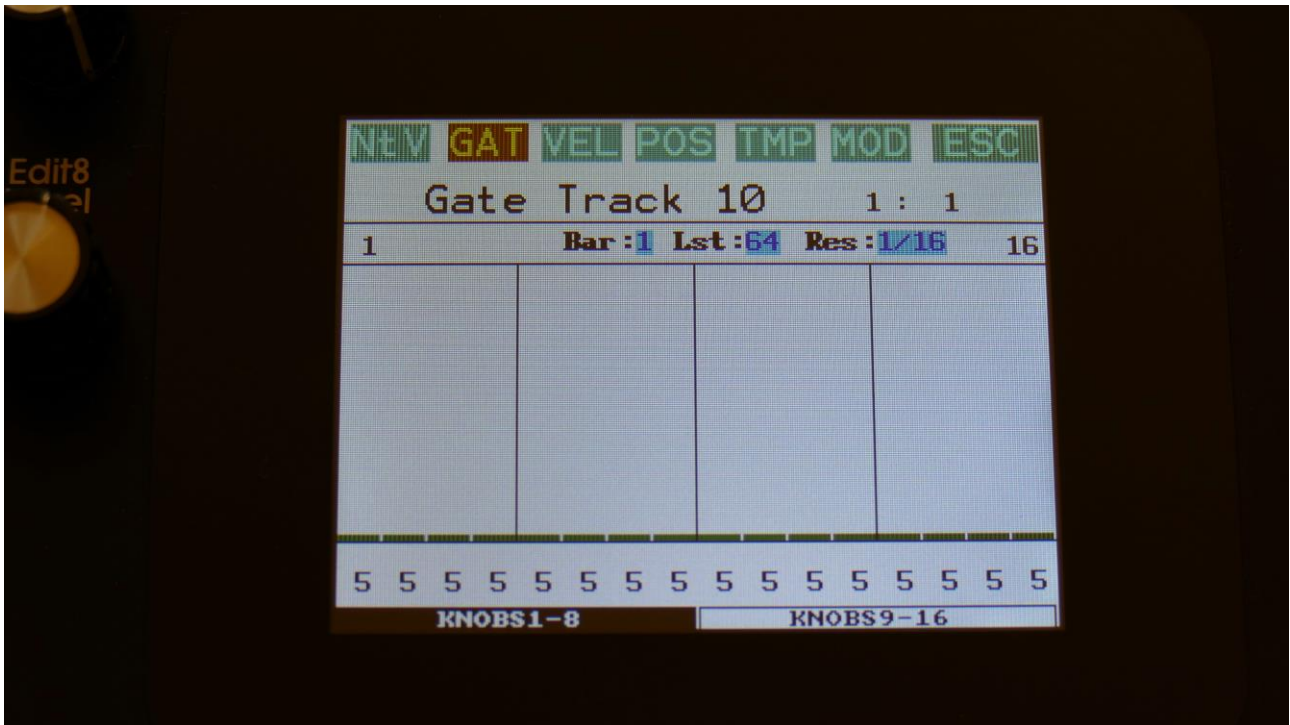

The gate time values for each step is shown as bars in the value grid, and as number right below the value grid. If a black underscore is shown below the number, it means that it is above 100.

Gate time values for each step can be changed, simply by touching the value grid.

Values can also be changed, using edit knob 1 to 8. In the bottom of the page, touch the field named "Knobs 1-8", to edit the first 8 steps, using the edit knobs, or touch the field named "Knobs 9-16", to edit the last 8 steps, using edit knob 1 to 8.

When neither KNOBS1-8 or KNOBS9-16 are black:

Edit Knob 1: Has no function.

Edit Knob 2: Selects the bar to be viewed. 4 bars can be viewed, showing each 16 steps, for a total of 64 steps. The bar number is shown just above the note grid (marked **Bar**), and the first and the last step number viewed, is shown just above the note grid, to the right and the left.

Edit Knob 3: Sets the last step that will be played back on this track, before it loops back, and plays the track again. Range: 1 to 64 steps. Value is shown as **Lst**.

The Last step can be set globally for all tracks at the Seq Main page.

Edit Knob 4: Sets the track resolution. Values: $1/64$, $1/48$, $1/32$, $1/24$, $1/16$, $1/12$, $1/8$, $1/6$, $1/4$, $1/2$. Value is shown as **Res**.

Touching "ESC" will exit you to the Sequencer access page.

Velocity Subtrack

Touch VEL in the top navigation bar, to enter the velocity steps page. OR: Push and release the Func/Mute button, so that it lights up, and push step button 3/Note Trk 3 times.

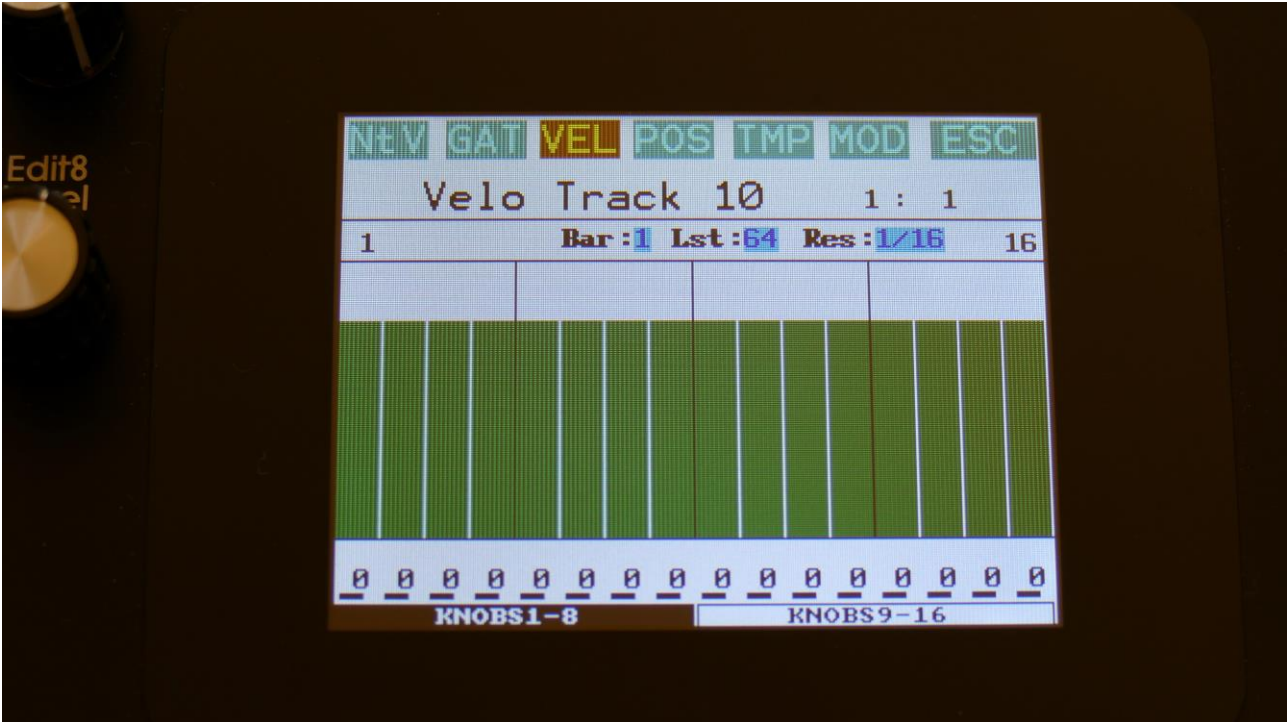

The velocity values for each step is shown as bars in the value grid, and as number right below the value grid. If a black underscore is shown below the number, it means that it is above 100. Velocity values for each step can be changed, simply by touching the value grid.

Values can also be changed, using edit knob 1 to 8. In the bottom of the page, touch the field named "Knobs 1-8", to edit the first 8 steps, using the edit knobs, or touch the field named "Knobs 9-16", to edit the last 8 steps, using edit knob 1 to 8.

When neither KNOBS1-8 or KNOBS9-16 are black:

Edit Knob 1: Has no function.

Edit Knob 2: Selects the bar to be viewed. 4 bars can be viewed, showing each 16 steps, for a total of 64 steps. The bar number is shown just above the values field (marked **Bar**), and the first and the last step number viewed, is shown just above the values field, to the right and the left.

Edit Knob 3: Sets the last step that will be played back on this track, before it loops back, and plays the track again. Range: 1 to 64 steps. Value is shown as **Lst**.

The Last step can be set globally for all tracks at the Seq Main page.

Edit Knob 4: Sets the track resolution. Values: $1/64$, $1/48$, $1/32$, $1/24$, $1/16$, $1/12$, $1/8$, $1/6$, $1/4$, $1/2$. Value is shown as **Res**.

Touching "ESC" will exit you to the Sequencer Modules page.

Position Subtrack

Touch POS in the top navigation bar, to enter the position steps page:

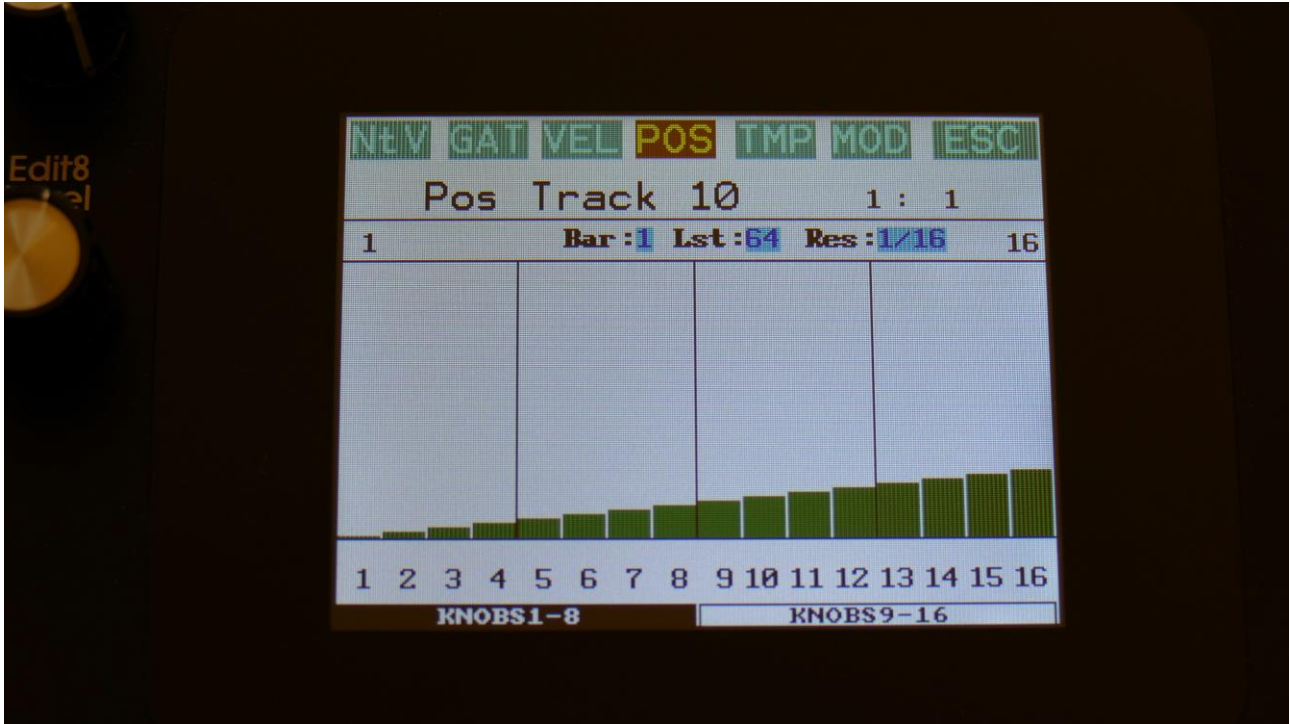

Unlike many other step sequencers, the position for each step on the LD3 note tracks, can be set. For traditional step sequencing, you would leave it at its default setting, when step 1 is played back at position 1, step 2 is played back at position 2 and so on.

But the note sequencer in LD3 can go further than that. Step 2 can be set to play back at position 31, if desired, just to deform a track, or experiment with it, or more steps can be set to play back at the same position, for polyphonic sequencing.

Templates (explained in the next section) are available, to force the position to make the track play forwards, backwards, random, alternating and in many other patterns, if you do not like to set this up yourself.

The position for each step is shown as bars in the value grid, and as number right below the value grid. Positions for each step can be changed, simply by touching the value grid.

Values can also be changed, using edit knob 1 to 8. In the bottom of the page, touch the field named "Knobs 1-8", to edit the first 8 steps, using the edit knobs, or touch the field named "Knobs 9-16", to edit the last 8 steps, using edit knob 1 to 8.

When neither KNOBS1-8 or KNOBS9-16 are black:

Edit Knob 1: Has no function.

Edit Knob 2: Selects the bar to be viewed. 4 bars can be viewed, showing each 16 steps, for a total of 64 steps. The bar number is shown just above the values field (marked **Bar**), and the first and the last step number viewed, is shown just above the values field, to the right and the left.

Edit Knob 3: Sets the last step that will be played back on this track, before it loops back, and plays the track again. Range: 1 to 64 steps. Value is shown as **Lst**.

The Last step can be set globally for all tracks at the Seq Main page.

Edit Knob 4: Sets the track resolution. Values: $1/64$, $1/48$, $1/32$, $1/24$, $1/16$, $1/12$, $1/8$, $1/6$, $1/4$, $1/2$. Value is shown as **Res**.

Touching "ESC" will exit you to the Sequencer Modules page.

Sub Position Subtrack

When on the Position subtrack page, touch POS in the top navigation bar an extra time, to enter the sub position subtrack:

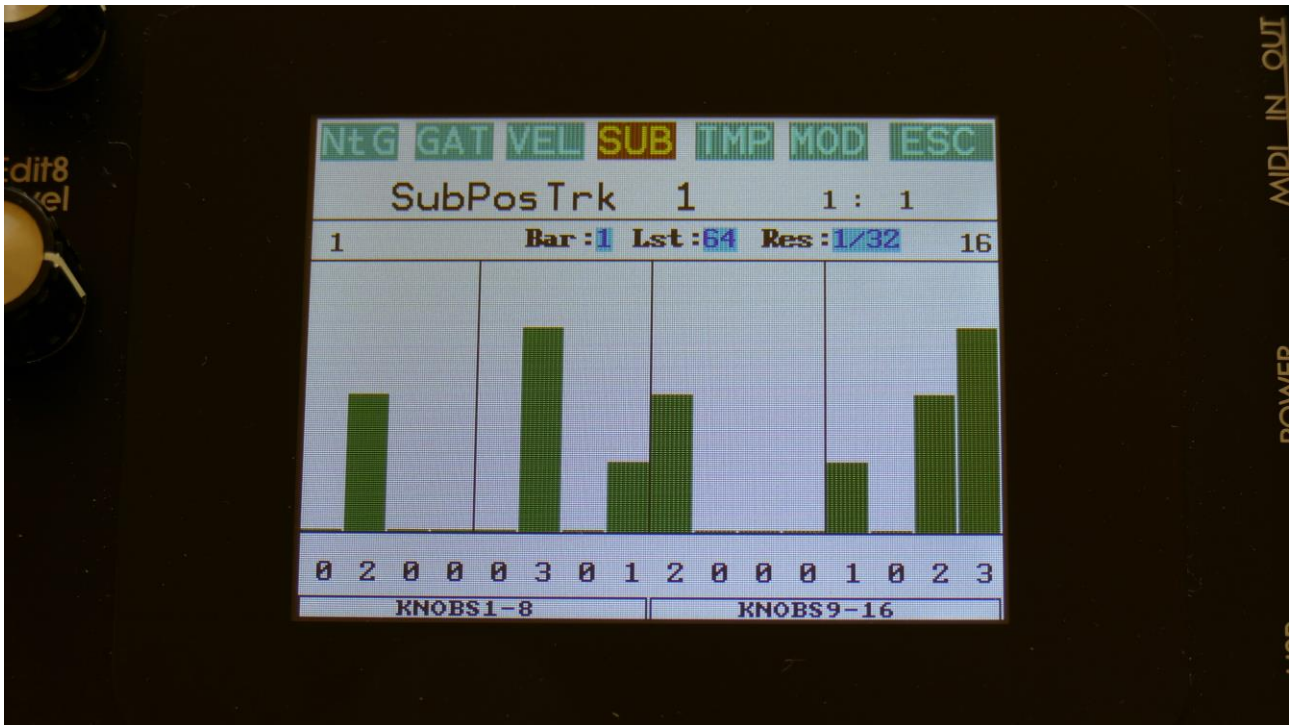

Here a value between 0 and 3 can be added to the step position for “micro-timing”.

The sub position for each step is shown as bars in the value grid, and as number right below the value grid. Sub positions for each step can be changed, simply by touching the value grid. Values can also be changed, using edit knob 1 to 8. In the bottom of the page, touch the field named “Knobs 1-8”, to edit the first 8 steps, using the edit knobs, or touch the field named “Knobs 9-16”, to edit the last 8 steps, using edit knob 1 to 8.

When neither KNOBS1-8 or KNOBS9-16 are black:

Edit Knob 1: Has no function.

Edit Knob 2: Selects the bar to be viewed. 4 bars can be viewed, showing each 16 steps, for a total of 64 steps. The bar number is shown just above the values field (marked **Bar**), and the first and the last step number viewed, is shown just above the values field, to the right and the left.

Edit Knob 3: Sets the last step that will be played back on this track, before it loops back, and plays the track again. Range: 1 to 64 steps. Value is shown as **Lst**.

The Last step can be set globally for all tracks at the Seq Main page.

Edit Knob 4: Sets the track resolution. Values: 1/64, 1/48, 1/32, 1/24, 1/16, 1/12, 1/8, 1/6, ¼, ½. Value is shown as **Res**.

Touching “ESC” will exit you to the Sequencer Modules page.

Templates and Note Scales

Templates are available to make it easier to create ramps on a track, and to randomize things. For the position track templates are available for forwards, backwards, alternating, randomized and polyphonic playback setup.

On this page note scales are also available, for users that thinks that harmonic tones works, and for swapping around keys for experimentation.

When on either the Note, Gate, Velo or position subtracks, touch TMP on the top navigation bar, to enter the templates/note scales page.

If you enter the templates pages from the note, gate or velocity page, it will look like this:

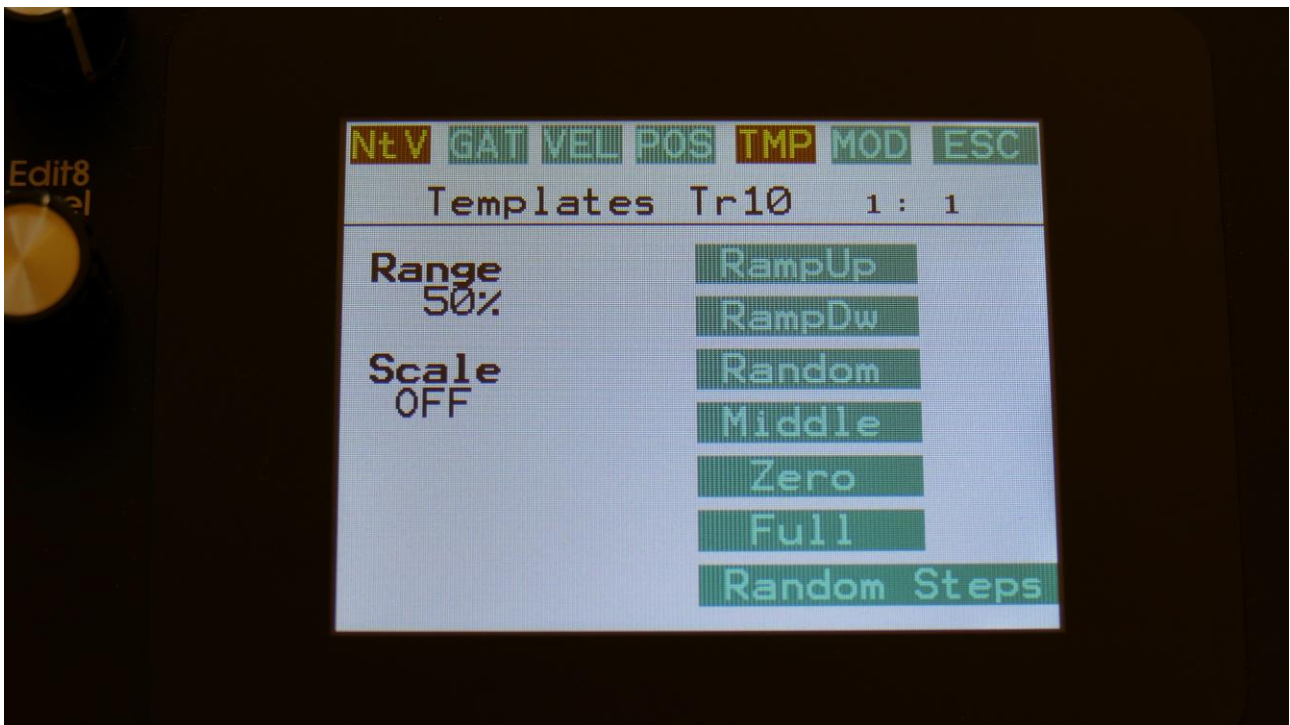

First turn Edit Knob 1, to set the range. This will set, how much the template routine will affect the values, that are already on the selected subtrack. When this is set to 100%, the template function will be absolute. Then touch any of the template boxes in the right side of the screen.

The templates work from step 1 to the last step that is set. Values after the last step are not affected.

Available templates:

-RampUp: Ramp Up. Will lower values on steps, that are placed before last step divided by 2, and raise values on steps, placed after last step divided by 2.

-RampDw: Ramp Down. Will raise values on steps, that are placed before last step divided by 2, and lower values on steps, placed after last step divided by 2.

-Random: Will randomize all steps between step 1 and last step, to a degree set by the range parameter.

-Middle: Will move any values closer to the middle value.

-Zero: Will lower any values. –Transpose a note track down.

-Full: Will raise any values. –Transpose a note track up.

Random Steps:

Will randomize the note steps on's/off's. The more that the Range parameter is turned up, the more notes it will set to on.

Scale: Adds a scale to the note track output in realtime, when adjusting Edit Knob 5. Available scales are:

-Off: No scales are added to the note track.

-Cmaj: Forces all notes outputted from the track, to the Cmajor scale.

-Dmaj: Forces all notes outputted from the track, to the Dmajor scale.

-Emaj: Forces all notes outputted from the track, to the Emajor scale.

-Fmaj: Forces all notes outputted from the track, to the Fmajor scale.

-Gmaj: Forces all notes outputted from the track, to the Gmajor scale.

-Amaj: Forces all notes outputted from the track, to the Amajor scale.

-Bmin: Forces all notes outputted from the track, to the Bmajor scale.

-Cmin: Forces all notes outputted from the track, to the Cminor scale.

-Dmin: Forces all notes outputted from the track, to the Dminor scale.

-Emin: Forces all notes outputted from the track, to the Eminor scale.

-Fmin: Forces all notes outputted from the track, to the Fminor scale.

-Gmin: Forces all notes outputted from the track, to the Gminor scale.

-Amin: Forces all notes outputted from the track, to the Aminor scale.

-Bmin: Forces all notes outputted from the track, to the Bminor scale.

-Swap: Will swap notes below F inside an octave, with notes above F, and vice versa.

-BIWh: Will swap white keys with black and vice versa.

Templates for the Position Subtrack

When entering the templates page from the Position subtrack, it will look like this:

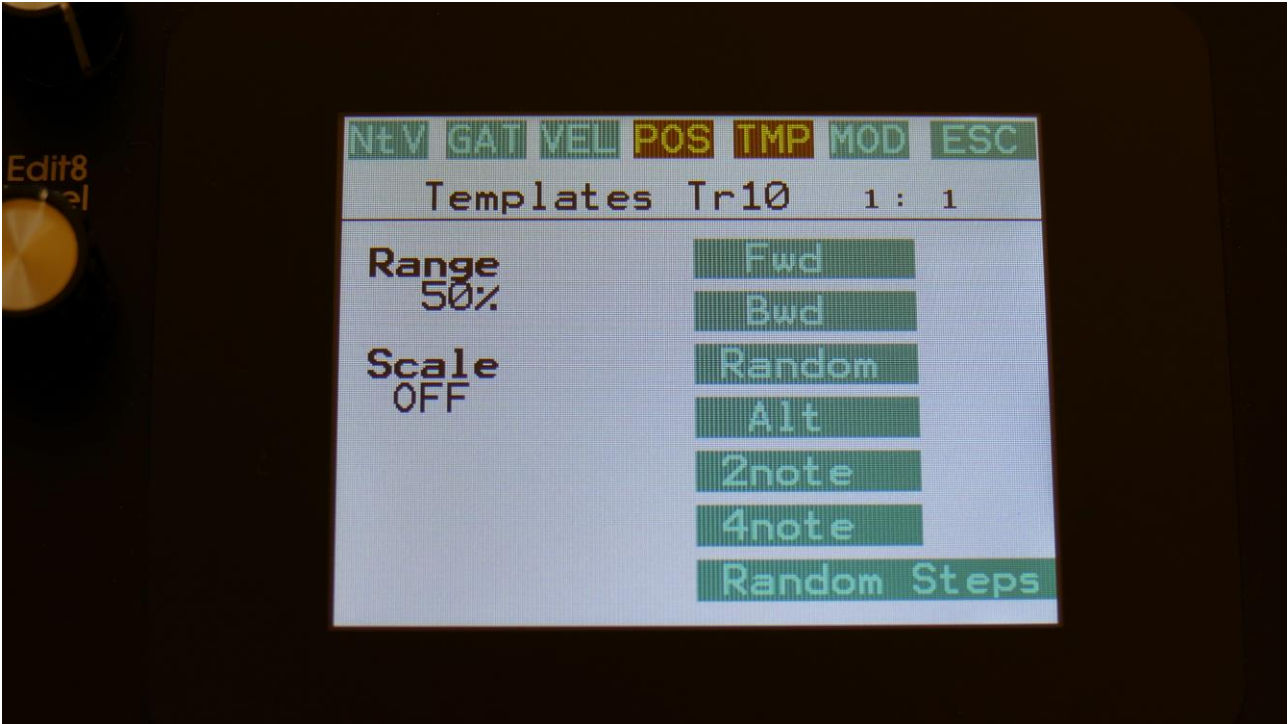

Turn Edit Knob 1, to set the range. This will set, how much the template routine will affect the values, that are already on the selected subtrack. When this is set to 100%, the template function will be absolute.

The templates work from step 1 to the last step that is set. Values after the last step are not affected.

Available templates:

- Fwd**: Forwards. The more the Range parameter is turned up, when touching this, the more the track will be forced to play back forwards.
- Bwd**: Backwards. The more the Range parameter is turned up, when touching this, the more the track will be forced to play back backwards.
- Random**: Will randomize all steps between step 1 and last step, to a degree set by the range parameter.
- Alt**: Alternate. The more the Range parameter is turned up, when touching this, the more the track will be forced to play back alternating.

-2note: 2 Note Poly. The more the Range parameter is turned up, when touching this, the more the track will be forced to play back 2 note polyphonic.

-4note: 4 Note Poly. The more the Range parameter is turned up, when touching this, the more the track will be forced to play back 4 note polyphonic.

Random Steps:

Will randomize the note steps on's/off's. The more that the Range parameter is turned up, the more notes it will set to on.

Note Track Mod Page

Touch MOD in the top navigation bar, to enter this page. OR: Push and release the Func/Mute button, so that it lights up, and push step button 3/Note Trk 4 times.

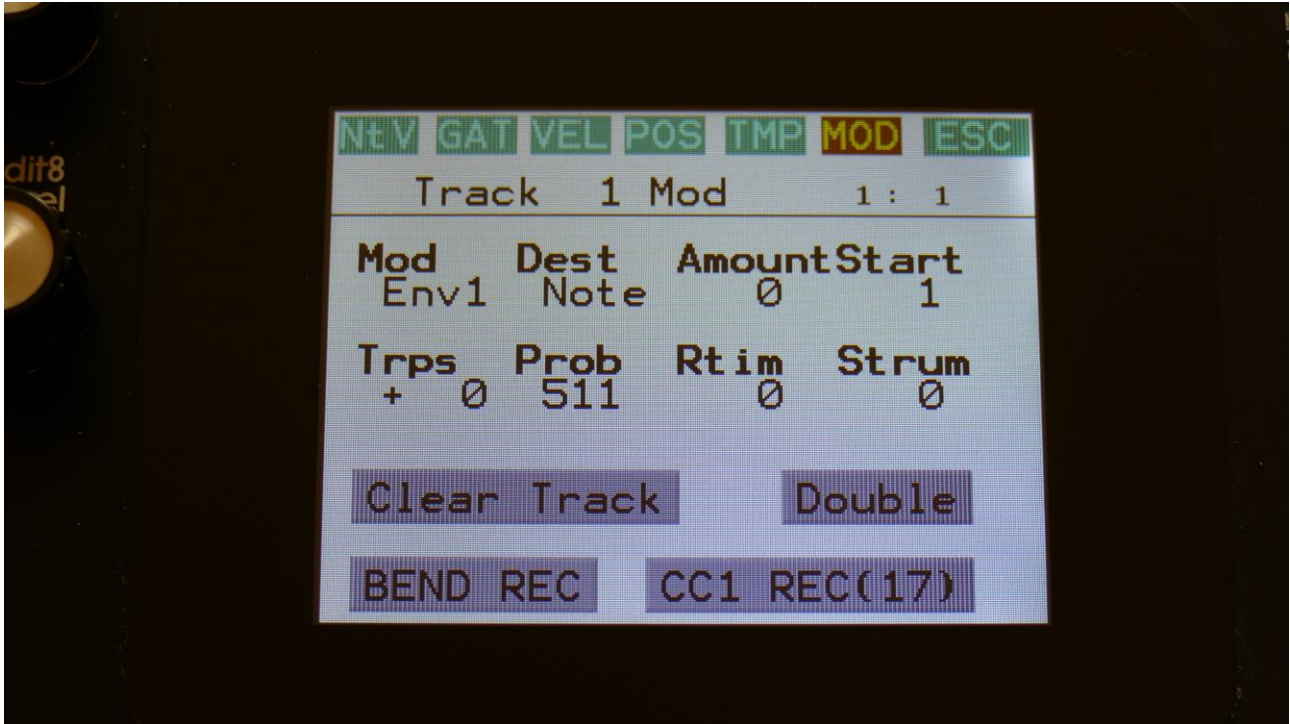

Here you can set up note track modulation, the track Note Randomizer, the start step, make the track strum, and transpose the track. It is also possible to clear or double the track.

The parameters of this page:

Mod: Note Track modulation source. Any LD3 modulation source can be selected to modulate the track. For a complete list of modulation sources, see the list in the start of the synth part section in this manual.

Dest: Track modulation destination. Selects what should be modulated on the track. Choices are:

-**Note:** The note numbers of the track will be modulated.

-**Gate:** The gate times of the track will be modulated.

-**Dly:** The delay times of the track will be modulated.

-**Swing:** Swing modulation will be applied to the track. This is a bit more fine than the delay time modulation.

-**Velo:** The velocity values of the track will be modulated.

-**Pos:** The position subtrack positions will be modulated.

-**Strum:** The Strum parameter will be modulated.

Amount: Adjusts the amount of modulation that will be applied to the track.

Start: Sets the track start step. This will be the step, the track starts at, when hitting the Start/Stop button, or when entering this preset from another preset, while the sequencer is running. When selecting another preset, while the sequencer is running, the preset change will happen, when Note track 1 are at the step before the start step. Step 1 to 64 can be selected.

The Start step can be set globally for all tracks at the Seq Main page.

Trps: Track transpose. Will transpose the note numbers of the whole track up to 64 semitones up or down.

Prob: Track Note Randomizer Probability. When this is turned fully up, all programmed note steps of the track will play back. The more it is turned down, the less notes will play back. The notes the will not play back are selected randomly.

Rtim: Track Note Randomizer Time. When turned up, it will create random delays on the programmed note steps triggering.

Strum: When the track is playing more than one note at the same time, the more the Strum parameter is turned up, the longer the delay between each note will be.

Clear Note Track

From the Mod page, touch the “**Clear Track**” button, to enter this page:

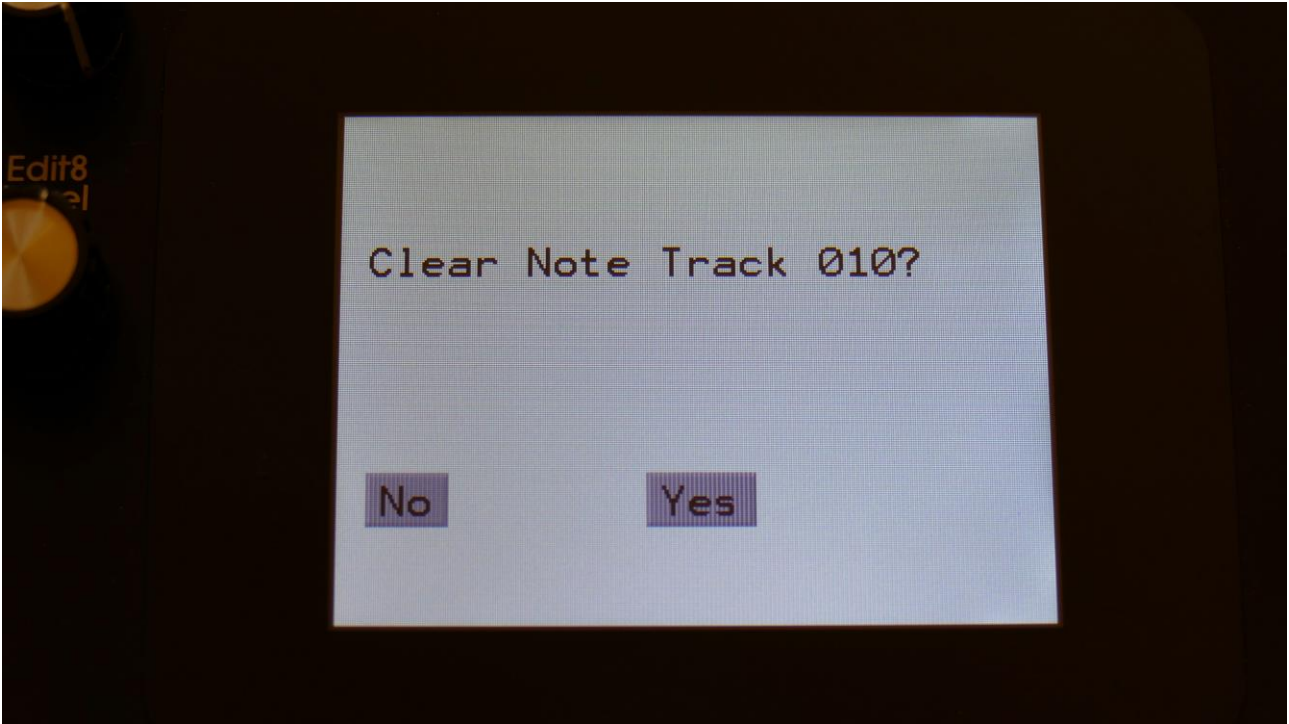

Touching “Yes” from here, will initialize all step values and parameters of the currently selected note track, except for the Last Step parameter.

If you would not wish to do this, touch “No”, to exit to the track Mod page.

Double Note Track

Touch the “Double” touch button, to double the length of the track. All events from the original track, is copied to the new half. Useful if you need some extra variation in a track.

PLEASE NOTE: The track lengths cannot exceed 64 steps for the note tracks.

Realtime recording of notes

You can, at any time, hit the Steps/Part button, and switch note steps on or off, but sometimes you might like to just record something, that you play on a connected MIDI device, like a keyboard or a drum pad, on the touch screen keyboard, or on LD3's trigger buttons. For this, realtime recording is usable.

You can start realtime recording by holding down the Func/Mute button, while pressing the Start/Stop button. If the sequencer is already running, it will immediately enter realtime recording mode, and any note you play will be recorded. If the sequencer is stopped, you will have to push the Start/Stop button, to start it. Before it starts realtime recording, it will count in for 2 bars with audible metronome.

When realtime recording, the Start/Stop button will flash in time with the beat.

To switch off realtime recording, simply hit the same button combination again, so the Start/Stop button stops flashing.

LD3 has two different note realtime recording modes: Mono and poly.

In mono recording mode, it records the notes in a linear time fashion, like a traditional step sequencer: One note per step. The notes you play are placed at the position where the sequencer was playing back, at the moment that you played the note. If you play more than one note on the same position, only the last note you play are recorded.

If you play several parts at the same time, each part will be recorded on separate tracks, so more parts can be recorded to sound at the same time.

In poly recording mode, the position subtrack is modified every time you play a note to be recorded. The first note you play, will be placed at step one, and the position of step one, will be set to the position, that the sequencer was playing back, when you played the note. The second note you play, will be placed at step two, and the position of step two, will be set to the position, that the sequencer was playing back, when you played the note. And so on, until you have played 64 notes. Any step can be at any position, and therefore polyphonic recording and play back is possible.

The realtime recording mode is set on the Sequencer Main page, by adjusting the Rec parameter.

The choices are:

-Mono: Monophonic recording

-Poly: Polyphonic recording

-Audio: Audio track recording (Explained a little bit later in this manual)

-AudCH: Chopped audio track recording (Explained a little bit later in this manual)



On the Sequencer Main page, it is also possible to switch realtime recording on and off, by touching the Rec touchbutton.

Step Recording of Notes

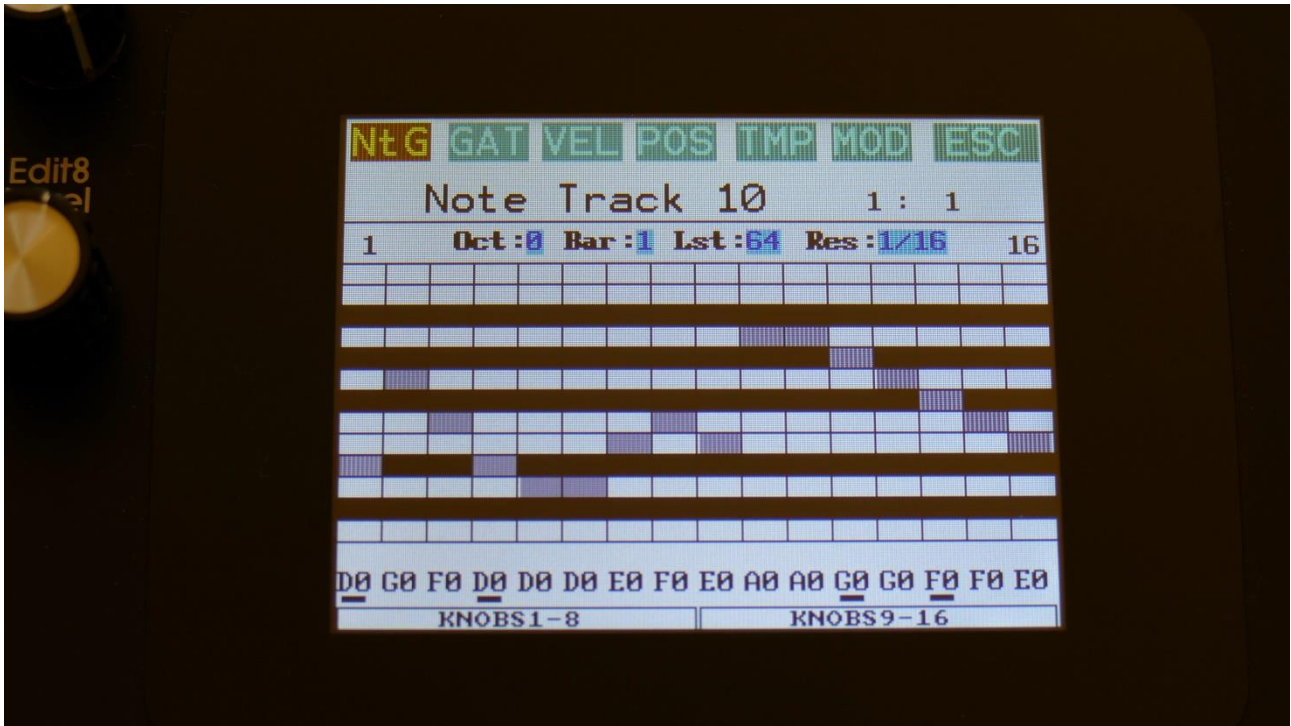

On top of the xox style and realtime recording methods, step recording of notes and controllers are also possible.

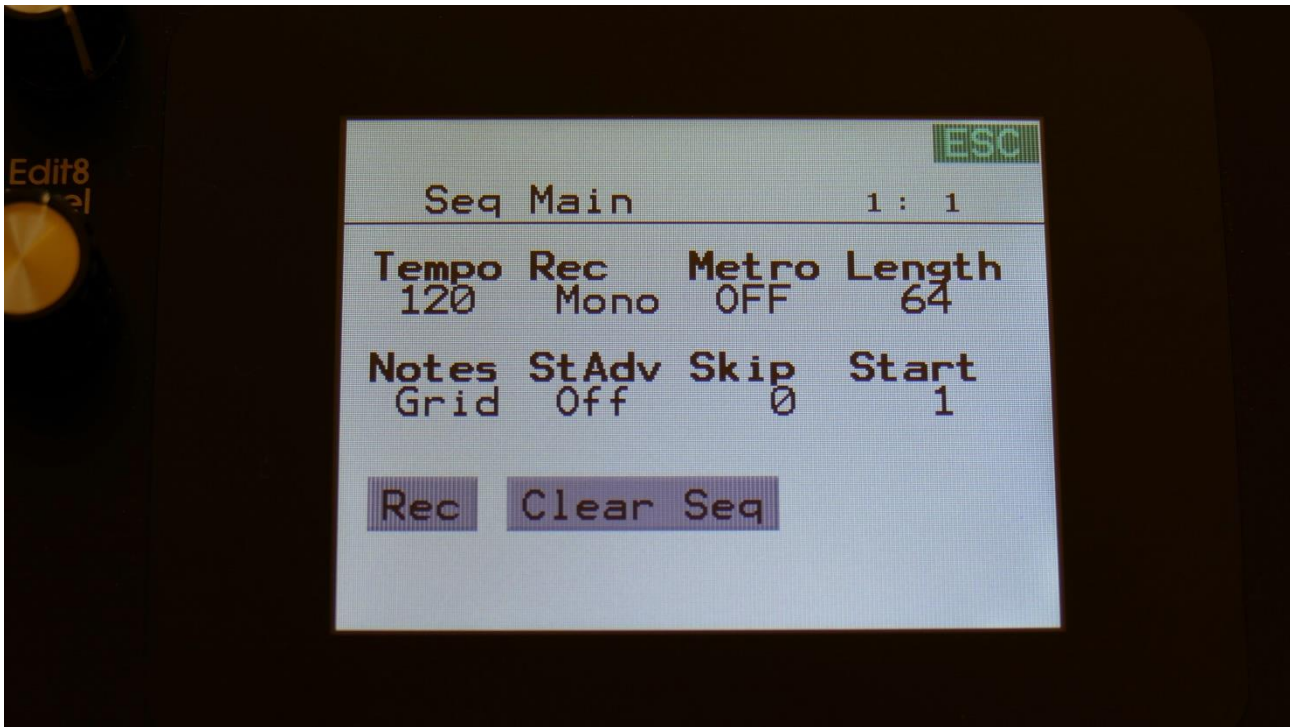

On the sequencer main page, it is by the StAdv (Step Advance) parameter possible to set, if the sequencer, when step recording, should automatically advance to the next step or not.

Rec mode can be set to either mono or poly.

To initiate step recording:

- Set LD3 in sequencer recording mode, by touching the REC field on the sequencer main page or on the preset select page, so that it turns red, or push and hold the Func/Mute button, while pressing the Start/Stop button.
- Start the sequencer playback, if desired. Step recording is possible no matter if the sequencer is running or not.
- Push and release the Steps/Part button, so that it lights up, and puts the 16 step buttons in step mode.
- Push the step button, that has the position for the step, that you would like to record. This will now flash.
- Play a note (or more in poly rec mode), on an attached MIDI device or on the touch screen keyboard. This will now be recorded. If any controller track is set in recording mode (explained in the next section), MIDI CC's and knob movements can also be recorded to specific steps this way.
- If Step Advance is set to on, LD3 will advance to the next step, every time it receives a note off.
- Else, now select another step to record.

If the sequencer is running, while step recording, the time you hold down a note, will be recorded.
If the sequencer is stopped, resolution will determine the note length.

Setting up a track/part to internal or external operation

Each of the 16 LD3 note tracks, can control either the internal part, that they are hard assigned to, or external MIDI gear.

When a part/track is set up to external MIDI control, the internal part can not make any sound.

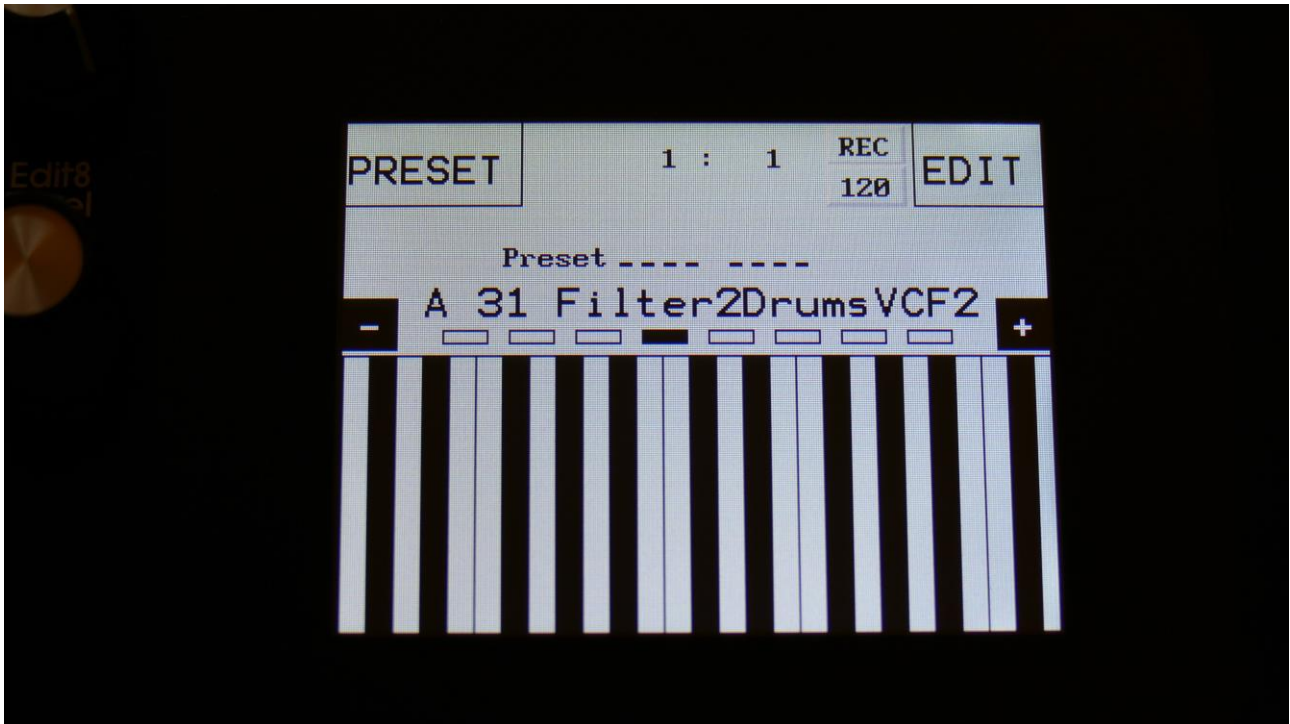

From the Preset Select page, touch the EDIT field, to enter the main synth page.

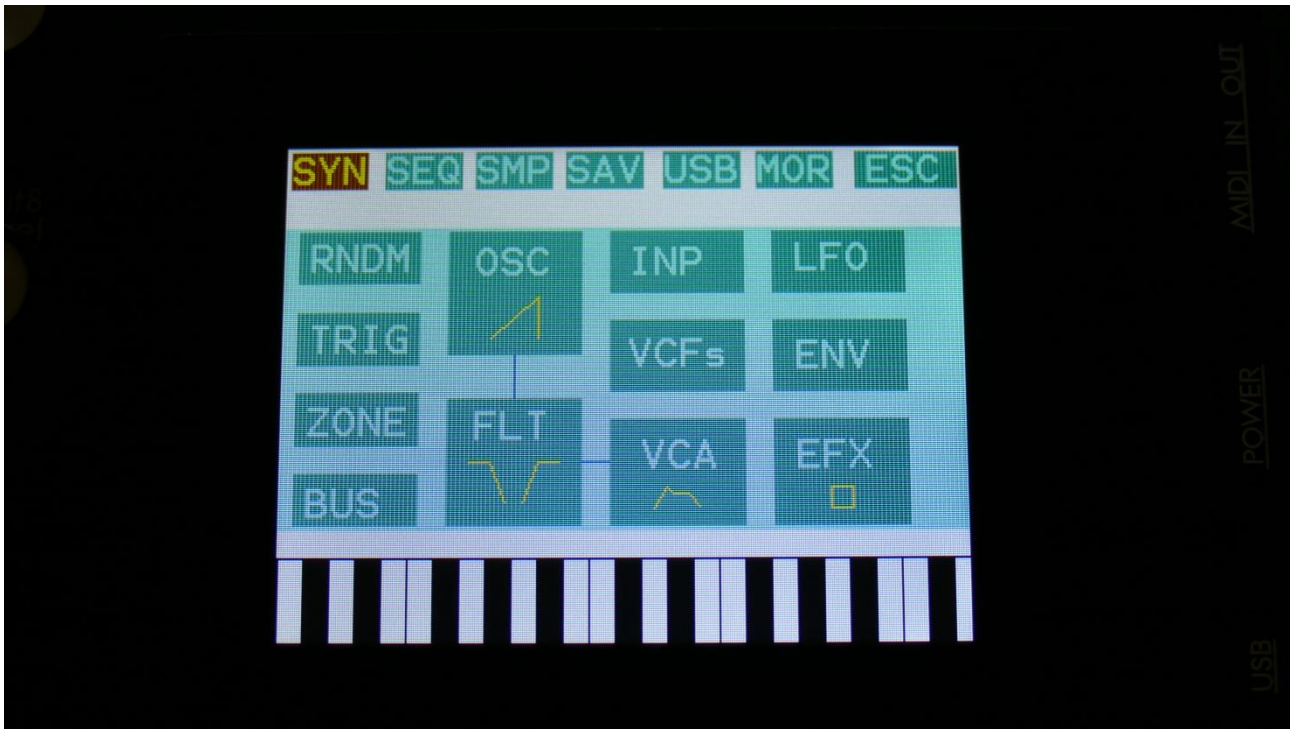

On this page, touch TRIG.

Now you will enter this page:

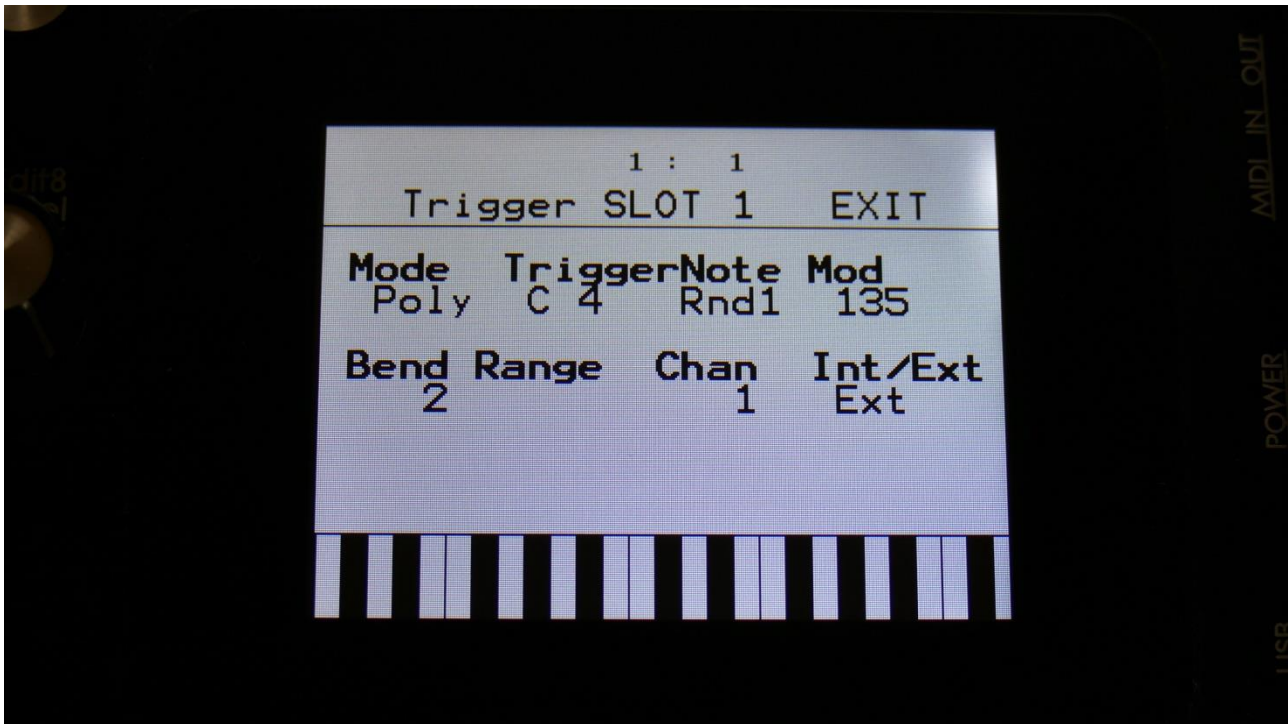

Select the part, that you would like to set up as internal or external, by holding down the Steps/part button, while pushing the step button, that has the desired part number.

Set the Int/Ext parameter to Int (Internal) or Ext (External).

If you set the part to external, set the Chan parameter to a MIDI channel that matches the MIDI gear, that you would like to control.

Set other track up, if desired.

Audio Track Recording

Each of the 16 LD3 note tracks, can be set up to function as an audio track. 8 audio tracks can play back at a time, and each can be either in mono or in stereo. One audio track can be recorded at a time.

Audio tracks can either be recorded as one whole piece (un-chopped), or they can be recorded as a number of smaller pieces, that can be re-arranged afterwards (chopped).

An audio track will be the same length, as the note track you are recording to, is set to. When recording chopped, the chops size will follow the resolution set on the note track. So if you plan to rearrange the track afterwards, it will probably be best to set it to as low a resolution as possible, while still getting the desired length.

When you just wants to record one whole piece, it is best to set the resolution as high as possible, so that you will get a longer recording – up to 32 bars, when resolution is set to $\frac{1}{2}$.

When recording a chopped audio track, the controller track that has the same number, as the note track you are recording, will be reserved by the system as a modulator for the oscillator chop select parameter. To rearrange the chopped pieces of the audio track, you will have to enter this controller track, and change the controller step values.

Audio track setup.

From the Preset select page, touch the EDIT field, to enter the synth main page.

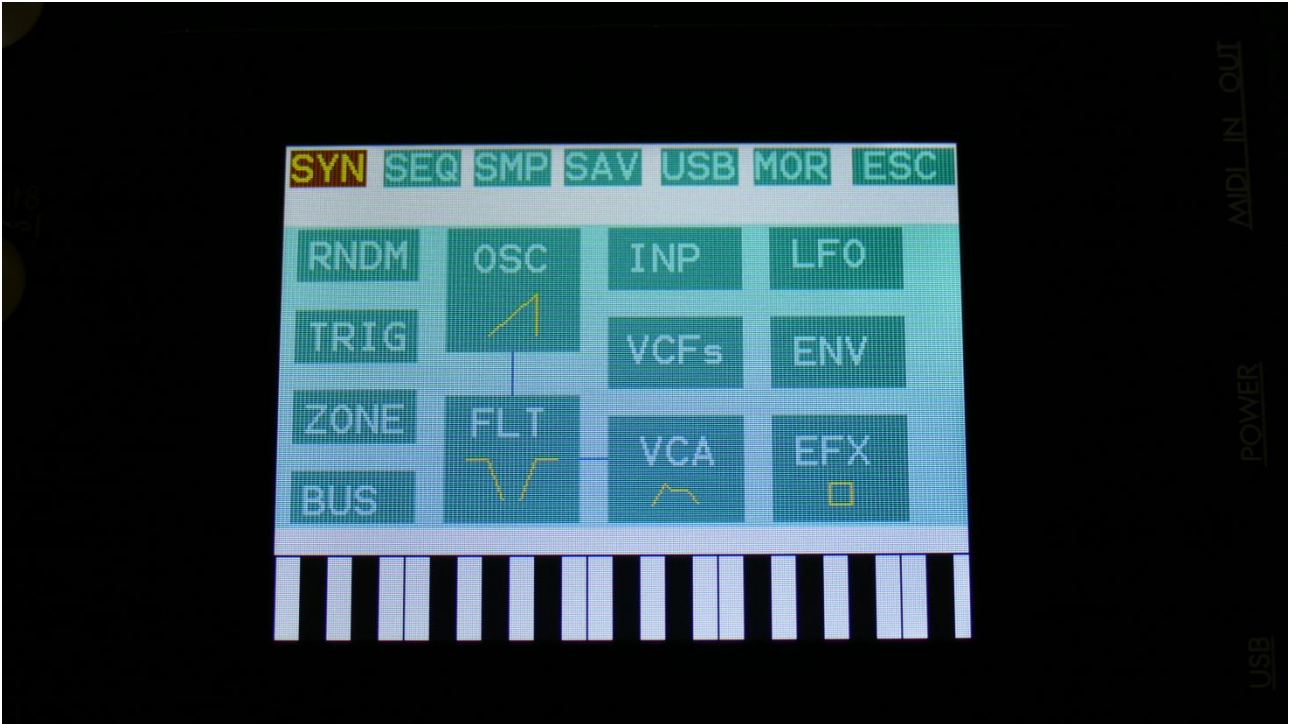

Touch SMP on the top navigation bar.

You should now enter this page:



Touch the REC touch button.

And you should get here:

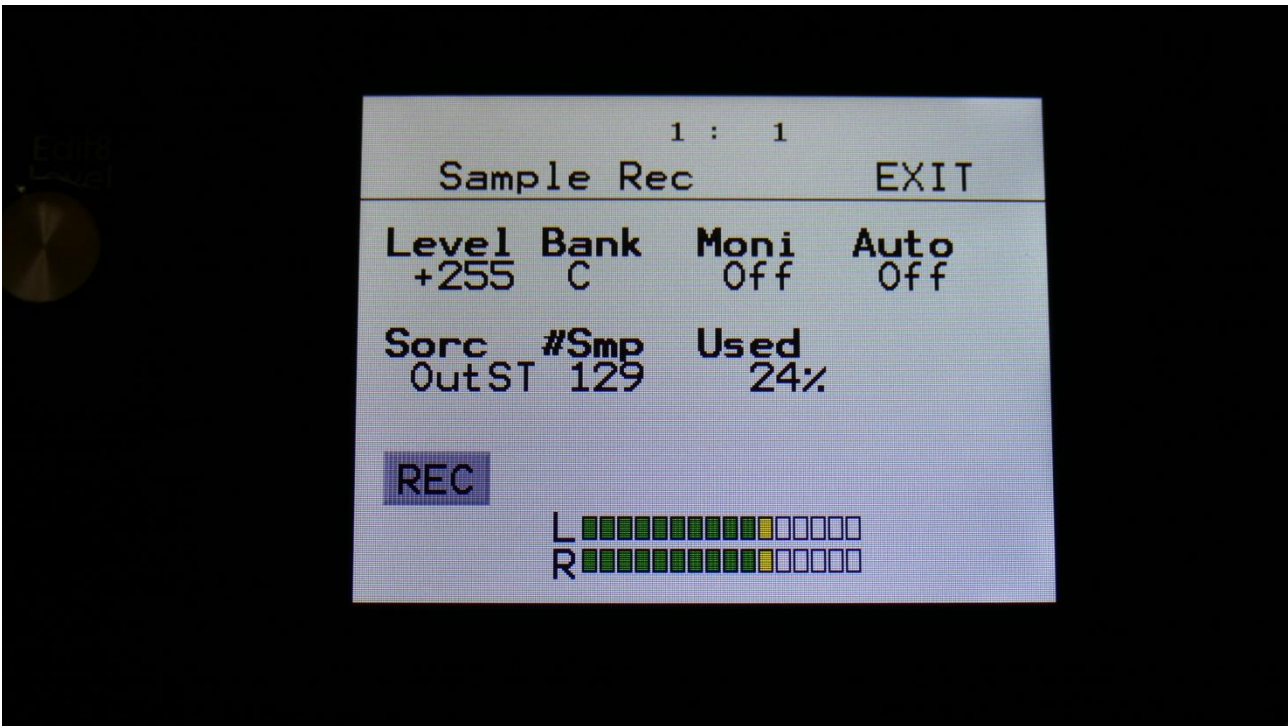

OR, from any page:

-Push and release the Func/Mute button, so it is lighting up.

-Push step button 12, marked "Sample/Qrec".

This will also get you to this page, just much faster.

If you can already hear the source, that you would like to record, leave the Moni parameter Off. If you have the record source connected directly to any of LD3's audio inputs, and can't hear it now, switch the Moni parameter to On. If you only want to listen to the record source, while it is recording, and get the source signal switched off, at the moment recording stops, and the tracks starts to play back, set the Moni parameter to Rec.

Select the record source, by setting the Src parameter.

Choices are:

InpL : Left audio input mono

InpR : Right audio input mono

InpST : Left and right audio inputs stereo

OutpL : Left audio output mono

OutpR : Right audio output mono

OutST : Left and right audio outputs stereo

Inp 3 : Audio input 3 mono

Inp 4 : Audio input 4 mono
In3+4 : Audio inputs 3 and 4 stereo
Outp3 : Audio output 3 mono
Outp4 : Audio output 4 mono
Ou3+4 : Audio outputs 3 and 4 stereo
Inp 5 : Audio input 5 mono
Inp 6 : Audio input 6 mono
In5+6 : Audio inputs 5 and 6 stereo
Outp5 : Audio output 5 mono
Outp6 : Audio output 6 mono
Ou5+6 : Audio outputs 5 and 6 stereo

Now select the sample bank, that you would like to record to, setting the Bank parameter to bank A, B, C or D.

When choosing a bank, the **#Smp** parameter will show how many sampling that the selected bank already holds, and the **Used** parameter will show how many percent of the sample bank, that are already in use.

For optimal results, set the level parameter to +0, and adjust the level of the record source, so that the 2 VU-meters in the bottom of the screen does not get red.

You should only adjust the level parameter, to other values than +0, if it is not possible to adjust the level directly on the source.

Now go to the sequencer note track page, either by:



Exit the Sample Rec page, by touching EXIT in the upper right corner, to go back to the Sample Edit page.

Touch SEQ on the top navigation bar.

You should now have entered this page:

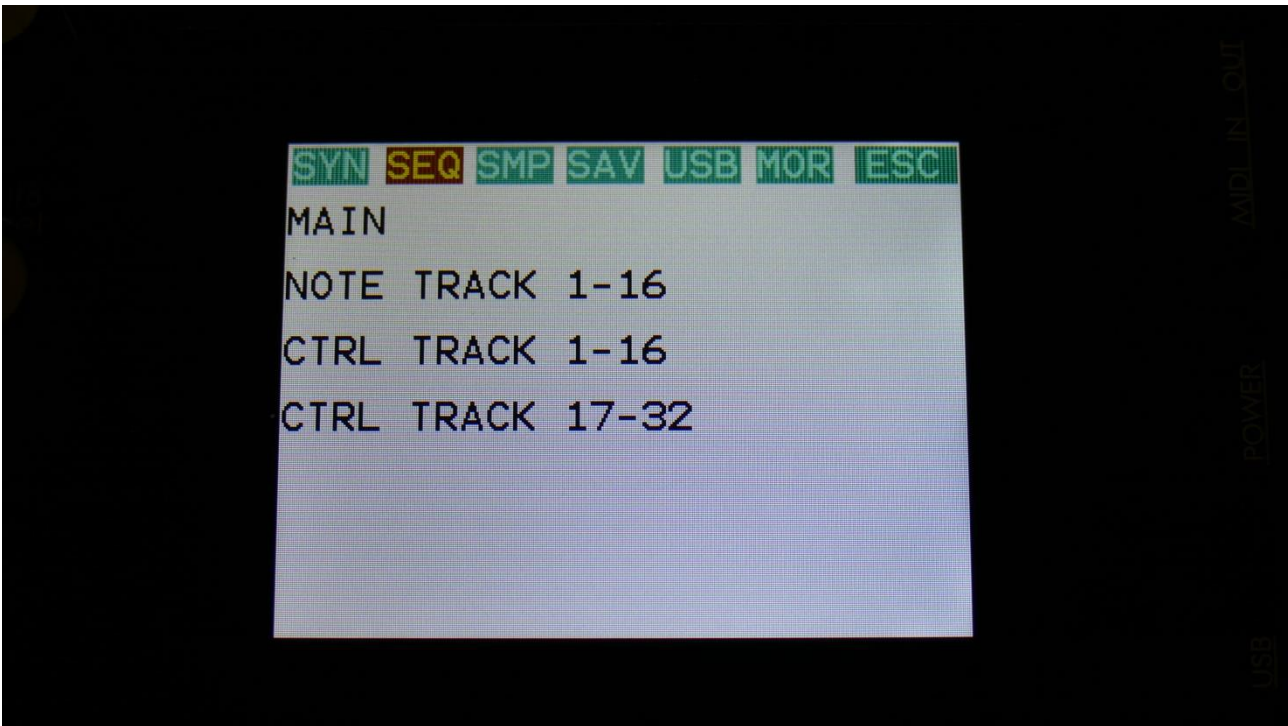

Touch NOTE TRACK 1-16, to enter the note track page.

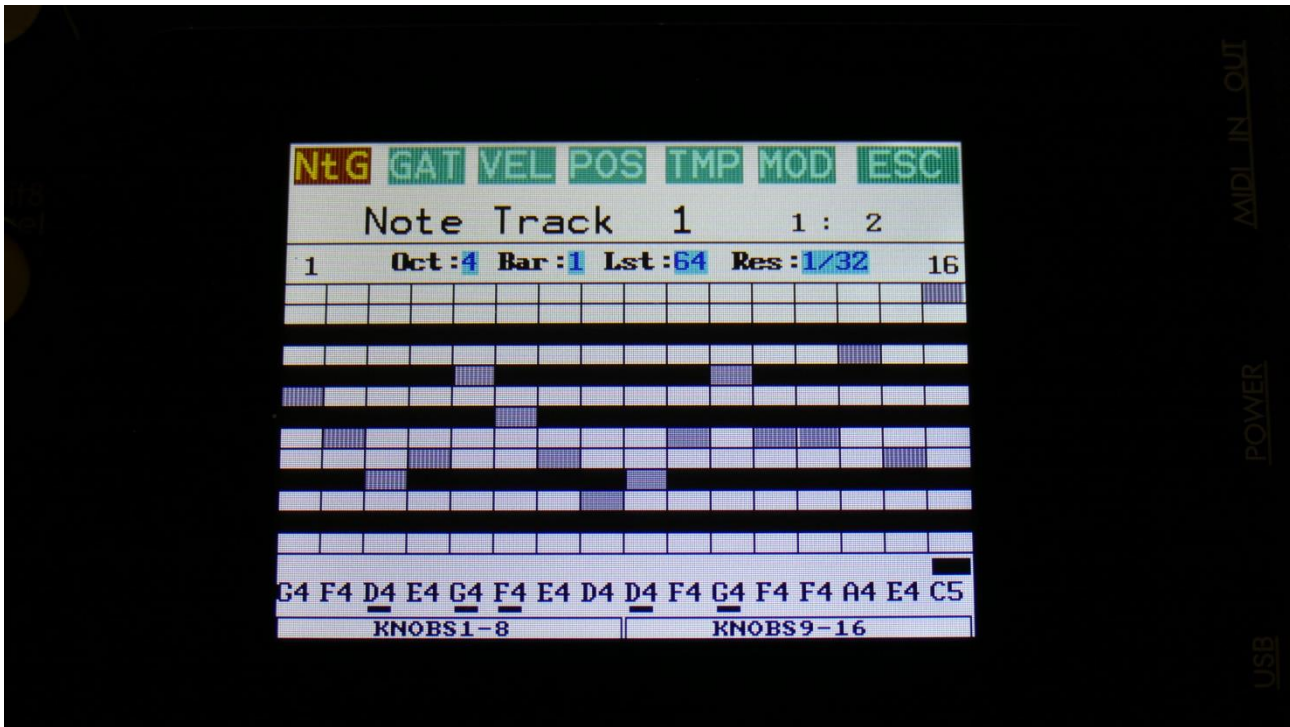

And the faster way to go from the Sample Rec page to the Note Track page:

- Push and release the Func/Mute button, so it is lighting up.
- Push step button 3, marked "Note Trk".

- Now, select the note track, that you would like to record.
- Set the desired length and resolution.

Go to the sequencer main page, by touching ESC on the top navigation bar, to go back to the Seq overview page.

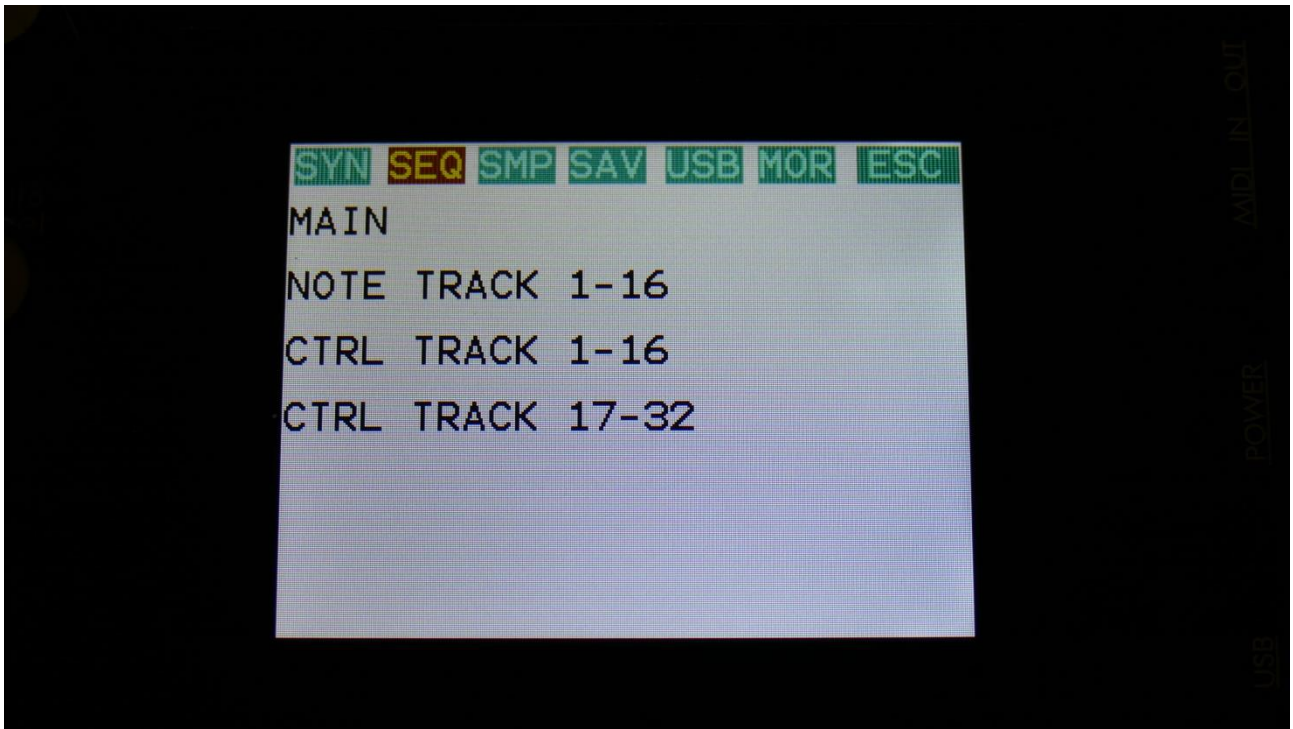

Touch MAIN.

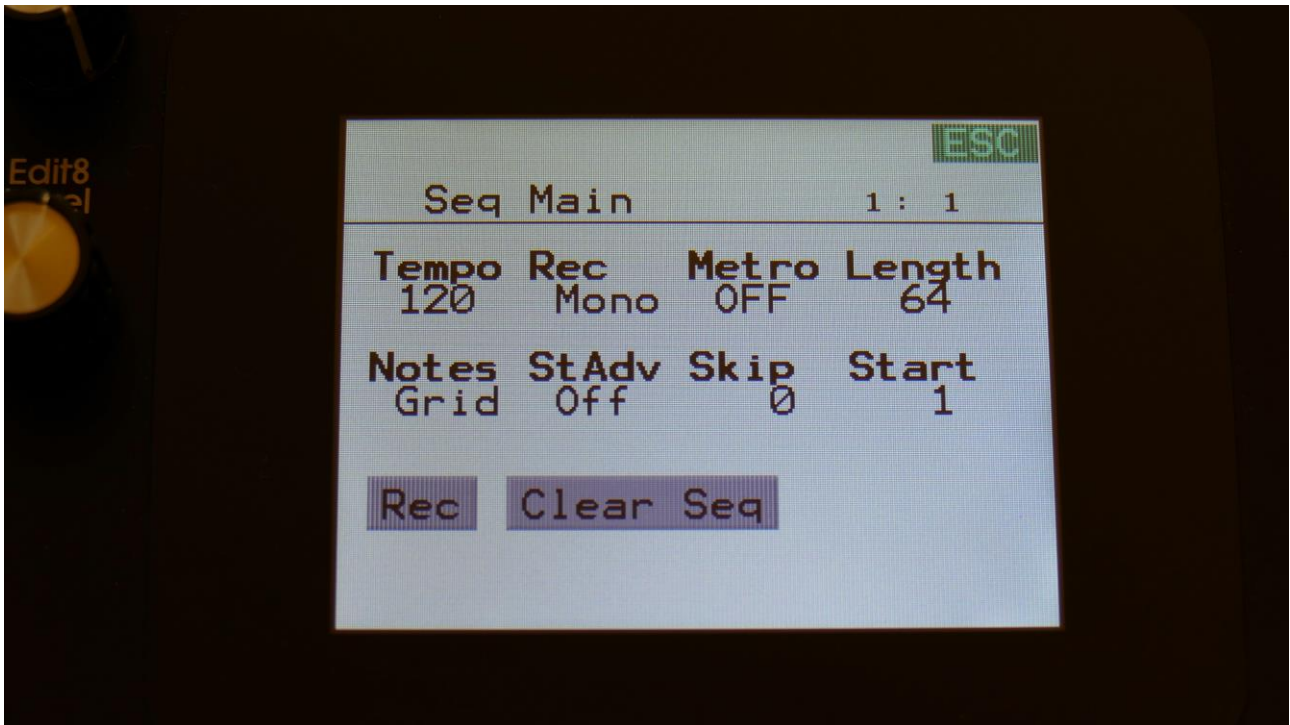

And the faster way to go from the Note track page to the Sequencer Main page:

- Push and release the Func/Mute button, so it is lighting up.
- Push step button 2, marked "Seq Main".

Set the desired tempo.

Switch the metronome on, if desired.

Set the Rec parameter to either Audio, if you would like to record one long piece, or to AudCH, if you would like your recording chopped up.

To start recording, either touch the Rec touch button, or hold down the Func/Mute button, while pushing the Start/Stop button.

If the sequencer is already running, it will start recording the audio track, the next time the track starts over from step 1.

If the sequencer is not already running, push the Start/Stop button, to start it. LD3 will now count in for 2 bars, with the metronome audible, and then start recording.

As soon as it reaches the track last step, recording will stop, and the track will start to play back.

The Controller Tracks

LD3 has 32 controller tracks. Each of these only have one subtrack: The controller track values. Each track can be on up to 128 steps long, and a Smooth function can be turned on, that will automatically create values between the steps, from one step value to another, for smooth transitions between them.

Each controller track both creates an internal modulation source and a MIDI CC or Pitch Bend source. The MIDI CC's and Pitch Bend sources can be sent both to external MIDI gear, and internally.

Via the controller tracks, it is possible to realtime record MIDI CC's, pitch bends and knob movements.

Templates are available, for quick modification of the controller track values.

Controller track Step Values

From the sequencer access page, touch Controller Track 1 to 16, to access these controller tracks, or touch Controller Track 17 to 32, to access these tracks. OR: Push and release the Func/Mute button, so that it lights up, and push step button 4/Ctrl Trk 1 time to enter tracks 1-16, and 3 times to enter tracks 17-32.

To access a specific track, push and hold the Steps/Part button, while pressing one of the step buttons.

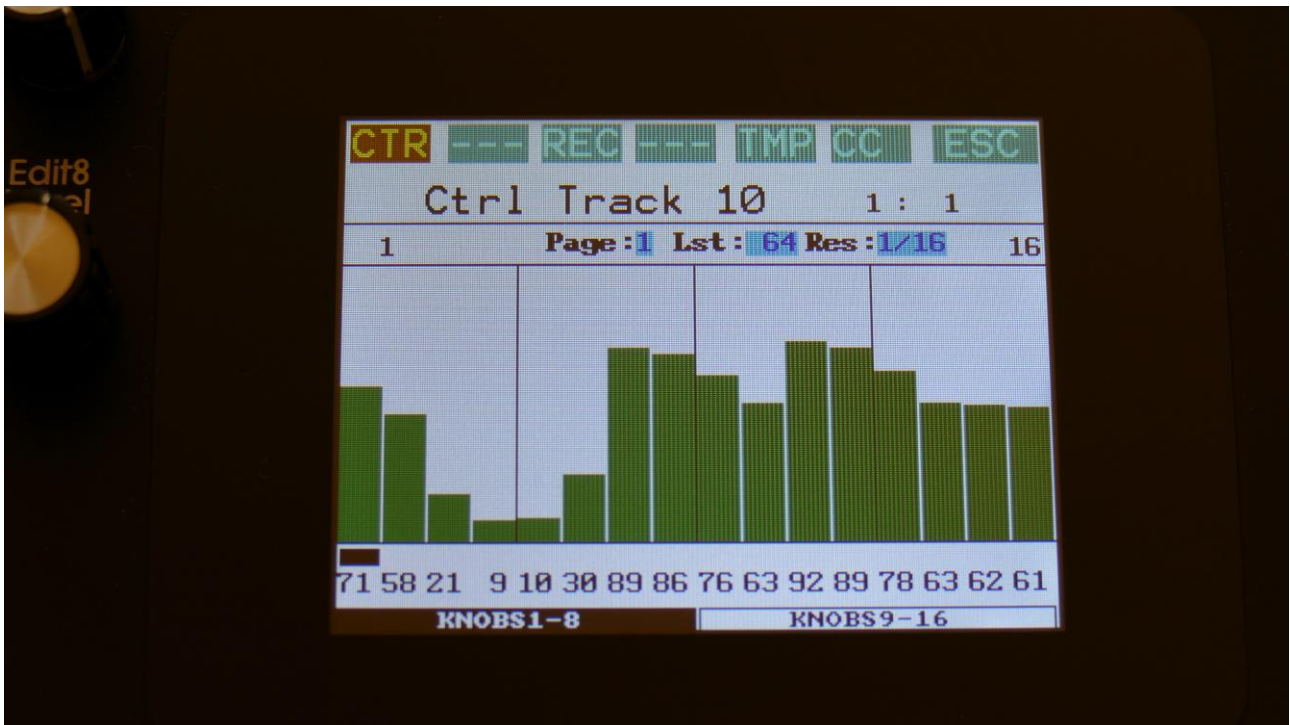

This will be the first page, you will enter, showing the controller values, that will be outputted for each sequencer step, when the sequencer is playing back.

At most of this screen, you will see the value grid. Right above this, to the left and to the right, the first and last step numbers, of the steps that is currently shown in the value grid, are indicated.

Between these numbers, a few settable parameters is shown.

In the top left side, a small VU-meter is shown, that show the value currently being outputted by the track.

Here, when neither KNOBS1-8 or KNOBS9-16 are black:

Edit Knob 1: Has no function.

Edit Knob 2: Selects the bar to be viewed. 4 bars can be viewed, showing each 16 steps, for a total of 64 steps. The bar number is shown just above the values field (marked **Page**), and the first and the last step number viewed, is shown just above the values field, to the right and the left.

Edit Knob 3: Sets the last step that will be played back on this track, before it loops back, and plays the track again. Range: 1 to 128 steps. Value is shown as **Lst**.

The Last step can be set globally for all tracks at the Seq Main page.

Edit Knob 4: Sets the track resolution. Values: 1/64, 1/48, 1/32, 1/24, 1/16, 1/12, 1/8, 1/6, ¼, ½. Value is shown as **Res**.

Touching “ESC” will exit you to the Sequencer Access page.

The controller values for each step is shown right below the value grid. If a black underscore is shown below the number, it means that the value are above 100. Controller values for each step can be changed, simply by touching the value grid.

Values can also be changed, using edit knob 1 to 8. In the bottom of the page, touch the field named “Knobs 1-8”, to edit the first 8 steps, using the edit knobs, or touch the field named “Knobs 9-16”, to edit the last 8 steps, using edit knob 1 to 8.

Key Grid Mode

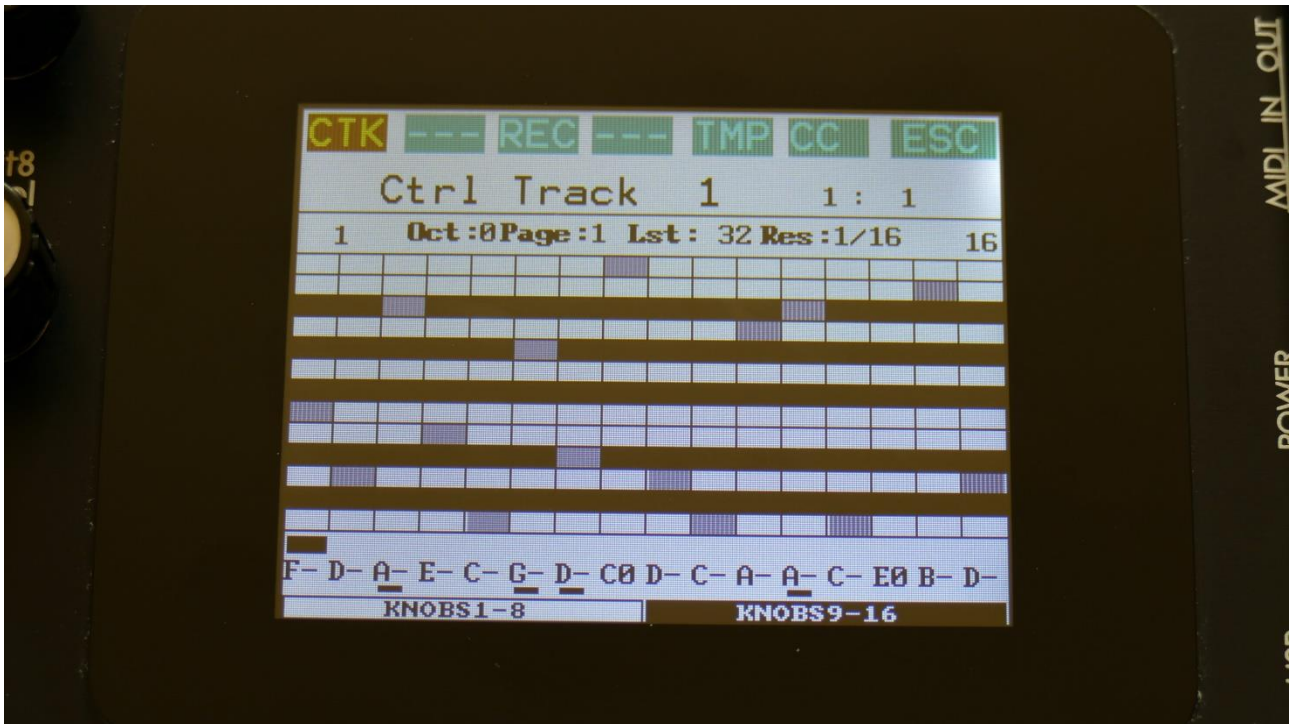

By touching the CTR/CTK field in the upper left corner of the controller track screen, this page will toggle between the value bars and a key grid.

The key grid mode will make it easier to program sequences for CV synths.

In order to make the key scaling fit, this should only be used in conjunction with the CV stepped quantized modes, explained under “Controller Tracks CC page”, a few pages later.

Controller Tracks Templates

Templates are available to make it easier to create ramps on a track and to randomize things. For the position track templ

When on either the Controller track step values page, touch TMP on the top navigation bar, to enter the templates page.

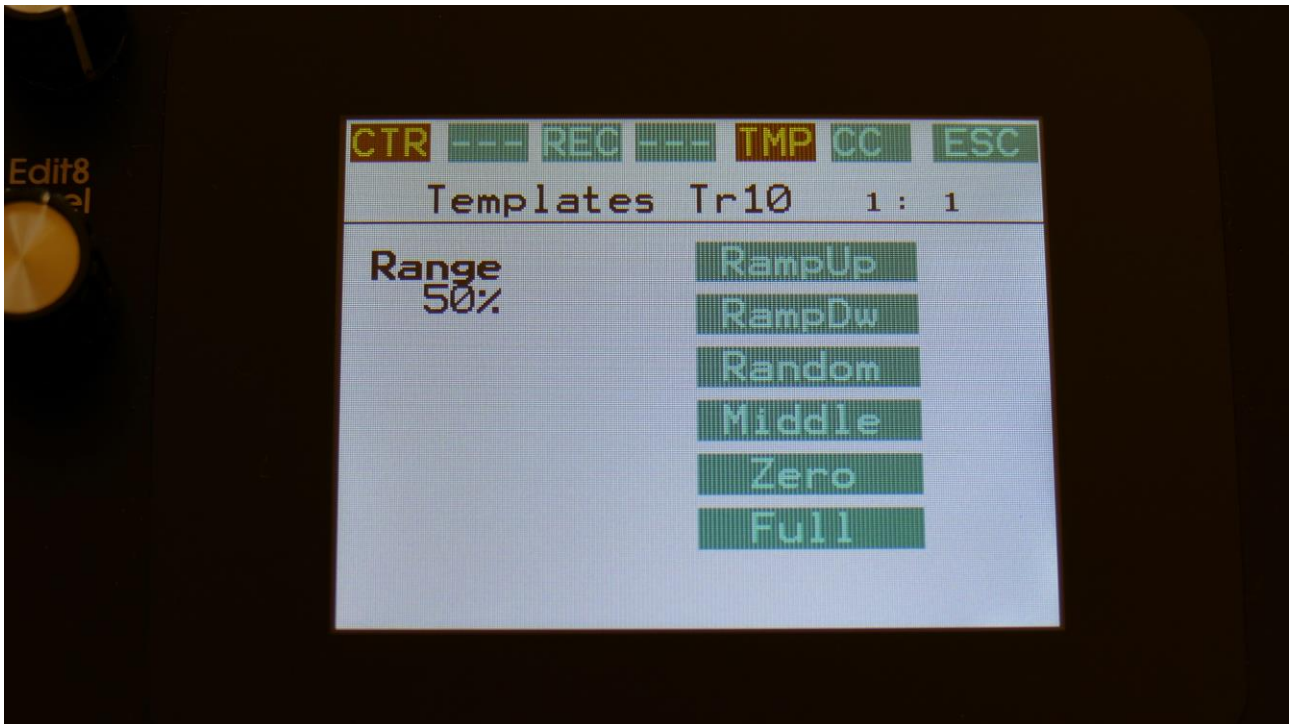

First turn Edit Knob 1, to set the range. This will set, how much the template routine will affect the values, that are already on the selected subtrack. When this is set to 100%, the template function will be absolute. Then touch any of the template boxes in the right side of the screen.

The templates work from step 1 to the last step that is set. Values after the last step are not affected.

Available templates:

- RampUp**: Ramp Up. Will lower values on steps, that are placed before last step divided by 2, and raise values on steps, placed after last step divided by 2.
- RampDw**: Ramp Down. Will raise values on steps, that are placed before last step divided by 2, and lower values on steps, placed after last step divided by 2.
- Random**: Will randomize all steps between step 1 and last step, to a degree set by the range parameter.

- Middle:** Will move any values closer to the middle value.
- Zero:** Will lower any values.
- Full:** Will raise any values.

Controller Tracks CC page

Touch CC in the top navigation bar, to enter this page.

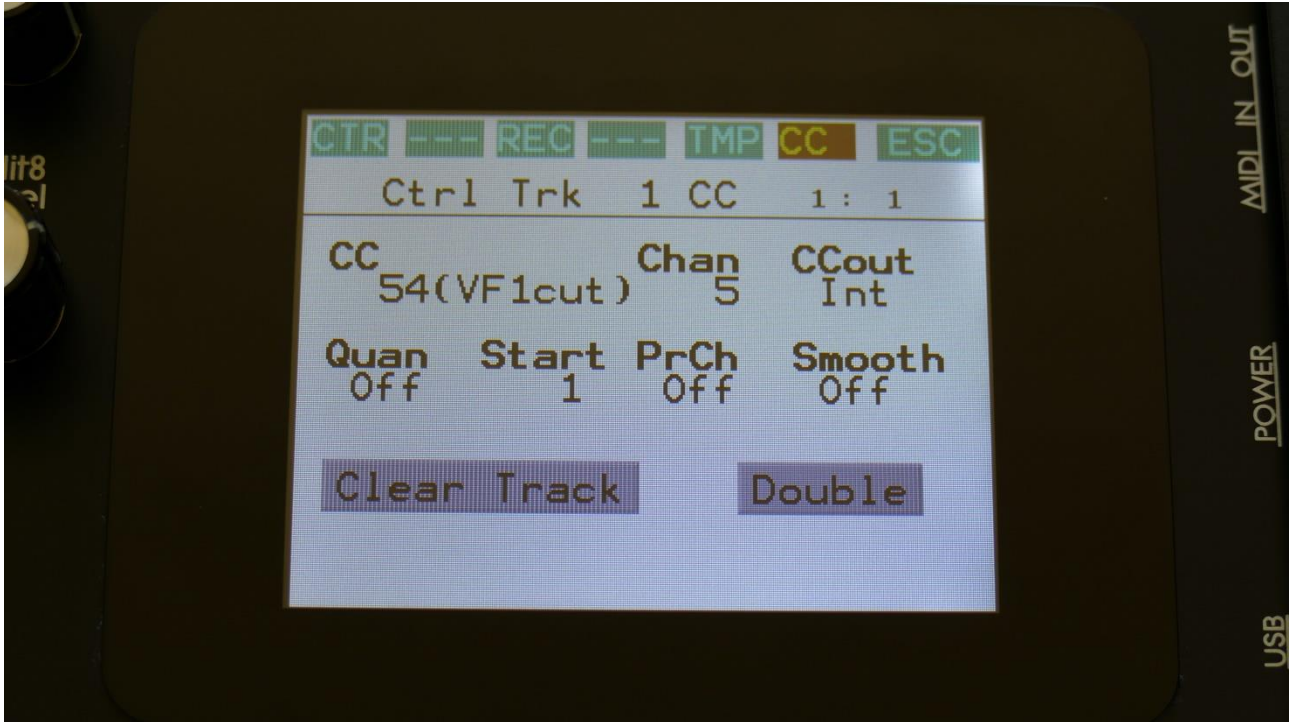

The parameters of this page:

CC: Off, 1(Morph), 2(SeqMrp), 3, 4(Knob1), 5(Knob2), 6, 7(Knob8), 8(Knob3), 9(Knob4), 10(Knob5), 11(Knob6), 12(Knob7), 13 to 15, 16 (Y-Mod), 17 to 122, CV IN 1 to 4, Pitch Bend. If the PccIN (Parameter CC's input) parameter on the MOR>COM2 page is turned on, it will also be possible to select many parameters for direct controller track control. The parameter names will be written in the parenthesis. Please see the list of parameter in the "MIDI Specs" section.

Setting this to any other value than "Off", will make the selected controller track output MIDI CC values or pitch bend values to MIDI out or internally, as set on the CCout parameter. When a number is set, this is the CC number that will be outputted. If any LD3 Edit Knob are assigned to this CC, the knob name will be written in parenthesis. If set to Pitch Bend, this is what will be outputted. The CC/Pitch Bend set here, are also the event that the track will realtime/step record. Controller track realtime and step recording are explained a little bit later.

Chan: 1 to 16. Sets the MIDI channel, that the selected MIDI CC will be transmitted to, when CCout is set to External, or the internal Synth Part number, that the CC's are sent to, when CCout is set to Internal.

CCout: Ext, Int. Sets if the controller track CC's/Pitch Bend's should be transmitted to an external MIDI device via MIDI Out (Ext), or to an internal Synth Part (Int). Regardless of this setting, the controller track are always available as internal modulation sources.

Quan: This can be set to either:

-Off: No quantization of the controller track output.

-1v: The whole value range of the output of the controller track is quantized to 1V per octave, when assigned as a source for the CV outputs.

-1.2v: The whole value range of the output of the controller track is quantized to 1.2V per octave, when assigned as a source for the CV outputs.

-1vS: Each value step of the controller track output represents one CV note, at 1v per octave, when assigned as a source for the CV outputs.

-1.2vS: Each value step of the controller track output represents one CV note, at 1.2v per octave, when assigned as a source for the CV outputs.

PLEASE NOTICE: The scaling of the CV quantization can be adjusted. Please see "Adjusting the CV scale" a few pages later.

Start: 1 to 128. Sets the track start step. This will be the step, the track starts at, when hitting the Start/Stop button, or when entering this preset from another preset, while the sequencer is running.

The Start step can be set globally for all tracks at the Seq Main page.

PrCh: Off, 1 to 128. When setting the PrCh parameter to any value between 1 and 128, a program change message will be transmitted on MIDI out, on the MIDI channel selected by the Chan parameter, every time this preset is selected. The CCout parameter has no effect on this. Each of the 32 controller tracks can transmit its own program change.

Smooth: Off, On. When this is set to On, extra controller values will be added between the controller value steps, to ensure smooth transition between these.

Clear Controller Track

From the track CC page, touch the **“Clear Track”** button, to enter this page:

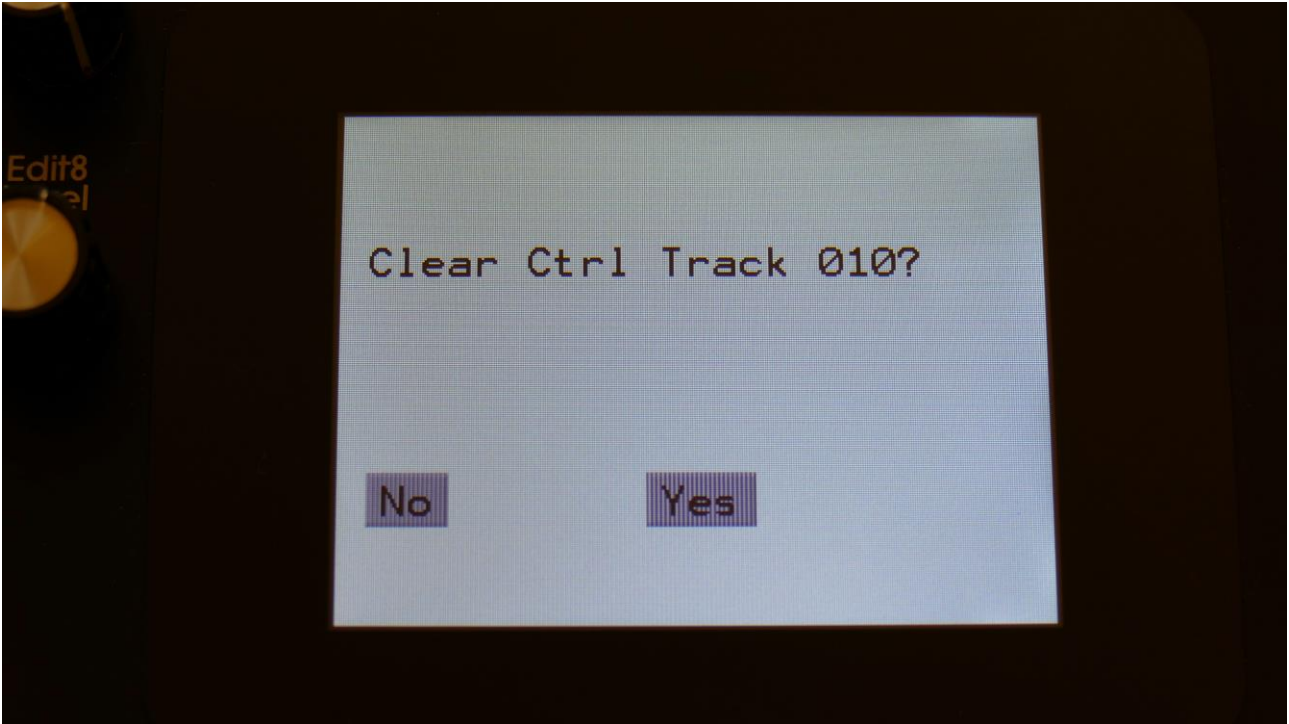

Touching **“Yes”** from here, will clear all step on's of the currently selected controller track.

If you would not wish to do this, touch **“No”**, to exit to the track main page.

Double Controller Track

Touch the “Double” touch button, to double the length of the track. All events from the original track, is copied to the new half. Useful if you need some extra variation in a track.

PLEASE NOTE: The controller track lengths cannot exceed 128 steps.

Adjusting the CV scale

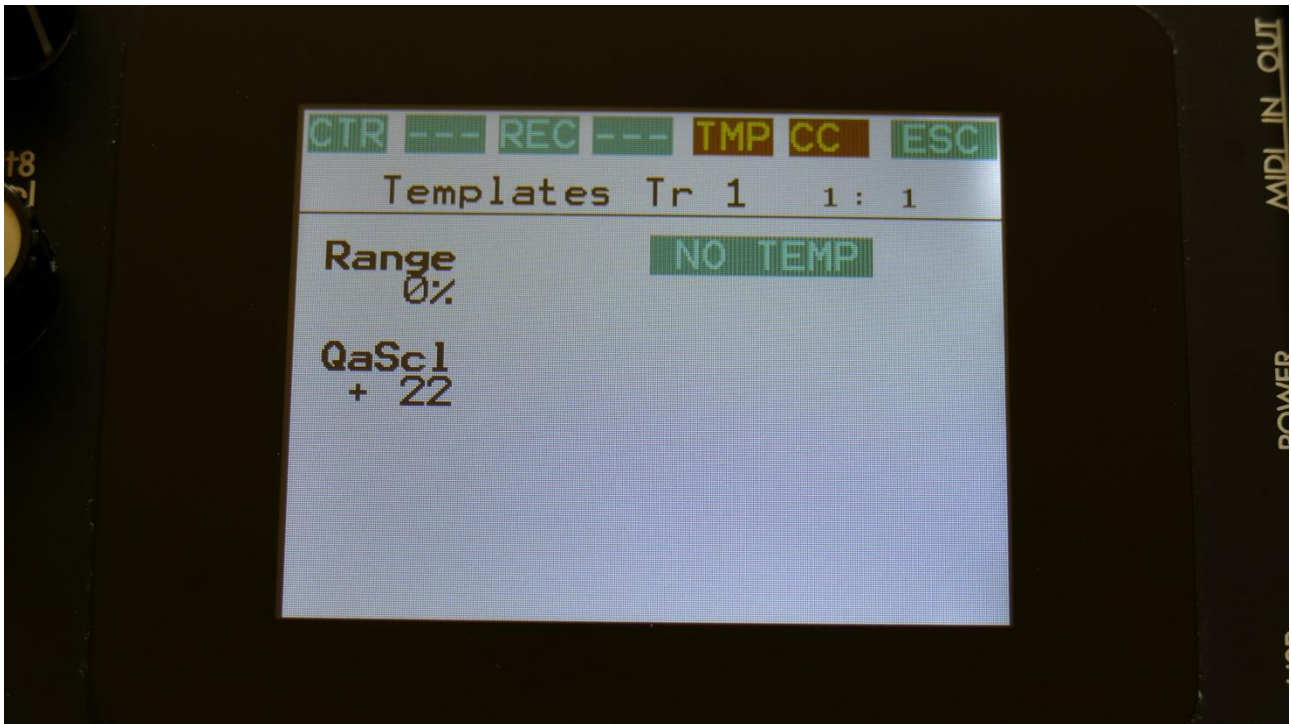

In case that your analog CV synth doesn't precisely fit to 1v/oct or 1.2v/oct, it is, on the controller track TMP page, possible to adjust the scaling, by tweaking the QaSc1 parameter.

Negative values will give a scaling less than 1v/1.2v/oct, positive values will give a scaling more than 1v/1.2v/oct.

This setting is adjusted per preset, and affects all controller tracks at the same time.

Controller Tracks Realtime Recording

MIDI CC's, Pitch Bend, CV Inputs and knob movements can be realtime recorded on the 32 controller tracks.

To do this, on the controller track CC page, set it to the event type, that you would like to record, using the CC parameter.

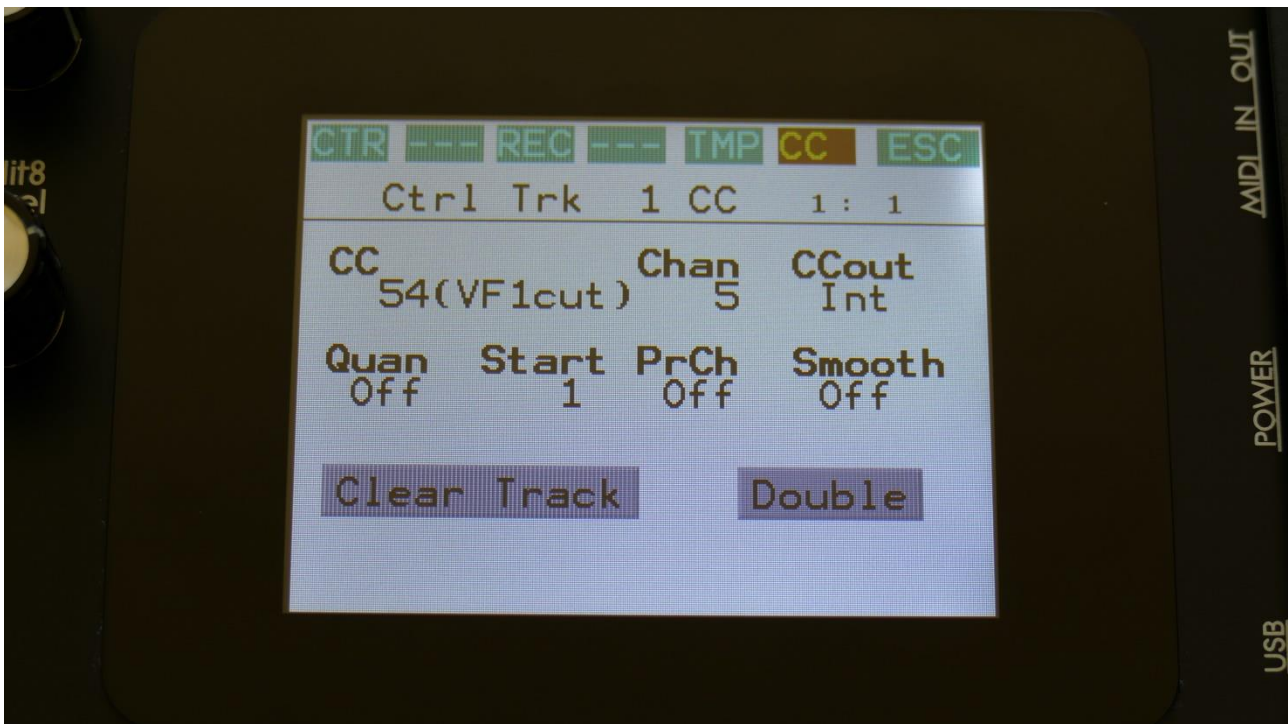

The CC parameter can be set to any MIDI CC between 1 and 122.

In the top position, you will find CV In 1 to 4 and Pitch Bend, and at position 16 (CC16), you will find the touch screen keyboard Y-position.

The MIDI CC used for knob movement recording are named like this:

- 1(Morph)
- 2(SeqMrp)
- 4(Knob1)
- 5(Knob2)
- 7(Knob8)
- 8(Knob3)
- 9(Knob4)
- 10(Knob5)
- 11(Knob6)

12(Knob7)

For knob movement recording, you should select one of these.

If the PccIN (Parameter CC's input) parameter on the MOR>COM2 page is turned on, it will also be possible to select many parameters for direct recording. The parameter names will be written in the parenthesis. Please see the list of parameter in the "MIDI Specs" section.

Set the track to the desired MIDI channel, using the Chan parameter. If the track is set to internal operation, the channel number is the part number, that the track will output to.

Set CCout to Int (internal) or Ext (external), depending on, if you like the controller track to control LD3 itself, or some external MIDI gear.

Touch REC on the top navigation bar, to enter this page:

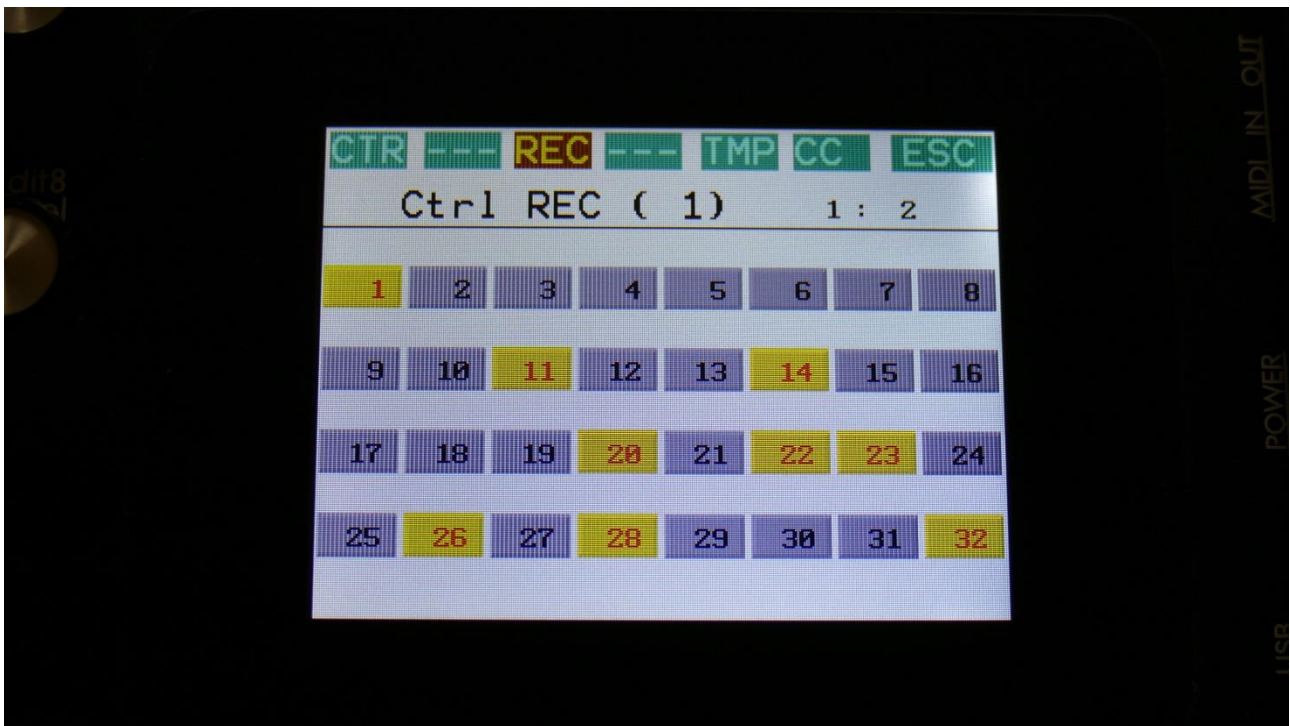

Select the controller track(s), that you would like to realtime record, by touching the square, that has the same number(s) as the track(s), so that these turns yellow. Now they are armed.

Set the length of the controller tracks(s), if desired.

Now set LD3 in sequencer recording mode, by touching the REC field on the sequencer main page or on the preset select page, so that it turns red, or push and hold the Func/Mute button, while pressing the Start/Stop button.

Start the sequencer. Tweak the knobs and/or MIDI CC's.

The controller tracks, that are set in record mode, will record until the track reaches the last step, and starts over again. Then recording will switch off.

As soon as the controller tracks are recording, the squares of the recording tracks will turn red.

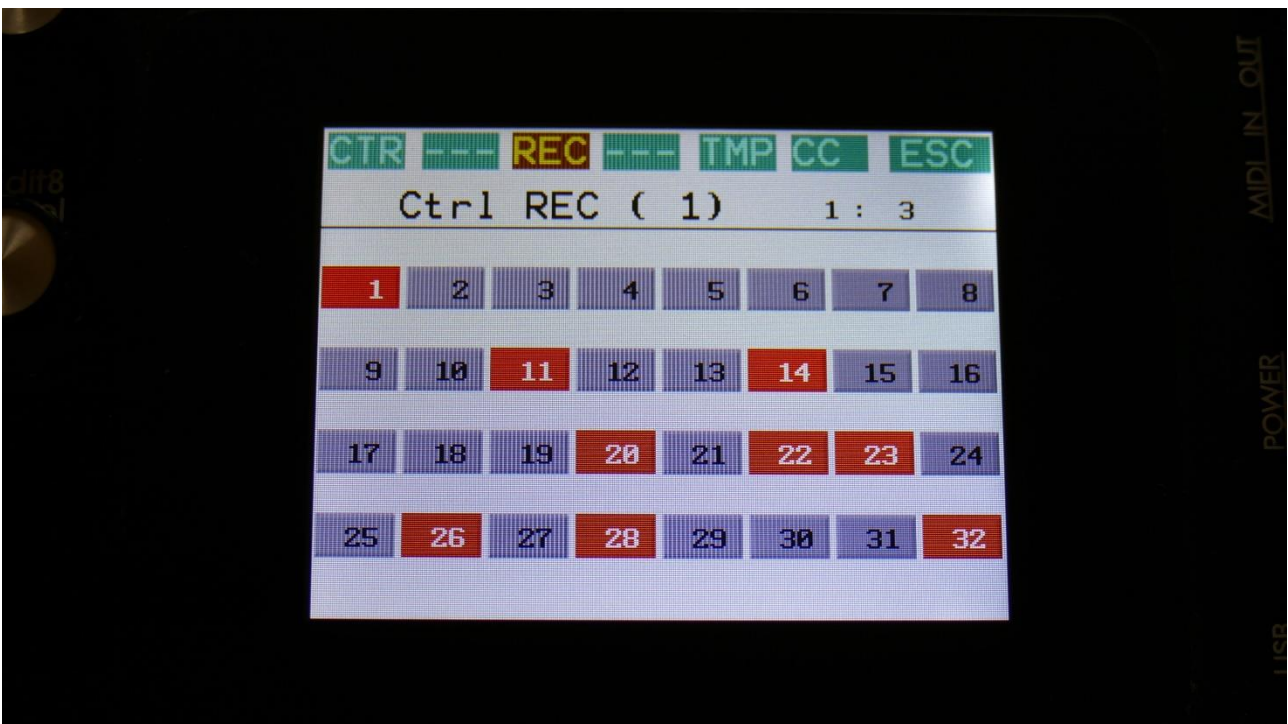

If the sequencer was running, when you switched the controller tracks into recording mode, they will stay armed (yellow), until the controller track passes step 1. Then they will switch to recording mode, and the squares will turn red, to indicate that.

When a controller track reaches its last step, recording will stop, and its square will turn grey.

Recording parameter tweaks to a controller track

First, set up the controller track, as described on the previous pages of this manual.

Stop the sequencer, if it is running.

Touch REC in the upper menu bar. Activate recording for the selected controller track.

Go to the CTR page, and set the controller track length.

Now, go to the Synth section page and select the part, where the parameter is located.

Put LD3 in realtime recording mode, by holding down the Part/Mute button, while pressing the Start/Stop button.

Press the Start/Stop button, to start the sequencer.

It will now count in for 2 bars, and the start to record. Tweak the parameter.

When the controller track reaches its end step, recording will stop, and the controller track will start to play back. You will now see the parameter value move by itself!

CV Inputs Recording

The 4 (optional) CV inputs can also be recorded to the sequencer controller tracks, just like MIDI CC's and knob movements.

To do this, simply select CV In 1 to 4 to be the CC on a controller track, and follow the procedure for controller track realtime recording.

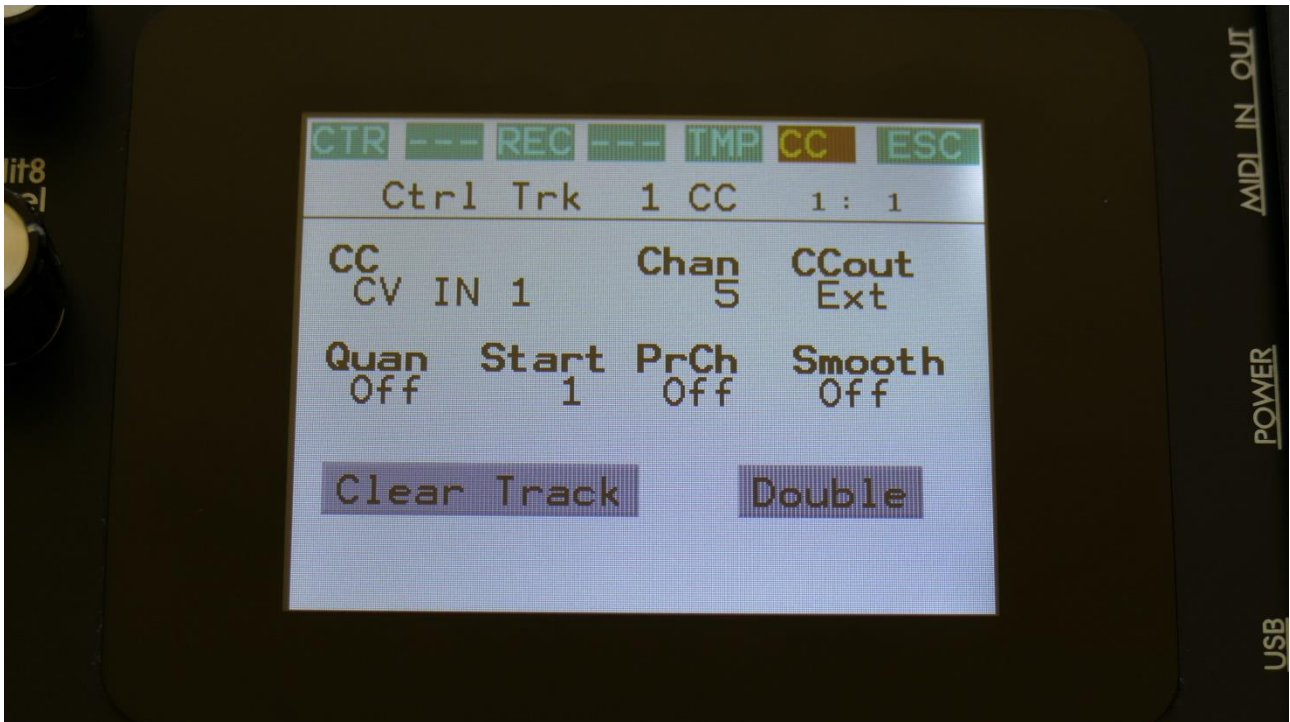

You will, most probably, like to switch the Smooth parameter On, to get smooth transitions between the recorded CV values.

Pitch Bend and CC recording auto setup

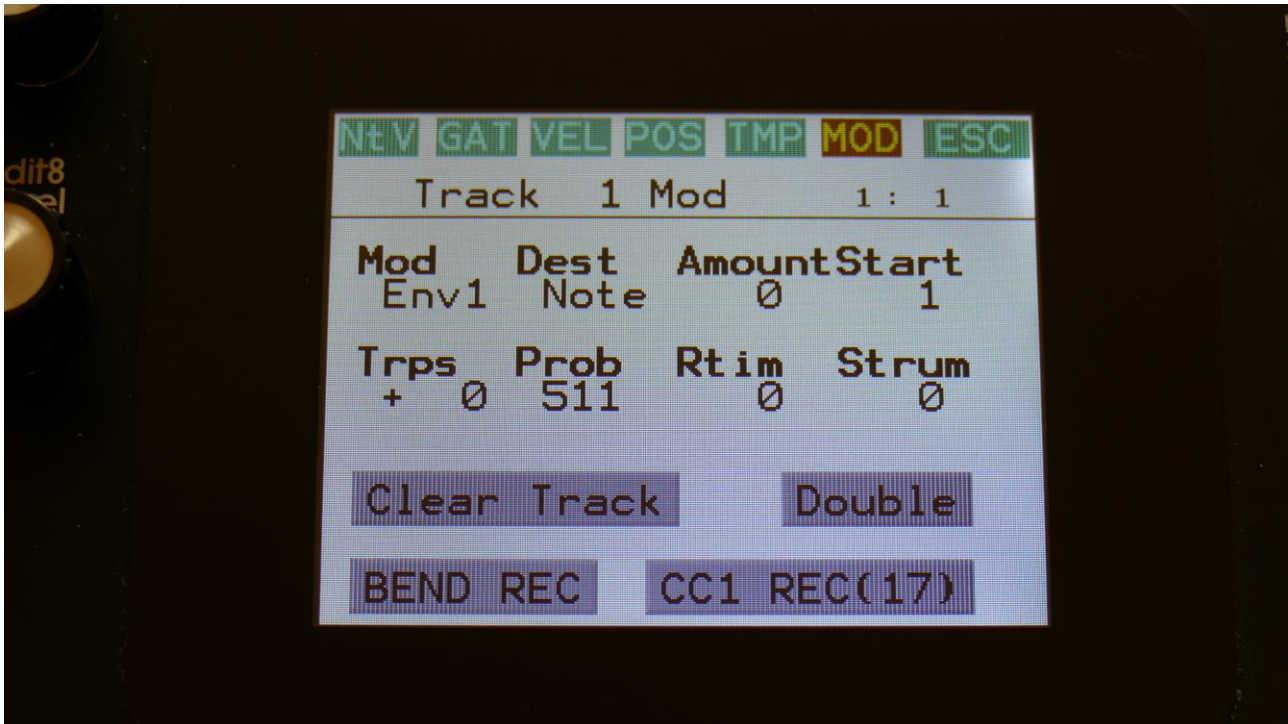

From the sequencer note track Mod pages, it is also possible to make LD3 automatically set up controller tracks to realtime record pitch bend and CC events.

When using this function, the controller track is set to the double resolution as the note track, and therefore also the double length, to make the tracks match.

Note track 1 will set up controller track 1 for pitch bend recording and controller track 17 for CC recording.

Note track 2 will set up controller track 2 for pitch bend recording and controller track 18 for CC recording.

-
-
-

Note track 16 will set up controller track 16 for pitch bend recording and controller track 32 for CC recording.

The CC number to be recorded, will be the CC number, that the controller track is already set to. If the controller track is not already set to a CC number, CC1 will be recorded.

To initiate Pitch Bend recording

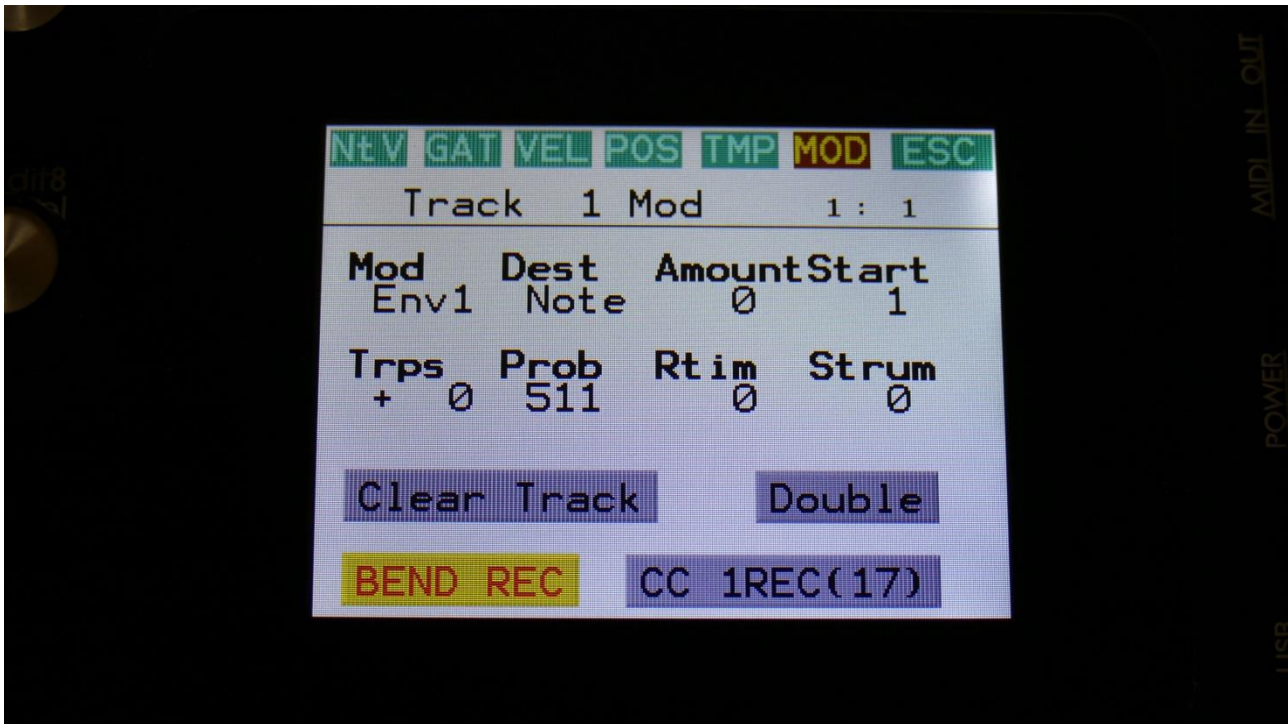

- Make sure that sequencer realtime recording is switched off.
- Set the desired length and resolution of the note track.
- Go to the Mod page, and touch BEND REC, so that it turns yellow.
- Start realtime recording.
- If the sequencer is already running, recording will start, when the controller track passes step 1. The Bend Rec touch button will then turn red, to indicate that recording is active.
- Pitch Bend messages will only be recorded the first time, the controller track is running. When the controller track passes its last step, recording will be switched off, and the Bend Rec touch button will turn grey.

Follow the same procedure, to record CC events, plus set the desired CC number on the controller track.

Controller Tracks Step Recording

It is also possible to step record controller events.

To initiate step recording:

- Set the controller track in realtime recording mode, as described in a previous chapter.
- Start the sequencer playback, if desired. Step recording is possible no matter if the sequencer is running or not.
- Push and release the Steps/Part button, so that it lights up, and puts the 16 step buttons in step mode.
- Push the step button, that has the position for the step, that you would like to record. This will now flash.
- An armed controller track rec indicator (yellow), will now switch to recording mode (red).
- Set the Knob/MIDI Controller to the value, you would like this step to hold.
- Select another step to record.

Synth and Sequencer Morphing

On LD3 it is possible to morph between 2 layers of parameters, layer A and B, by turning the Morph knob for the synth parameters, and the Seq Morph knob for the sequencer parameters. The Morph knob transmits and receives MIDI CC 1 (The Mod Wheel) via MIDI in and out, and the Seq Morph knob transmits and receives MIDI CC2.

To access the parameters of the second layers, on any synth and sequencer page, hit the Morph Set button, so it lights up. Now the parameters of layer B will be shown on the screen, and you can edit these, using Edit Knob 1 to 8, just like the layer A parameters.

All continuously adjustable parameters can be morphed. Switches are not morphed, except for the note tracks steps on/off.

In the MOR section under MORPH, it is possible to set static Morph knob values, and to modulate the morph knobs.

All morph settings are stored within each Preset. Remember to save the Preset, to not loose any great sounds.

More... preset parameters/Setup

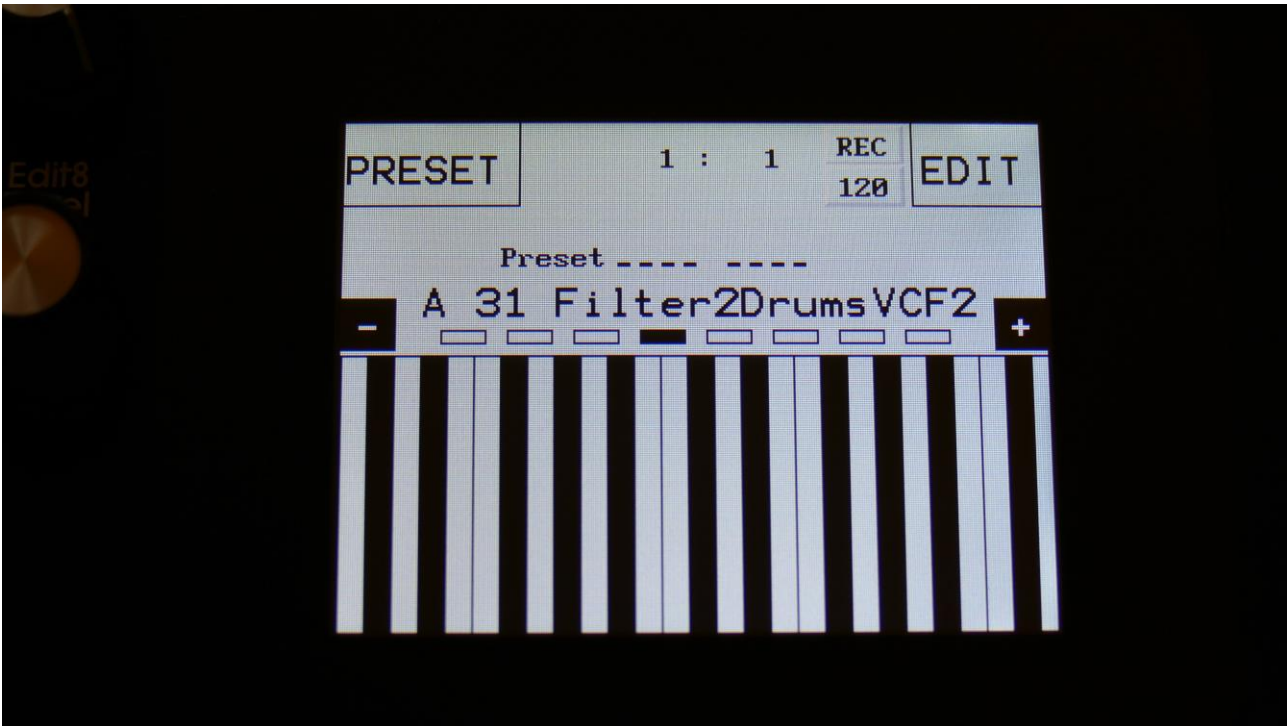

From the Preset Select page, touch the Edit field.

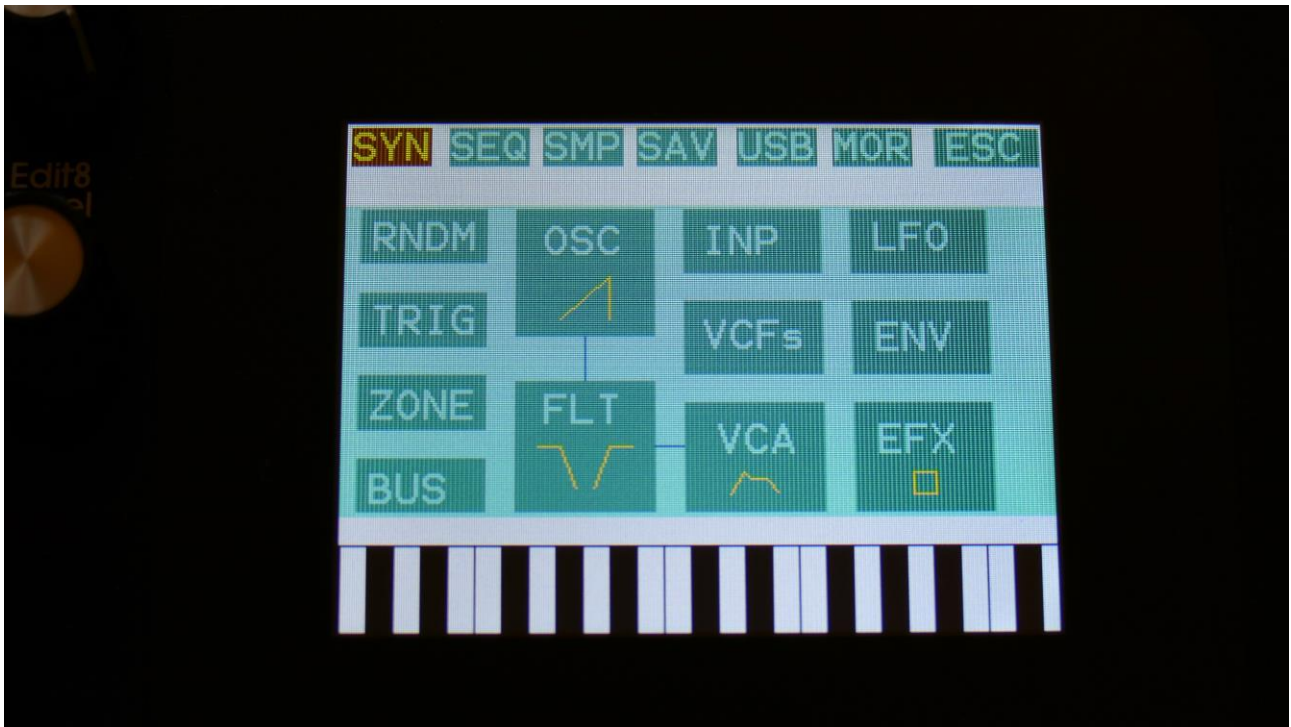

On the navigation bar at the top of the screen, touch MOR.

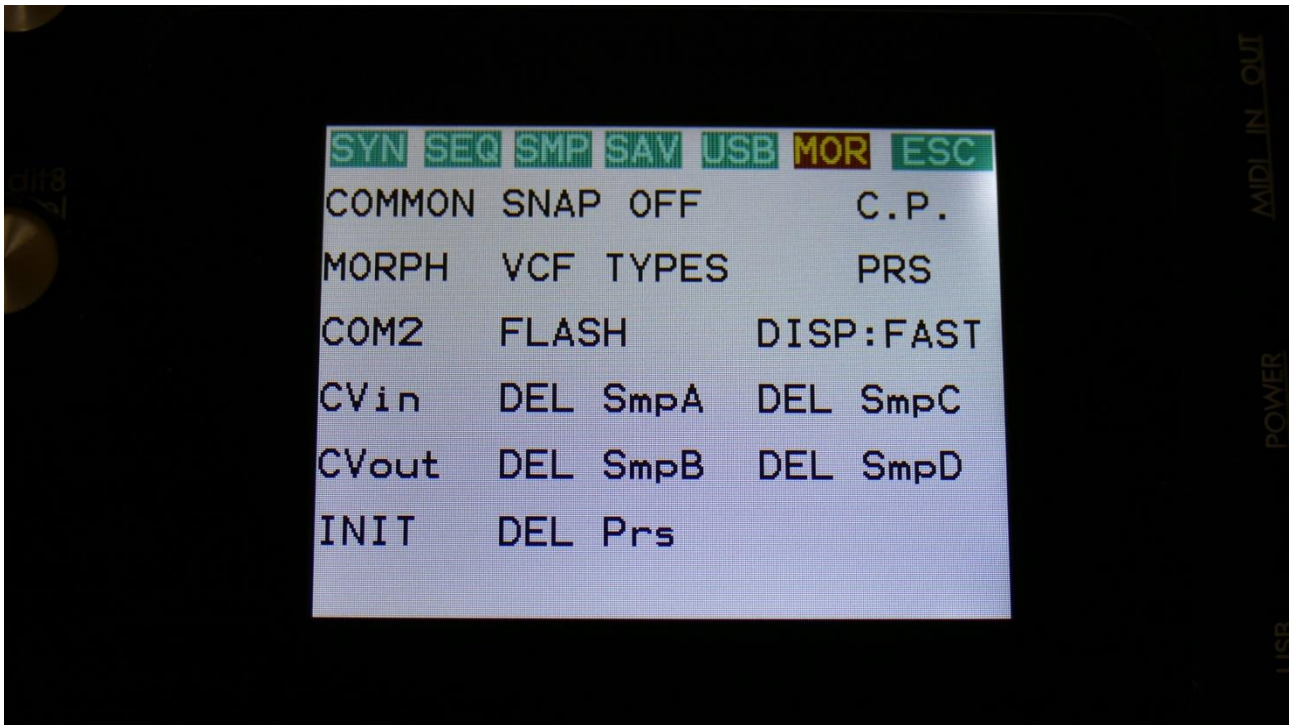

This will get you to the More... page. Here you can set up all the basic LD3 things, like global MIDI channel, morphing and CV in's/out's, setup FilterBoard types, check and erase the LD3 memory, initialize the preset and change to song mode.

On the following pages, each section of the More... page is described.

Common Settings

On this page, you can adjust the display contrast and MIDI settings and check the sample memory.

From More... page, touch COMMON to enter this page:

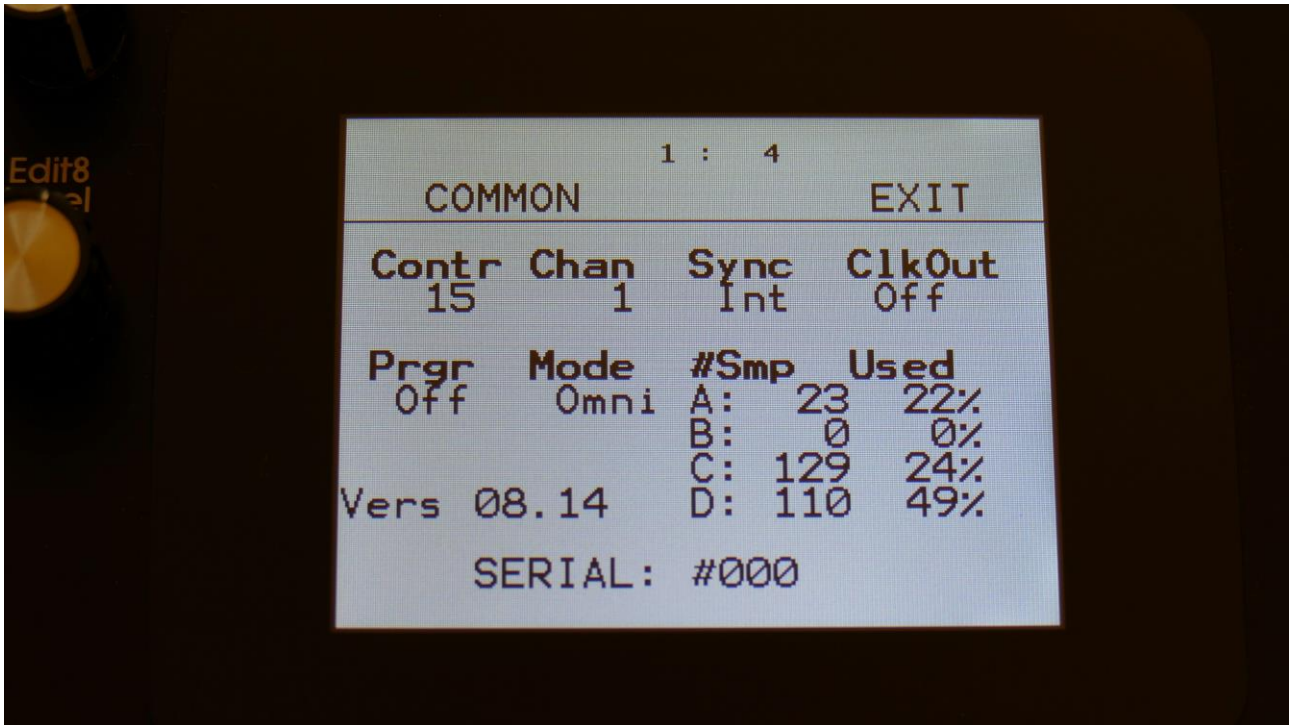

The following parameters can be adjusted on this page, using edit knob 1 to 8:

Contr: Adjusts the display contrast. This setting is automatically saved, and will be remembered after a power off.

Chan: The LD3 global MIDI channel. All MIDI data to LD3 will be received on this channel, if the Mode parameter is set to Sel (Explained in a moment). MIDI CC's from the Edit/Quick Edit Knobs and the Morph knob will be transmitted on this channel, if the Mode parameter is set to Sel. This setting is automatically saved, and will be remembered after a power off.

Sync: Sequencer synchronization. This setting is automatically saved, and will be remembered after a power off. Settings:

-**Int:** LD3's sequencer will be clocked internally at the rate set by the "Tempo" parameter in each preset.

-**Ext:** LD3's sequencer will be clocked externally, by MIDI clock events applied to MIDI in. Sequencer play and stop can also be controlled externally.

ClkOut: Settings: Off, On. Selects whether or not LD3 will re-transmit MIDI clock and start/stop events to MIDI out. Even if LD3 is syncing to an external MIDI clock source, it will re-transmit this, if this parameter is on. This setting is automatically saved, and will be remembered after a power off.

Prgr: On/Off. When switched on, LD3 will receive MIDI program and bank changes. Bank change is MIDI CC 32.

Mode: LD3 MIDI input mode. This setting is automatically saved, and will be remembered after a power off. Can be set to:

-**Sel:** The selected synth part is controlled on the LD3 base MIDI channel.

-**Omni:** The selected synth part is controlled on any MIDI channel.

-**OmTh:** Omni Thru. The selected synth part is controlled on any MIDI channel. MIDI events are channelized to MIDI out on the MIDI channel selected on the Synth Part TRIG page.

-**Mult:** Multi timbral. All 16 parts works in multi timbral mode, and is controlled by the MIDI channel/key range set on each parts ZONE page.

-**MuTh:** Multi timbral/Thru. All 16 parts works in multi timbral mode, and is controlled by the MIDI channel/key range set on each parts ZONE page. MIDI events are channelized to MIDI out on the MIDI channel selected on the Synth Part TRIG page.

#Smp: Shows how many samples that are held in sample bank A, B, C and D.

#Used: Shows in percent how much of the sample memory of each sample bank is occupied by samplings.

In the bottom of this screen, the currently installed firmware version number is shown, and the serial number for your LD3.

Morph Setup

On the Morph Setup page, it is possible to set a permanent morph value, that will override the Morph knob, if you wish to always have a preset playing back in a certain morph position.

It is also possible to modulate the morph knobs, using a limited number of modulation sources, including a morph LFO.

From More... page, touch MORPH to enter this page:

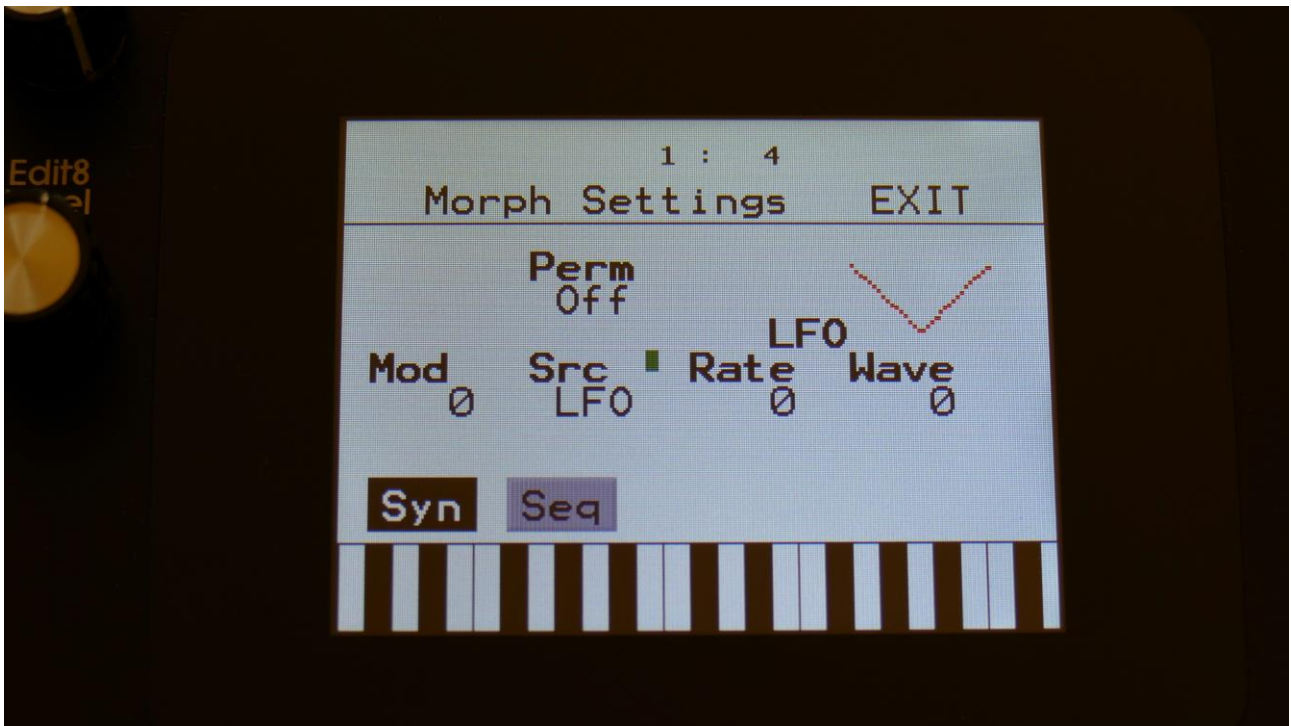

This is the settings for the Morph knob, that affect the Synth Parts, LFO's and effect processors. Touch the Syn touch button, to access this page.

Parameters on this page:

Perm: Morph knob permanent value. Will override the value of the Morph knob, and keep morph on the permanent value plus modulation. Range: Off, 1 to 511.

Mod: Morph knob modulation amount. 0 to 511.

Src: Morph modulation source. Sources are:

-**LFO:** The morph section LFO. Described below.

-**Seq1 to Seq8:** Sequencer controller tracks 1 to 8.

-**CV1 to CV4:** CV inputs 1 to 4.

-**Kybd:** The last note number value received

-**Velo:** The last note velocity value received

-**TouY:** Touch screen keyboard Y position.

Rate: Morph LFO rate. Sets the tempo of the morph section LFO, that can only modulate the morph parameter.

Wave: Morph LFO output waveform. Morphs between triangle, sawtooth, square, pulse and FM waveforms. The FM waveforms are high frequency waves, that can be used for FM synthesis.

Sequencer Morph Knob Setup

Touch the Seq touch button, to enter this page.

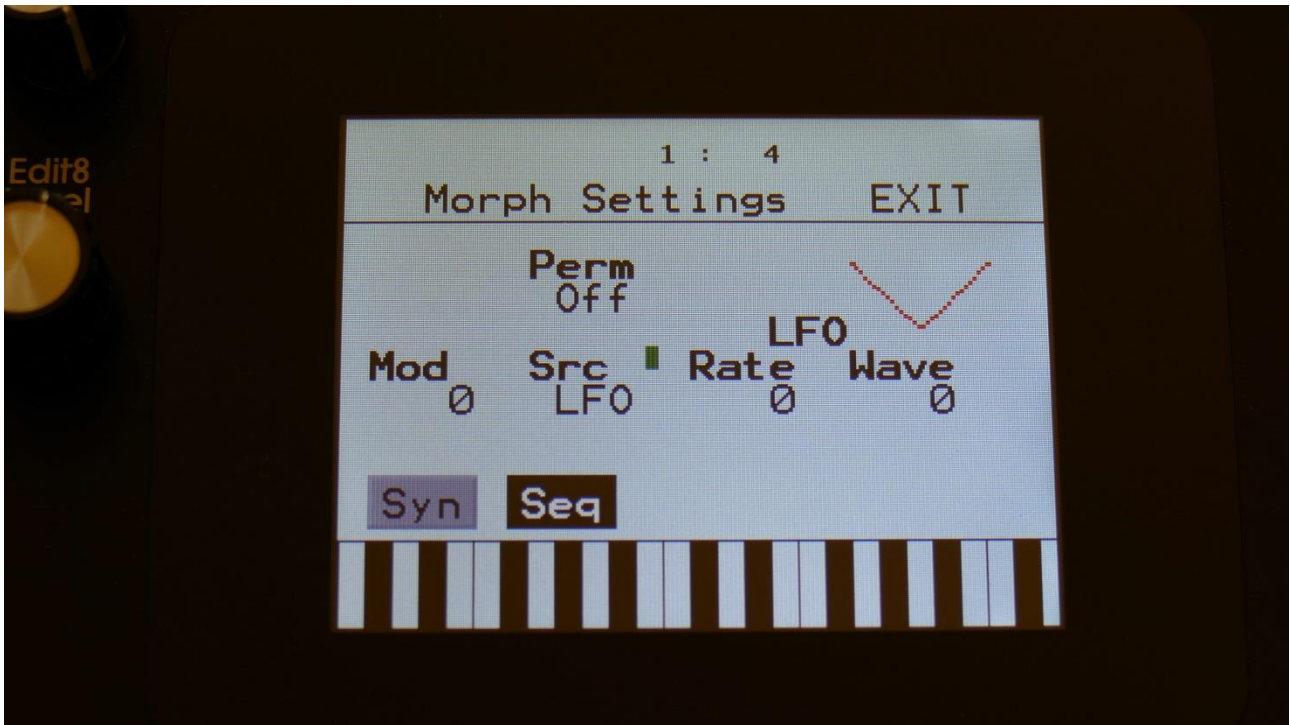

This is the settings for the Seq Morph knob, that affect the Sequencer.

Parameters on this page:

Perm: Seq Morph knob permanent value. Will override the value of the Seq Morph knob, and keep morph on the permanent value plus modulation. Range: Off, 1 to 511.

Mod: Seq Morph knob modulation amount. 0 to 511.

Src: Seq Morph modulation source. Sources are:

- LFO:** The morph section LFO. Described below.
- Seq1 to Seq8:** Sequencer controller tracks 1 to 8.
- CV1 to CV4:** CV inputs 1 to 4.
- Kybd:** The last note number value received
- Velo:** The last note velocity value received
- TouY:** Touch screen keyboard Y position.

Rate: Seq Morph LFO rate. Sets the tempo of the morph section LFO, that can only modulate the morph parameter.

Wave: Seq Morph LFO output waveform. Morphs between triangle, sawtooth, square, pulse and FM waveforms. The FM waveforms are high frequency waves, that can be used for FM synthesis.

Common Settings 2 (COM2)

On this page you can set if the part select and part mute buttons should latch or not, and if LD3 should receive parameter MIDI CC's.

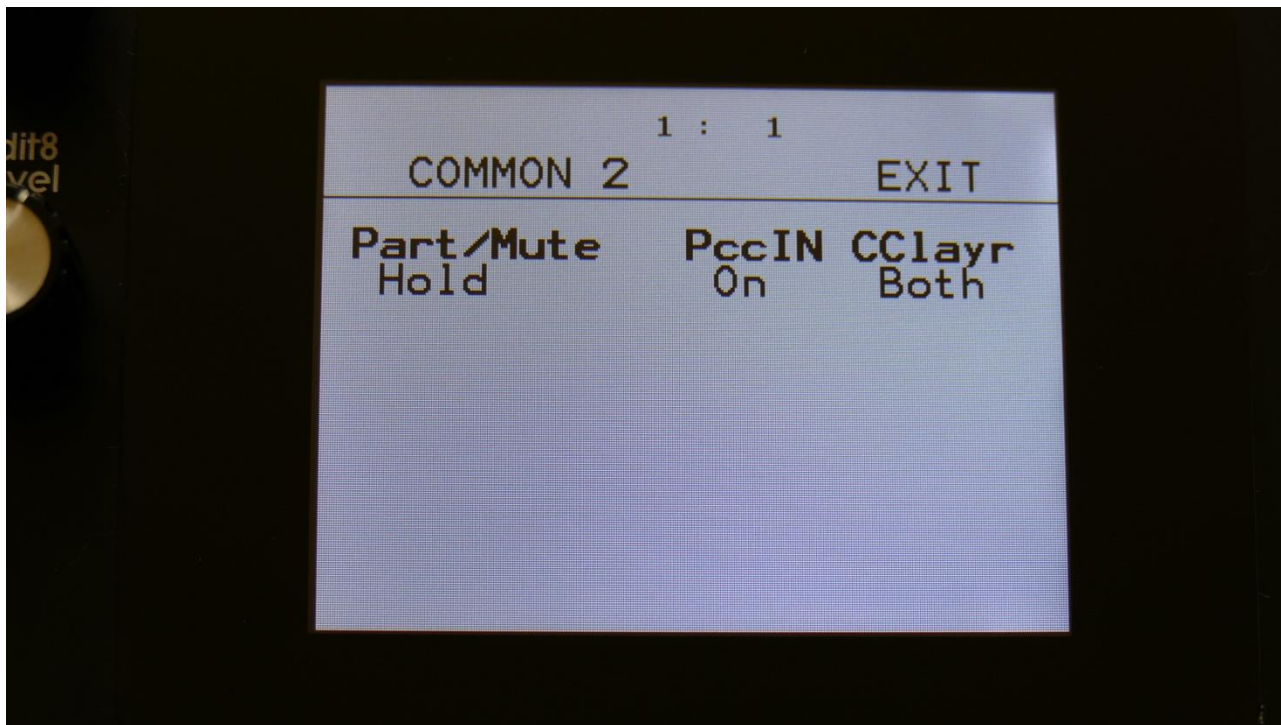

Here you can, by rotating Edit Knob 1, set the **Part/Mute** button to:

-Hold: You will have to hold the Func/Mute or Steps/Part buttons, while pushing a step button, to select or mute a part.

-Latch: When pushing and releasing either the Func/Mute or the Steps/Part buttons 2 times, the button will start to flash, and you can select or mute parts, by pushing the step buttons. It is still possible to select and mute parts, by holding any of these buttons.

PccIN: Off, On. Parameter CC Input.

If this parameter is set to On, many of the LD3 parameters will be hard-assigned to MIDI CC numbers. This also makes it possible to control the same parameters directly from the sequencer controller tracks, and to realtime record parameters tweaks on the controller tracks.

For a complete list of controllable parameters, please see the “MIDI Specs” section of this manual.

CClayr: CC control to Morph Layer. Sel, Both.

Sel: Only the Morph layer selected by the Morph Set button, will be affected by MIDI in and Sequencer CC control.

Both: Both Morph layers will be affected by MIDI in and Sequencer CC control, at the same time.

CV Inputs (optional)

With the optional analog board and CV inputs/outputs board installed, LD3 gets 4 CV inputs. These can be selected as modulation sources, for any parameter that can be modulated.

LD3 accepts CV voltages of up to +/- 15 volts. The voltage range of each CV input can be set up to a number of different configurations.

It is also possible to set up each CV input as a trigger for any of the 16 synth parts of LD3, and to set them up as clock sources, start/stop and reset control for the sequencer.

By setting a CV input up to trigger a part, and using another CV input to modulate the Part Trigger Note, CV/Gate to MIDI is possible.

Remember to save all edits you do to the CV Inputs. Else they will be lost when you change preset, or turn LD3 off. See how to in the "Save Preset" section.

From More... page, touch CVin to enter this page:

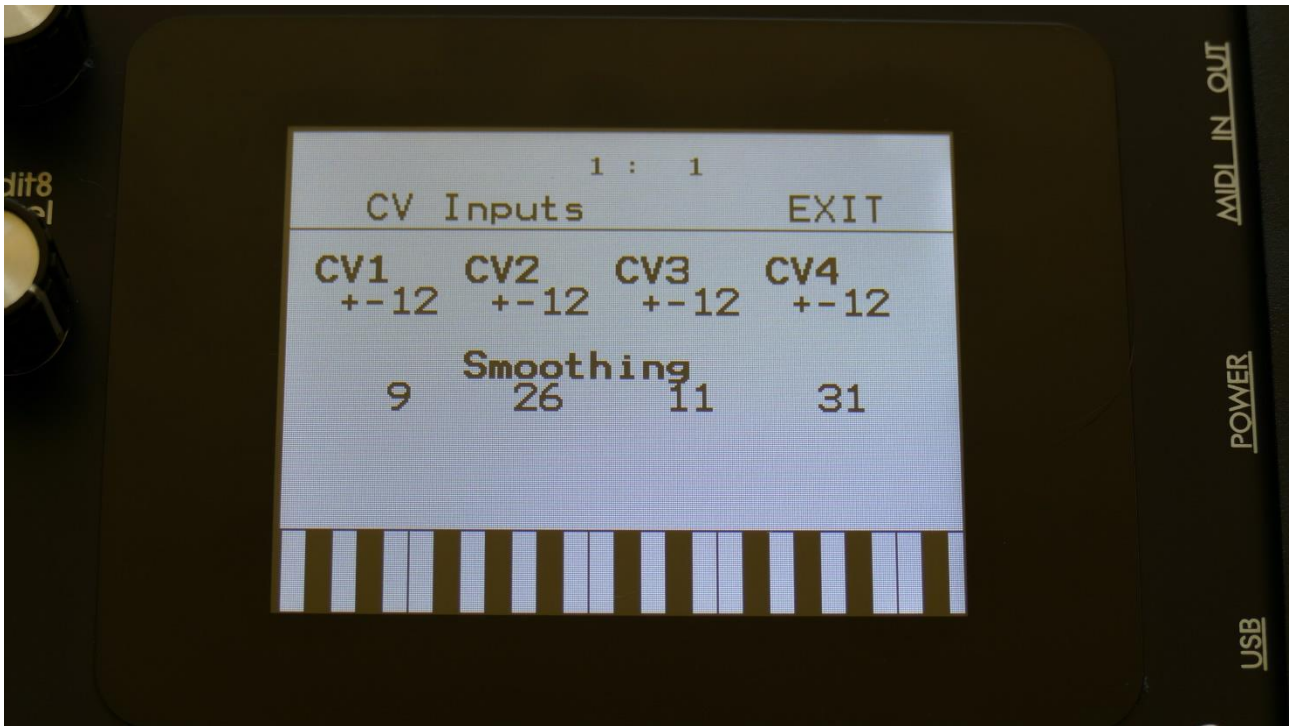

Here you can, by turning Edit Knob 1 to 4, set up each CV input. The possibilities for each input are:

+/-12: The CV input will work in the range of +/- 12 volts –standard eurorack voltages.

+12: The CV input will work in the range of 0 to 12 volts.

+/-5: The CV input will work in the range of +/- 5 volts.

+5: The CV input will work in the range of 0 to 5 volts.

Trg1 to Trg16: The CV input will work as a trigger input for Synth Part 1 to 16. As a modulation source, it will work in the +/- 12 volts range.

1/32: For each pulse it receives, the sequencer will increment 1/32 step. The internal sequencer clock, and any MIDI clock will be ignored. MIDI clock will still be transmitted, if the ClkOut parameter in the COMMON menu is set to on.

1/24: For each pulse it receives, the sequencer will increment 1/24 step. The internal sequencer clock, and any MIDI clock will be ignored. MIDI clock will still be transmitted, if the ClkOut parameter in the COMMON menu is set to on.

1/16: For each pulse it receives, the sequencer will increment 1/16 step. The internal sequencer clock, and any MIDI clock will be ignored. MIDI clock will still be transmitted, if the ClkOut parameter in the COMMON menu is set to on.

1/12: For each pulse it receives, the sequencer will increment 1/12 step. The internal sequencer clock, and any MIDI clock will be ignored. MIDI clock will still be transmitted, if the ClkOut parameter in the COMMON menu is set to on.

1/8: For each pulse it receives, the sequencer will increment 1/8 step. The internal sequencer clock, and any MIDI clock will be ignored. MIDI clock will still be transmitted, if the ClkOut parameter in the COMMON menu is set to on.

1/6: For each pulse it receives, the sequencer will increment 1/6 step. The internal sequencer clock, and any MIDI clock will be ignored. MIDI clock will still be transmitted, if the ClkOut parameter in the COMMON menu is set to on.

s/s: Will make the sequencer start or stop every time it receives a pulse or a gate on that input.

Rst: Will make all tracks of the sequencer reset to their respective start step every time a pulse or a gate is received on that input.

Smoothing: If the CV inputs sounds unstable, they can be smoothed out by turning up this smoothing parameter.

CV Outputs (Optional)

With the optional analog board and CV inputs/outputs board installed, LD3 gets 4 CV outputs.

PLEASE NOTICE: IF YOU HAVE SPAZEboard2 INSTALLED, THE PARAMETERS ON THESE PAGES WILL HAVE NO EFFECT AT ALL. The CV outputs of SPAZEboard 2 are controlled by the analog VCF3 parameters. Please see the SPAZEboard2 section of this manual, regarding this.

From each of these it is possible to control external analog gear with both a static voltage and a modulation source at the same time. The setup of these are stored within each LD3 preset, so it is possible to give the external analog gear memory!

Remember to save all edits you do to the CV Inputs. Else they will be lost when you change preset, or turn LD3 off. See how to in the "Save Preset" section.

From More... page, touch CVout. Touch the P_1 button to enter this page:

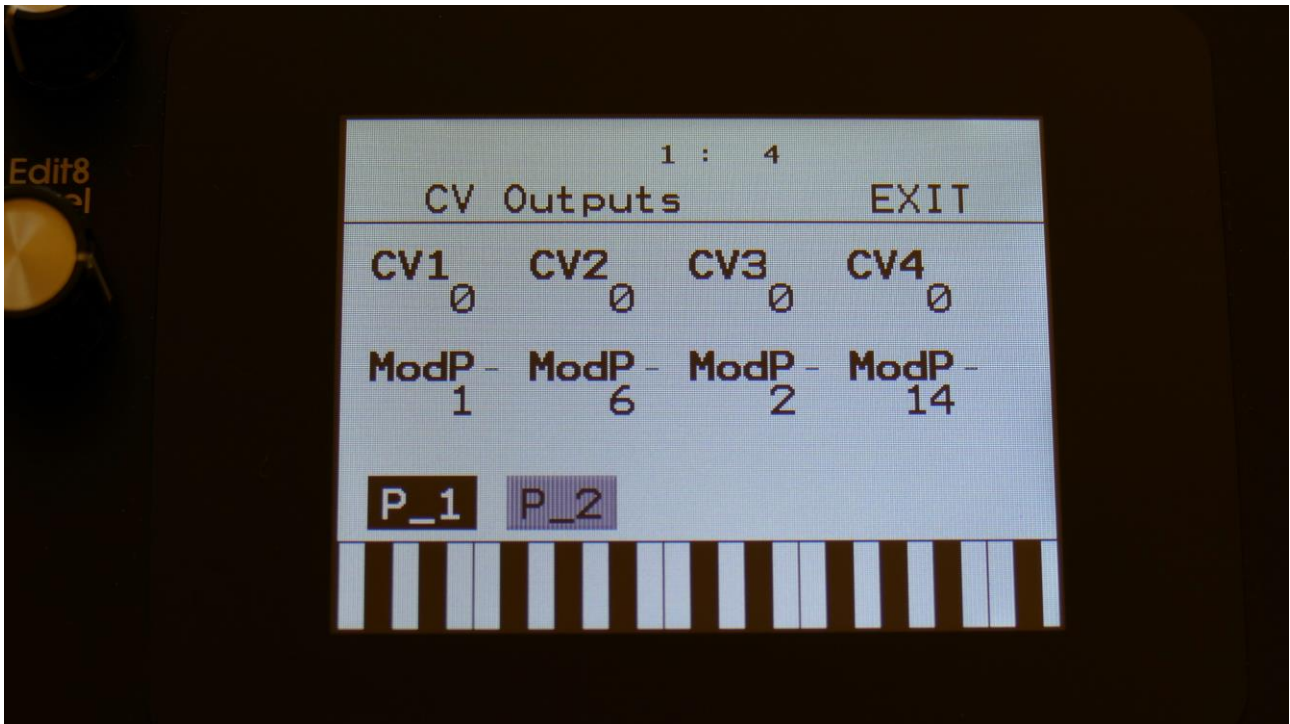

On this page the upper row of parameters (Edit Knob 1 to 4), sets a static voltage to each CV output. This is useful, if you for instance, are controlling cutoff or resonance of an external filter, or tune of an external oscillator.

On the lower row of parameters (Edit Knob 5 to 8), you can set the part, that should apply the modulation sources for each of the CV outputs.

CV Outputs Modulation

Touch the P_2 button, to enter the CV outputs modulation page:

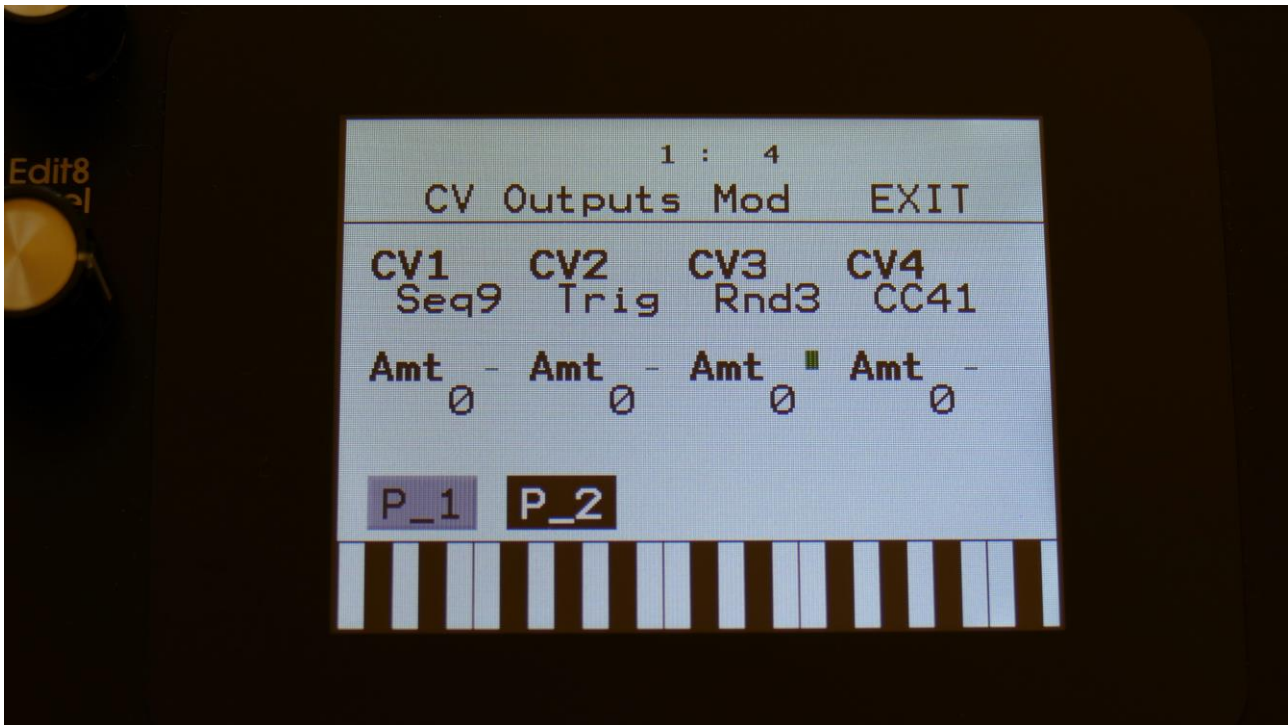

Here you can, by the upper row of parameters (Edit Knob 1 to 4), select the modulation source for each CV output. Only the positive modulation sources, can be selected by the Edit Knobs. To make a modulation source negative, touch the modulation source parameter. For a complete list of modulation sources, see the list in the start of the synth part section in this manual.

To generate an analog trigger on a CV output, select Trig as the modulation source. To generate a 1v/oct or 1.2v/oct oscillator CV, select a sequencer controller track as the modulation source, and set this up to quantize its output.

By lower row of parameters (Edit Knob 5 to 8), you can adjust the modulation amount for each CV output.

Initialize Preset

If you would like to start out from scratch, with a completely clean preset, this is the function to use.

Please notice that the preset on the selected location are not immediately wiped out. It will not be overwritten until you save the new preset, so even though you have initialized it, it can still be recalled, if you should regret, by selecting another preset, and then select this one again, or by using the reload function.

From More... page, touch INIT to enter this page:

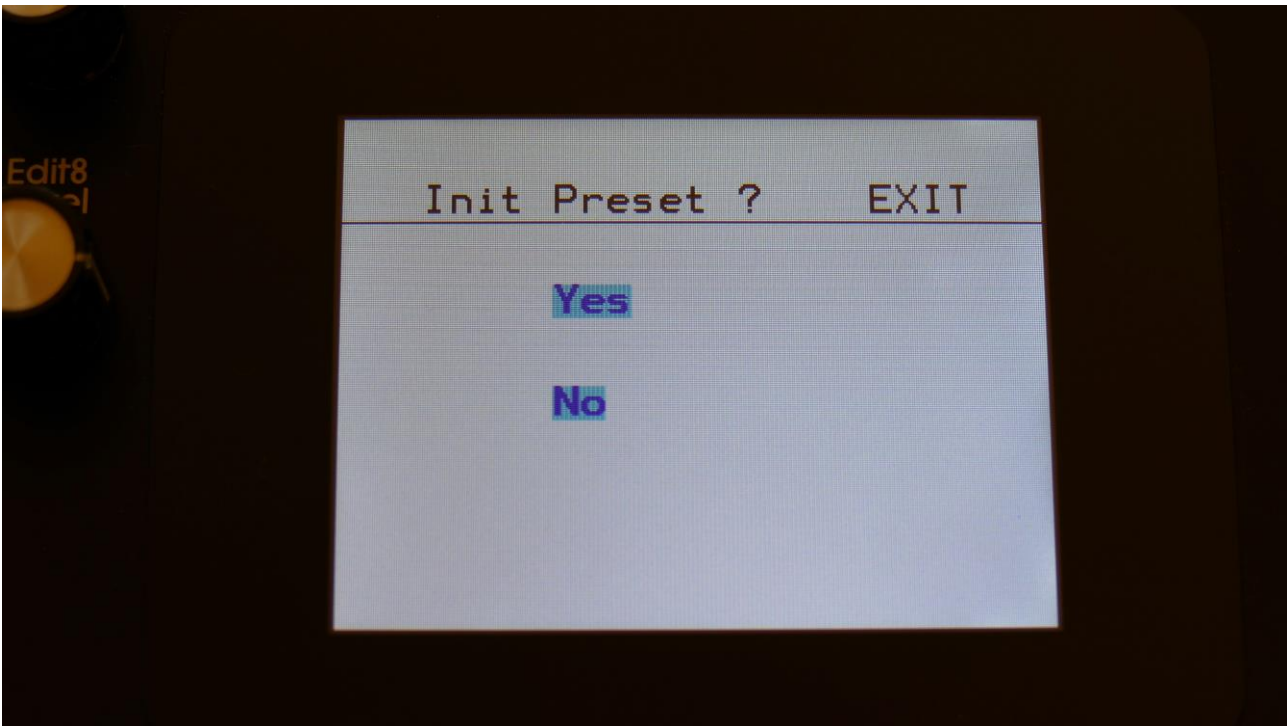

LD3 will now ask you to confirm.

Press "Yes" to initialize the currently selected preset and return to the previous page, or press "No" just to exit, without initializing.

Parameter Snap Mode

A synth part parameters “Snap” mode are available. When this is set to “On”, any synth parameter value will not be changed, when turning a knob, until it passes the original value, that the parameter was set to. This will avoid “jumps” in the sound.

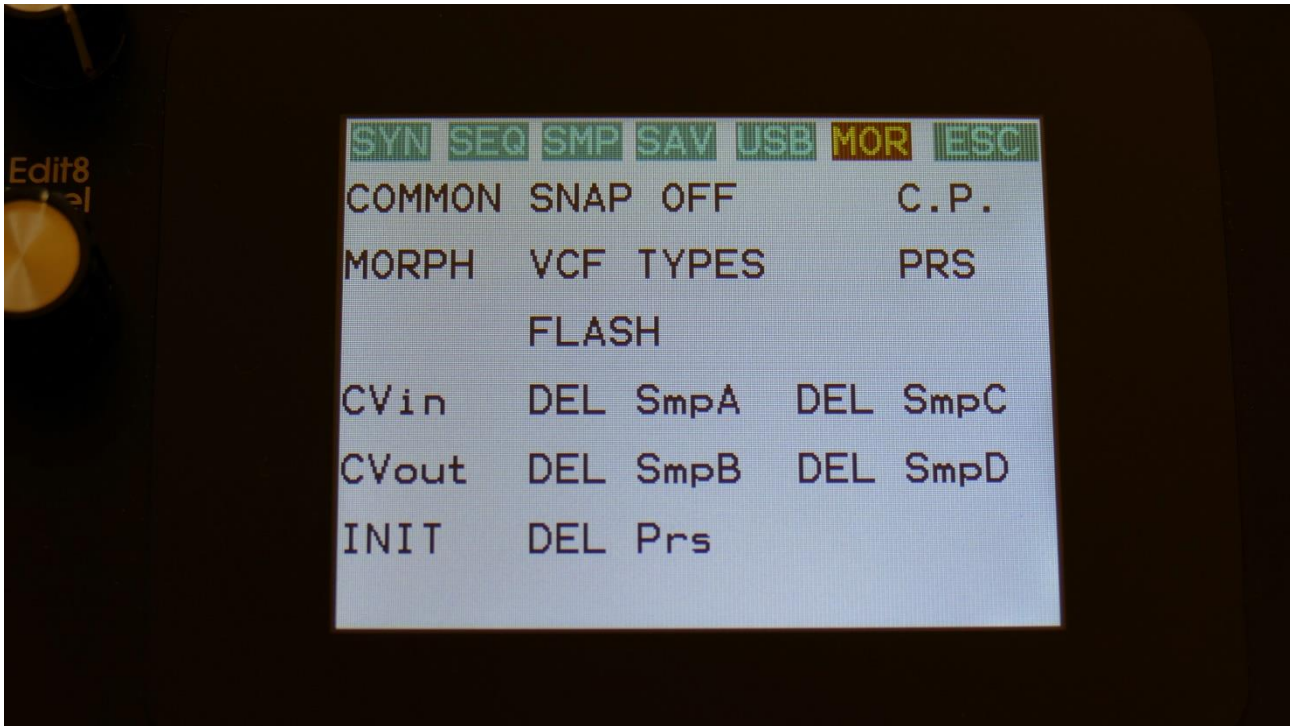

On the MOR page, touch the “SNAP OFF” text.

Parameter snap mode will now be turned on:

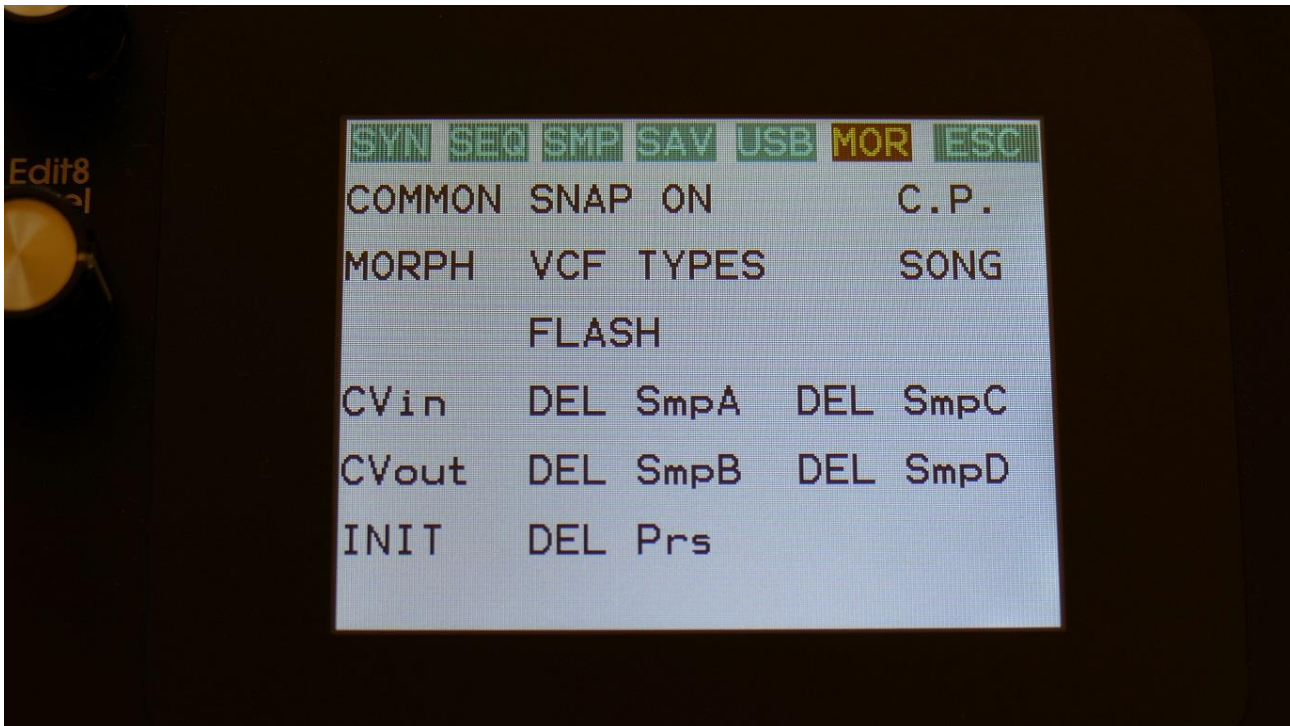

To turn it off, touch it again.

FilterBoards Setup

To get the most out of the analog filters installed in your LD3, you should go to this page to set which filter types are installed, every time you change a filter. When you receive your LD3 from Gotharman's this will be set up correctly, so you should only need to go here, when you swap the filter boards.

From More... page, touch VCF TYPES to enter this page:

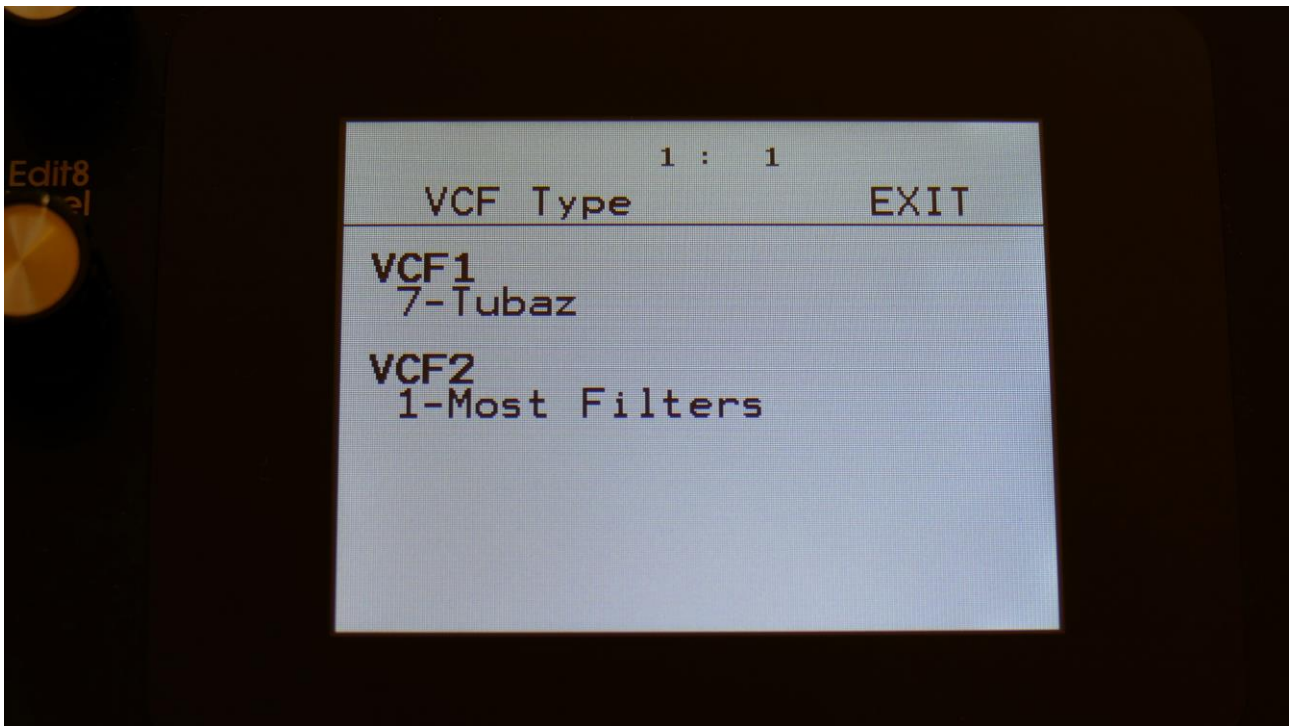

Turn Edit Knob 1 to select FilterBoard1 (**VCF1**), and Edit Knob 5 to select FilterBoard 2 (**VCF2**).

Explanation of the possible types (Further explanation of each filter type in the Synth Parts section):

- 1:** Most filters. VCF1, 2, 3, 4 and 9.
- 2:** VCF5 -MiniProphet filter.
- 3:** VCF6 -SP filter.
- 4:** VCF7 –Tubaz tube filter.
- 5:** VCF8 – Dual band SSI filter.
- X2:** SPAZEboard 2.

The Spazeboard2 can only be selected for **VCF1**. When **VCF1** is set to Spazeboard2, the setting of **VCF2** is ignored, but 2 other parameters are available, **Brd2** and **Brd3**, for selecting the Filterboards attached to your Spazeboard2:

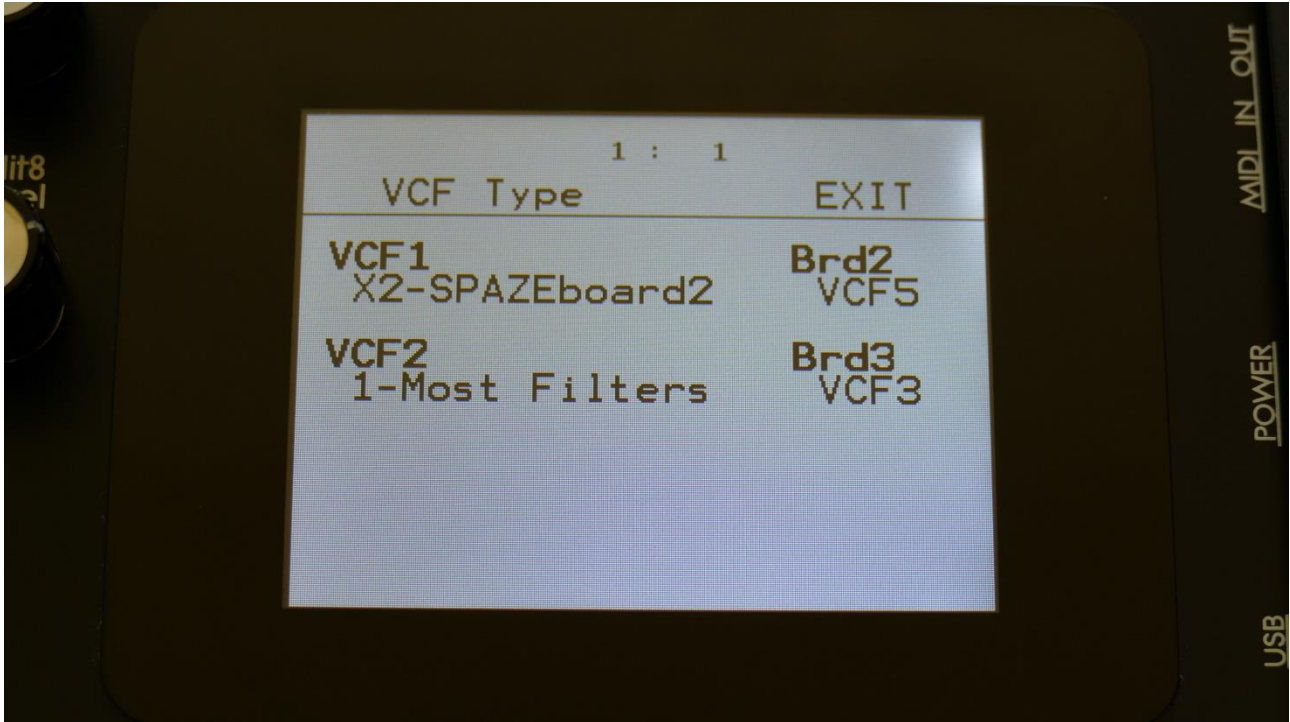

Unlike the VCF1 and VCF2 parameters, the Spazeboard2 filterboards has an individual setup for each of the (currently) 9 available filterboards. So if you have filterboard 5 and 3 installed, you must select VCF5 and VCF3, as shown on the picture. Please read more about these settings in the Spazeboard2 section of this manual.

FLASH Memory Check

From More... page, touch FLASH to enter this page:

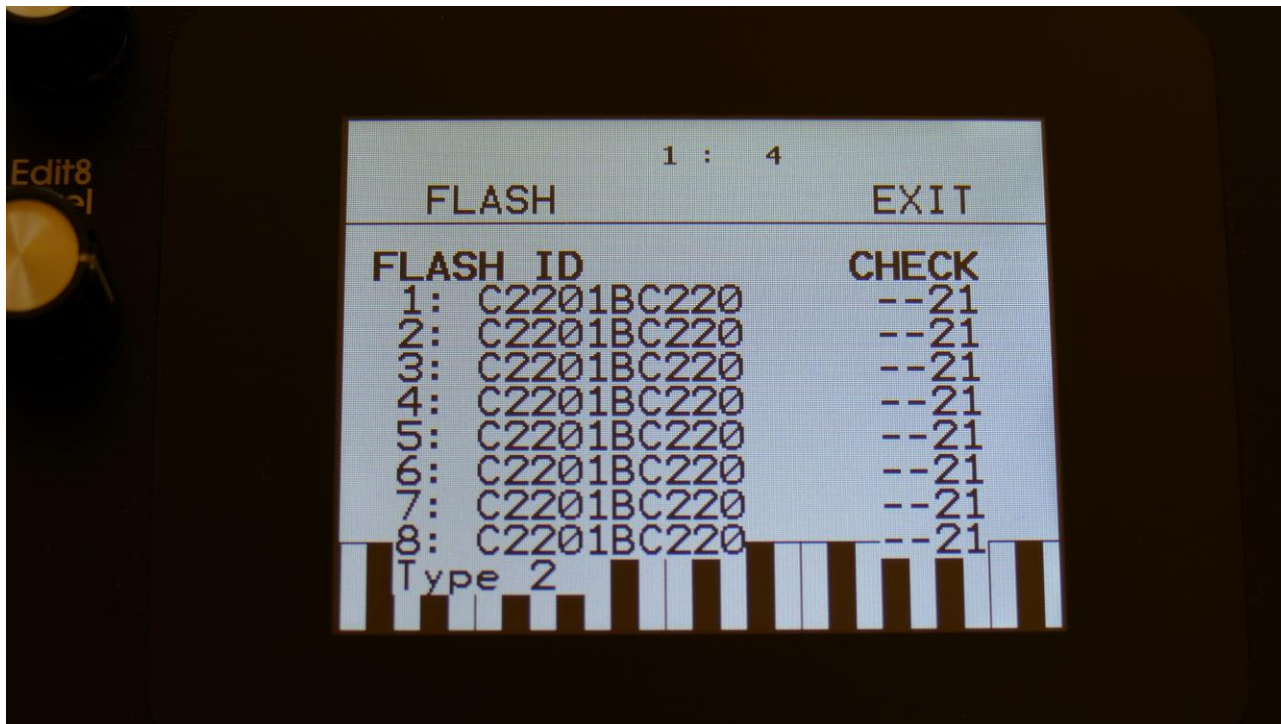

On the Xpanded model, this page should look exactly like on the picture. On the un-Xpanded model the numbers will slightly differ, and it will say Type 3 in the bottom.

If you should ever experience any issues with missing samples or presets, please take a picture of this screen, and email it to Gotharman's.

Delete a Sample Bank

It is possible to completely erase the sample banks. Please think about it, before you do that, and back up your samplings as described in the USB section later in this manual, since if you don't have a backup, it will not be possible to recover your samplings again.

From More... page, touch DEL SmpA, to erase sample bank A, or touch any of the 3 other choices, to erase the respective sample bank.

LD3 will now ask:

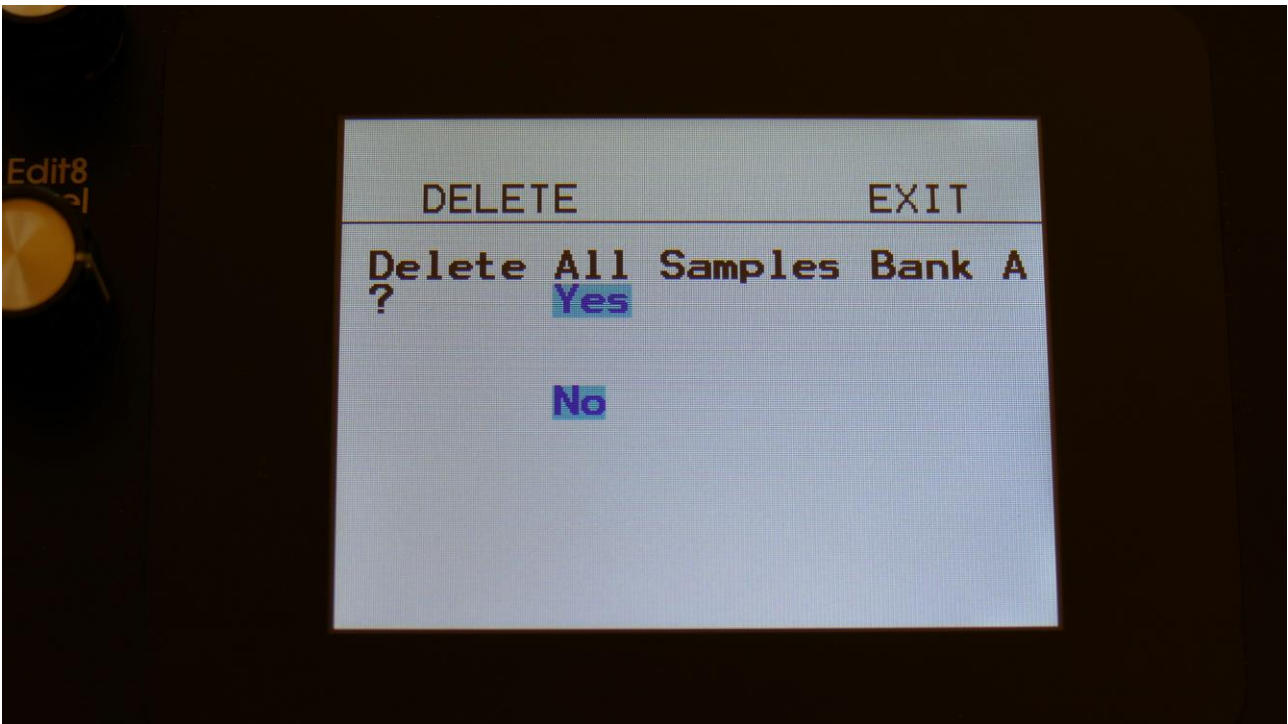

If you are really sure, that you absolutely have to do this, touch "Yes" to start the erase. The sample bank will now be completely wiped out. While it is being erased, LD3's 16 step buttons will run a sequence. When the step buttons shuts off, the erase has been done, and LD3 will return to the More... screen.

If you don't want to do this anyway, touch "No" to exit.

Delete all Presets and Songs

It is possible to completely erase all presets and songs. To do that, if you are really sure, that you would like to, from More... page, touch DEL Prs.

Before you do this, please back up your presets as described in the USB section later in this manual, since if you don't have a backup, it will not be possible to recover your presets again.

LD3 will now ask:

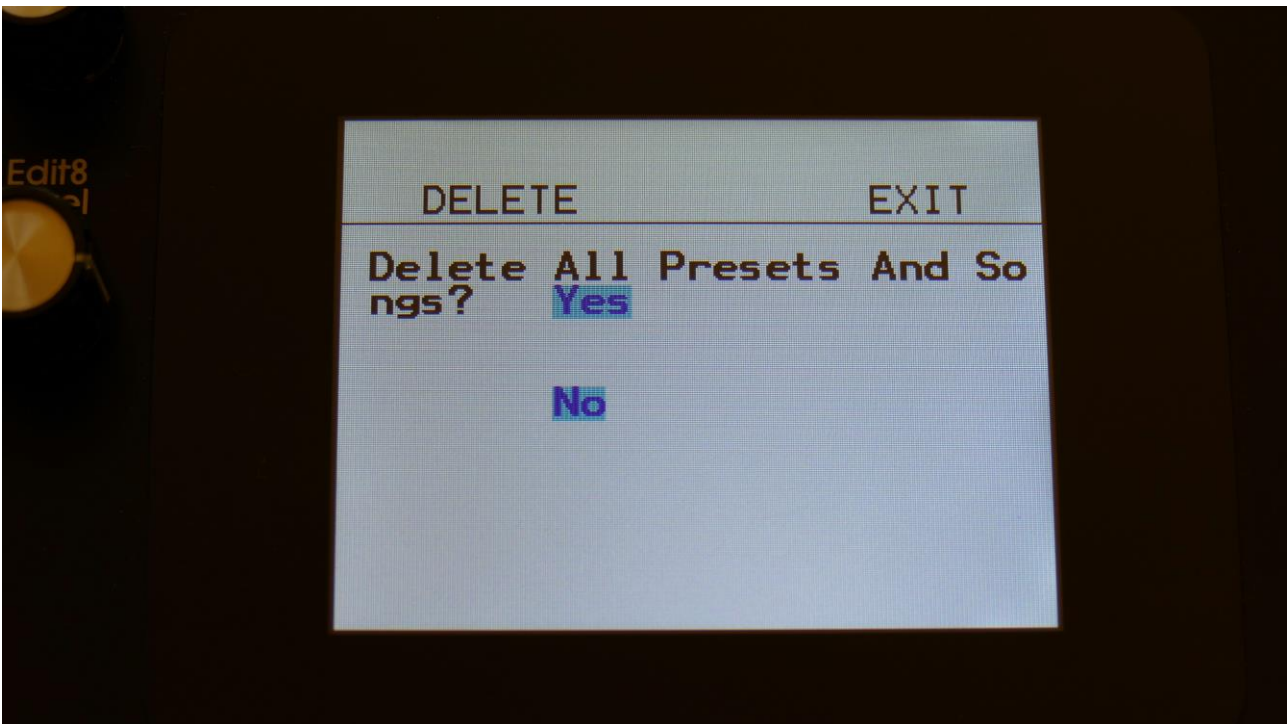

If you are really sure, that you absolutely have to do this, touch "Yes" to start the erase. All presets and songs will now be completely wiped out. While these are being erased, LD3's 16 step buttons will run a sequence. When the step buttons shuts off, the erase has been done, and LD3 will return to the More... screen.

If you don't want to do this anyway, touch "No" to exit.

C.P.

From More... page, touch C.P. to enter this page:



By turning Edit Knob 1 to 4, you can here make the 2 rectangles produce different colours. This does however not have any practical function at all.

Preset/Song Mode

Touch this to toggle between preset mode and song mode. Song mode is described later in this manual.

Display Update Rate

The display has been set to the maximum possible update rate. I have been testing this as much as possible, and did not discover any display freezes.

If you should discover any display freezes, go to the MOR page:

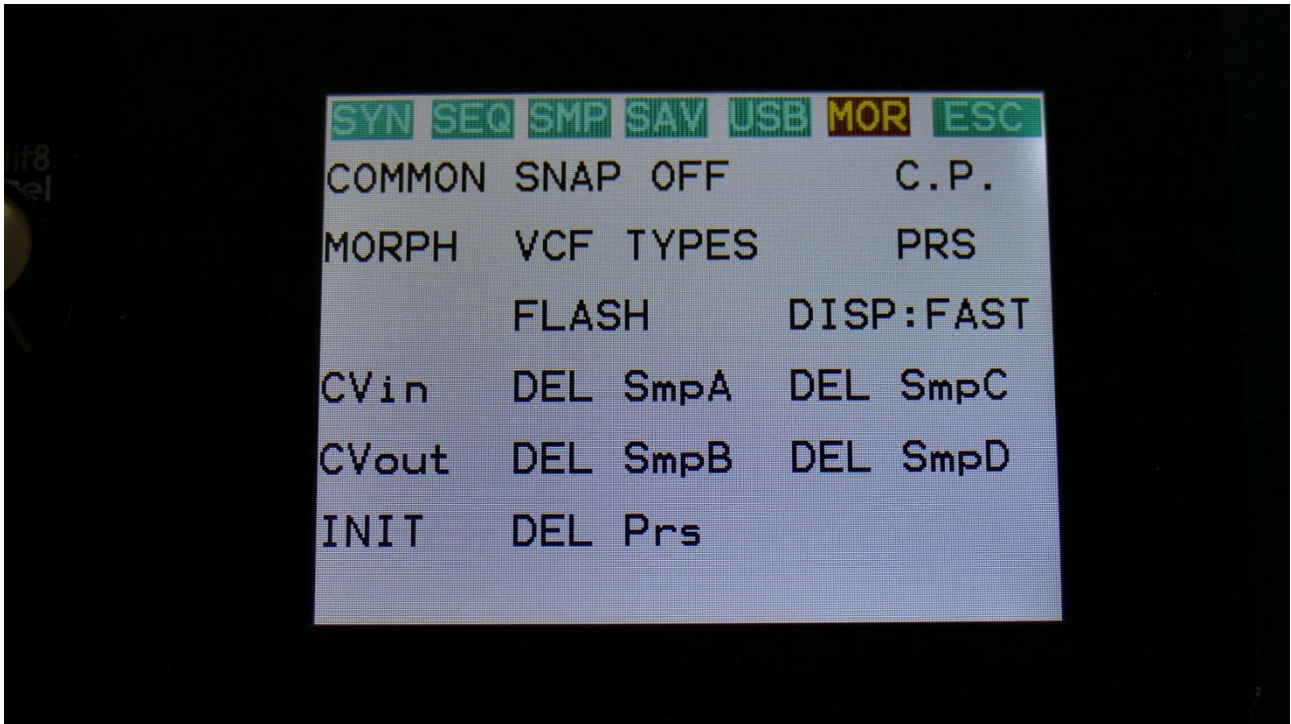

Touch the text: "DISP:FAST". It will now change to "DISP:SLOW" and go back to the slower display mode, as before.

Please report any display freezes to: info@gotharman.dk .

Save Preset

When you have created a new preset, it should be saved for later recall. If you do not save your presets, they will be lost forever, as soon as you select another preset, or turn off your LD3.

A preset that is saved on LD3 contains all the data previously described in this manual:

- All sequencer data
- All synthesizer parts settings
- All effects settings
- All audio bus settings
- All CV in/out settings

From the Preset Select screen, touch the EDIT field, to enter the Main Synth page:

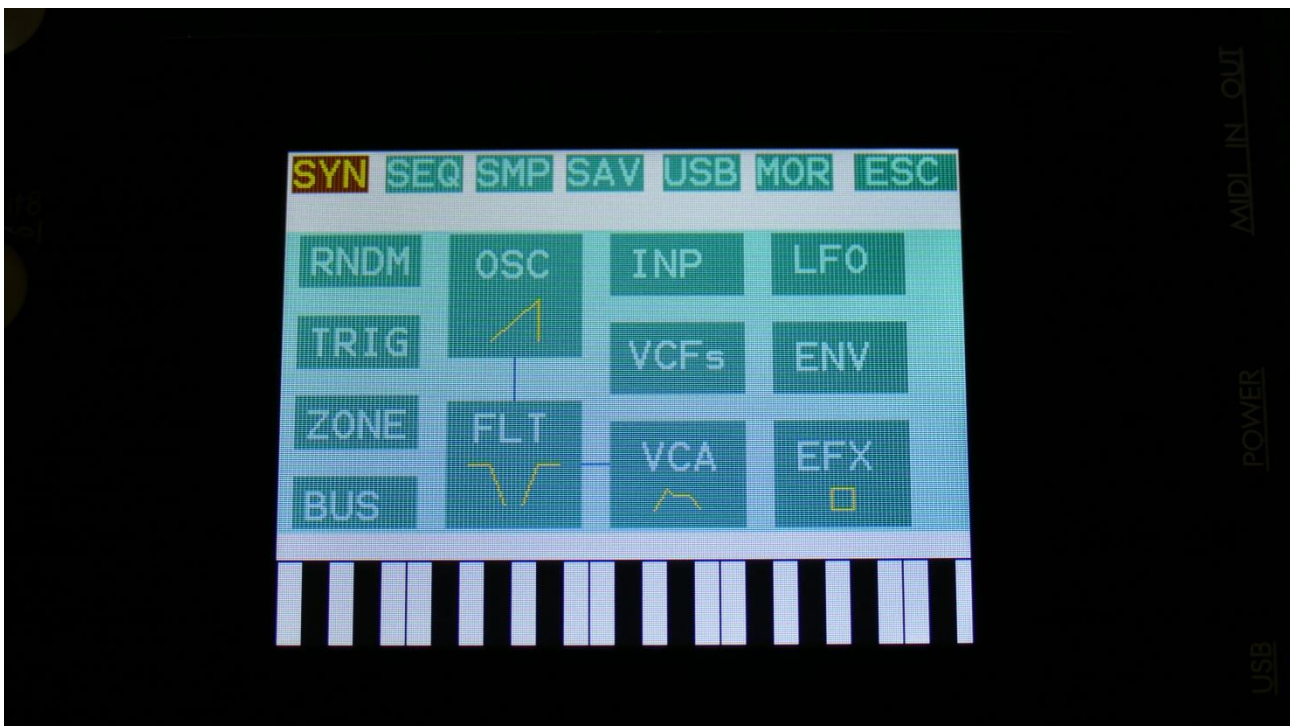

On the navigation bar at the top of this page, touch SAV.

OR: Hit the Func/mute button, so it lights up, and hit step button 15, marked "Save".

You should now enter this page:

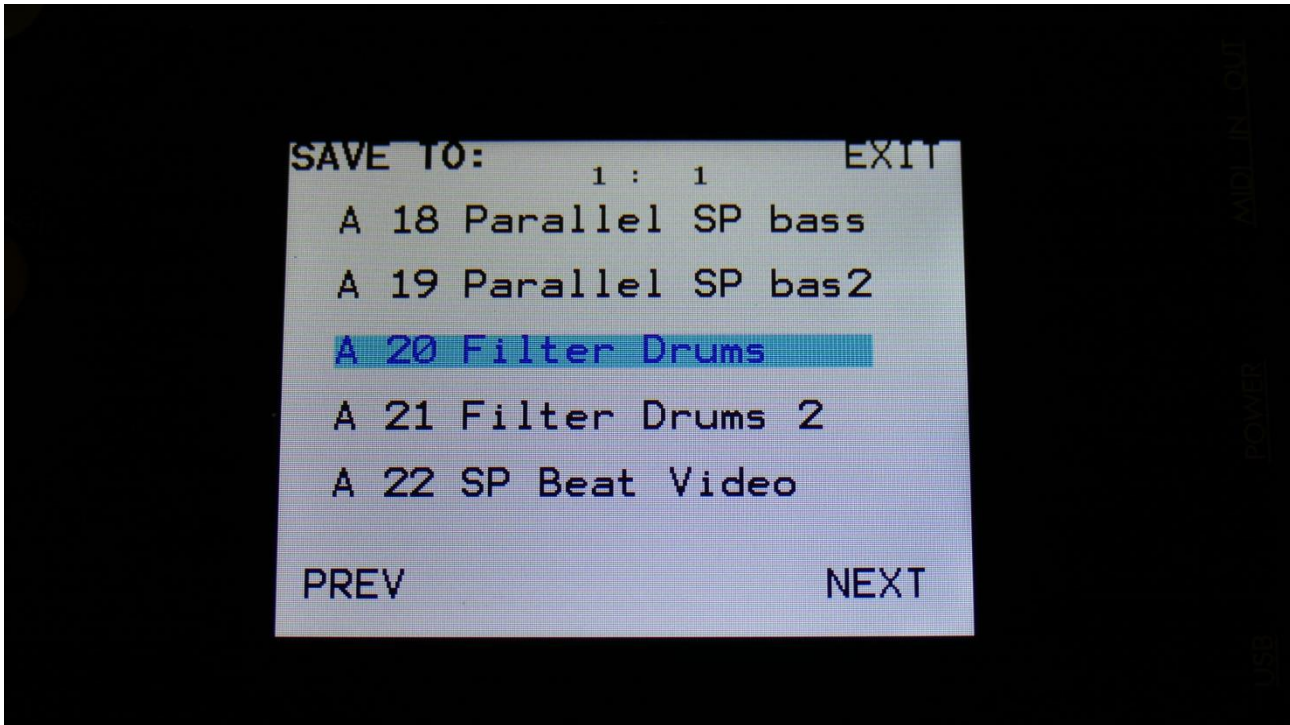

Touch the preset location that you would like to save your new preset to. If it is not shown, touch PREV and NEXT to reach it.

Preset number and name is shown for presets that are already saved. If you save your new preset on such a location, the old preset will be overwritten. On preset locations, where a preset has not yet been saved, the name will be shown as "<empty>".

It is also possible to select the destination preset, using the buttons. This is done in exactly the same way, as when selecting a preset, using buttons. Please see the "Operating LD3" section, in the beginning of this manual.

When you touch the preset location, that you would like to save your preset to, you will enter this page:

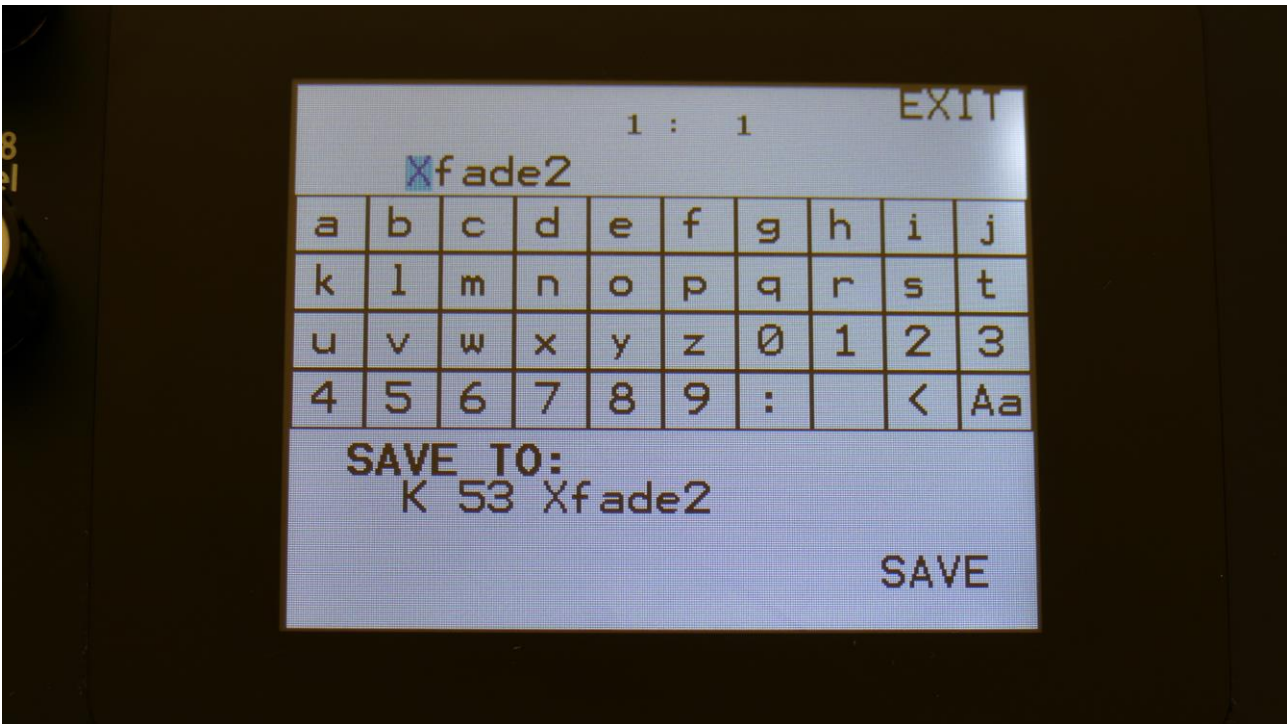

Type in the name for your preset. This can be up to 16 characters long.
 "Aa" will switch between uppercase/lowercase letters, and numbers/signs:

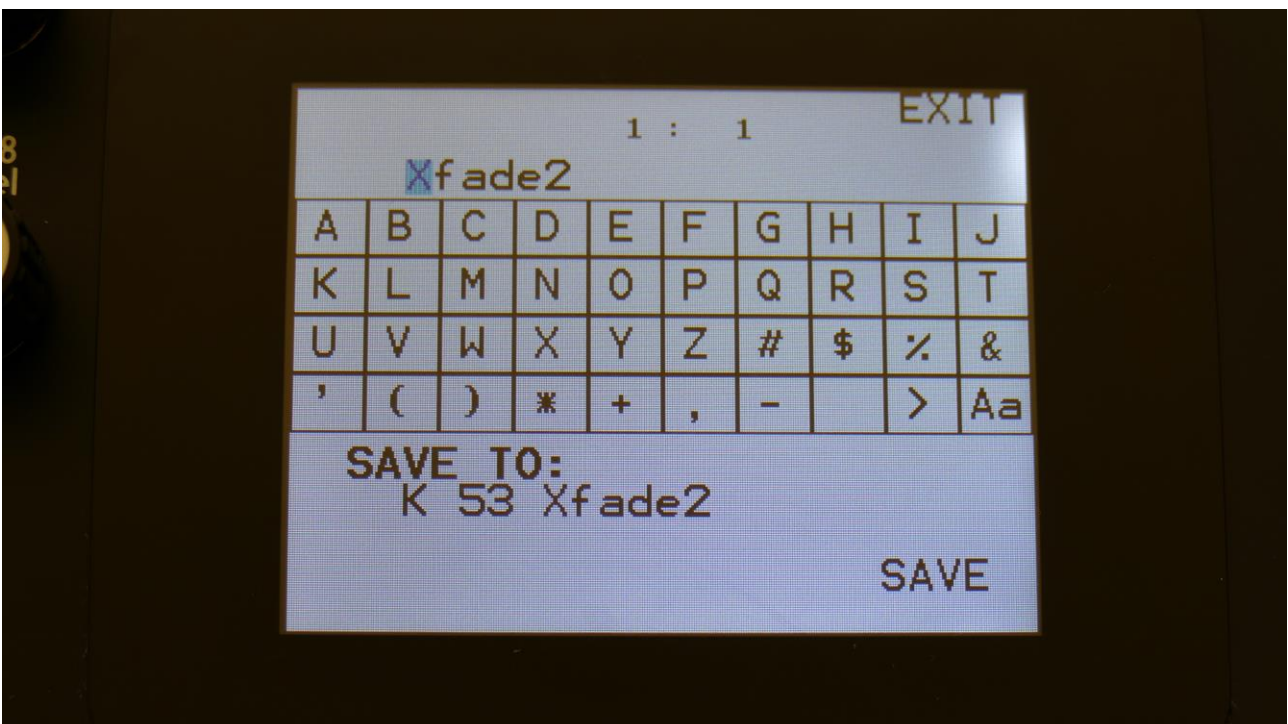

"<" will move the cursor back, for correcting characters, ">" will skip characters.

Touch SAVE when you are done. Your preset will now be saved, and LD3 will exit from the save pages.

Song Mode

It is possible to arrange chained playback of Presets in 1024 Song locations.

Each Song can have up to 128 steps. For each Song step a Preset can be selected, it can be set how many times track one of the preset should play back, until it advances to the next song step, and tracks can be muted/unmuted.

If the last step of the Song is set to "End", playback will stop, when the Song has played back the last preset. If the last step of a Song is set to "Loop", it will jump back to step 1, and continue playback, after the last preset has played.

Songs can be realtime recorded, simply by hitting the "Rec" button on the song main page, then the "Play" button, and then play back the presets that you want in your song.

Songs can also be recorded/edited by putting the Preset numbers and number of times to play back, into a list.

Any presets can be used in any songs.

In song mode you still have access to edit all preset synth parameters, in the currently playing preset, but you can't immediately save any changes you make, since in song mode, you can only save the song.

Accessing Song Mode

If you would like to make a new song from scratch, it can be a good idea to select the preset you would like to have on the first song step, from the preset select page, before you enters song mode. This is not something you have to do, I have just experienced, when testing this, that it makes things a bit easier. When you select a non-recorded empty song, the last selected preset will automatically be placed on song step 1.

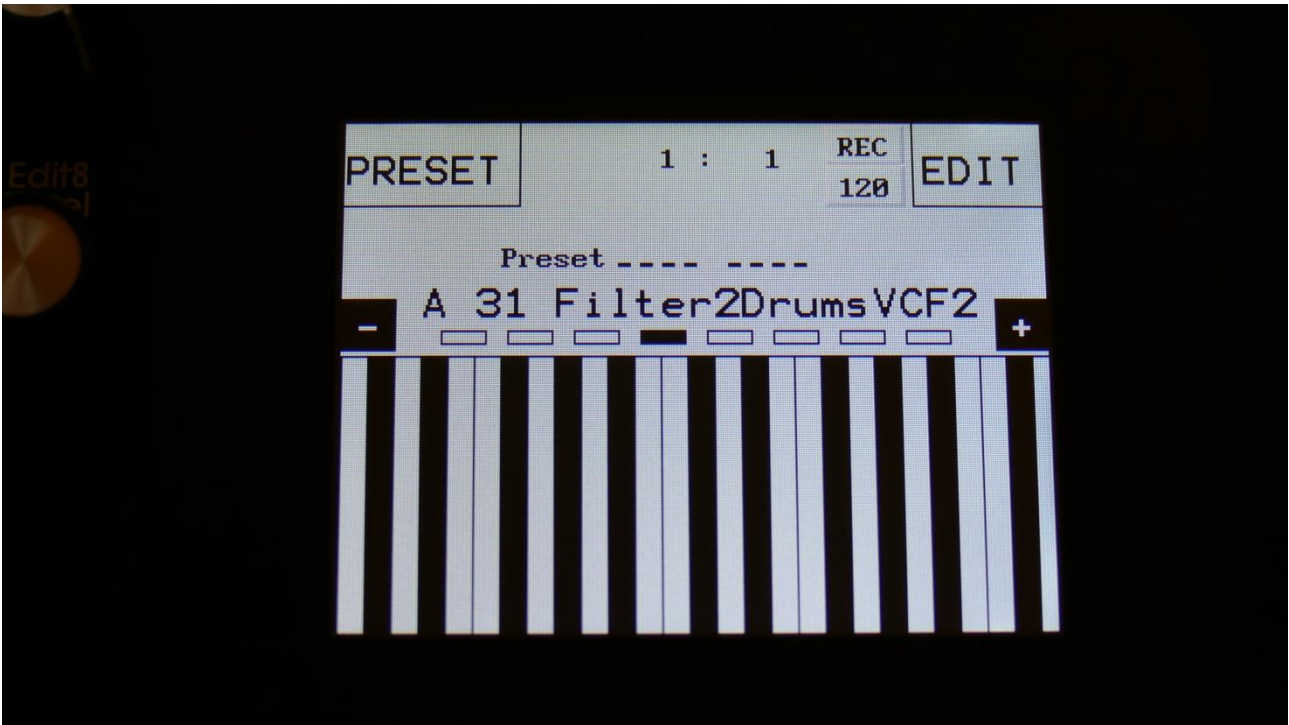

From the Preset Select page, hit the EDIT field.

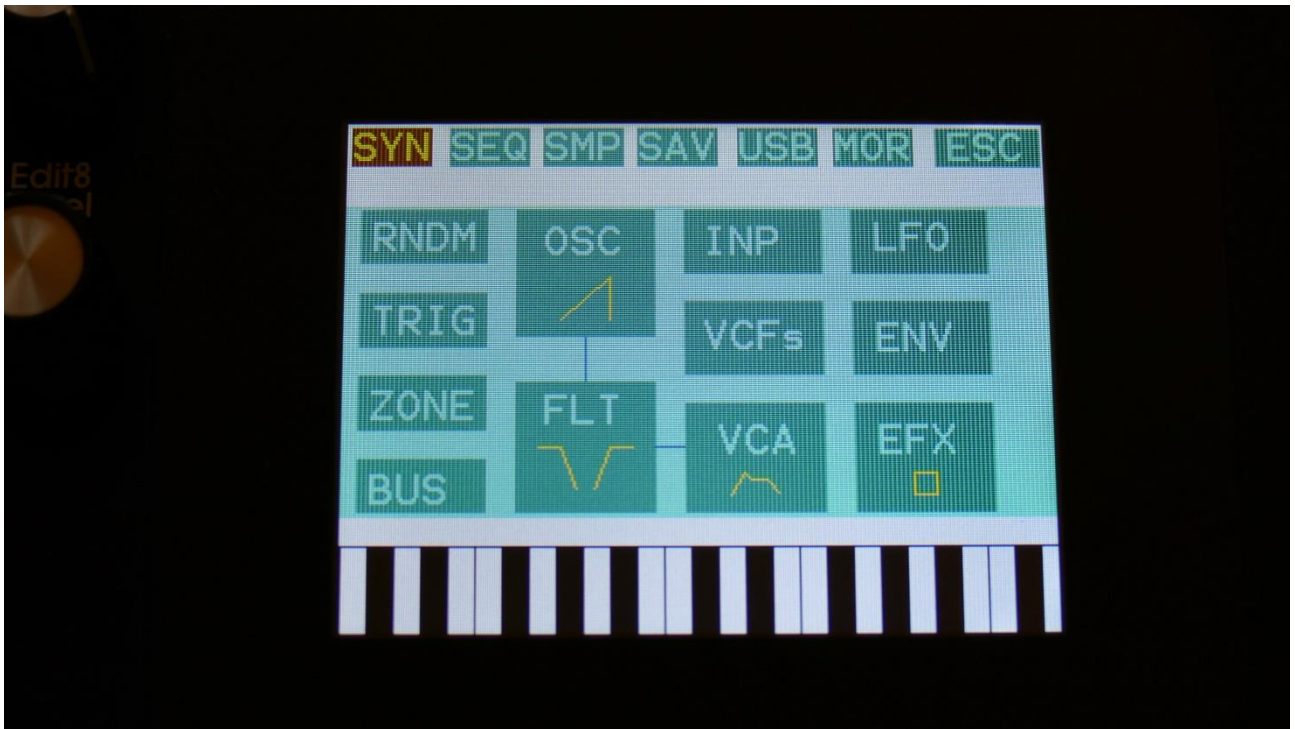

On the navigation bar at the top of the screen, touch MOR...

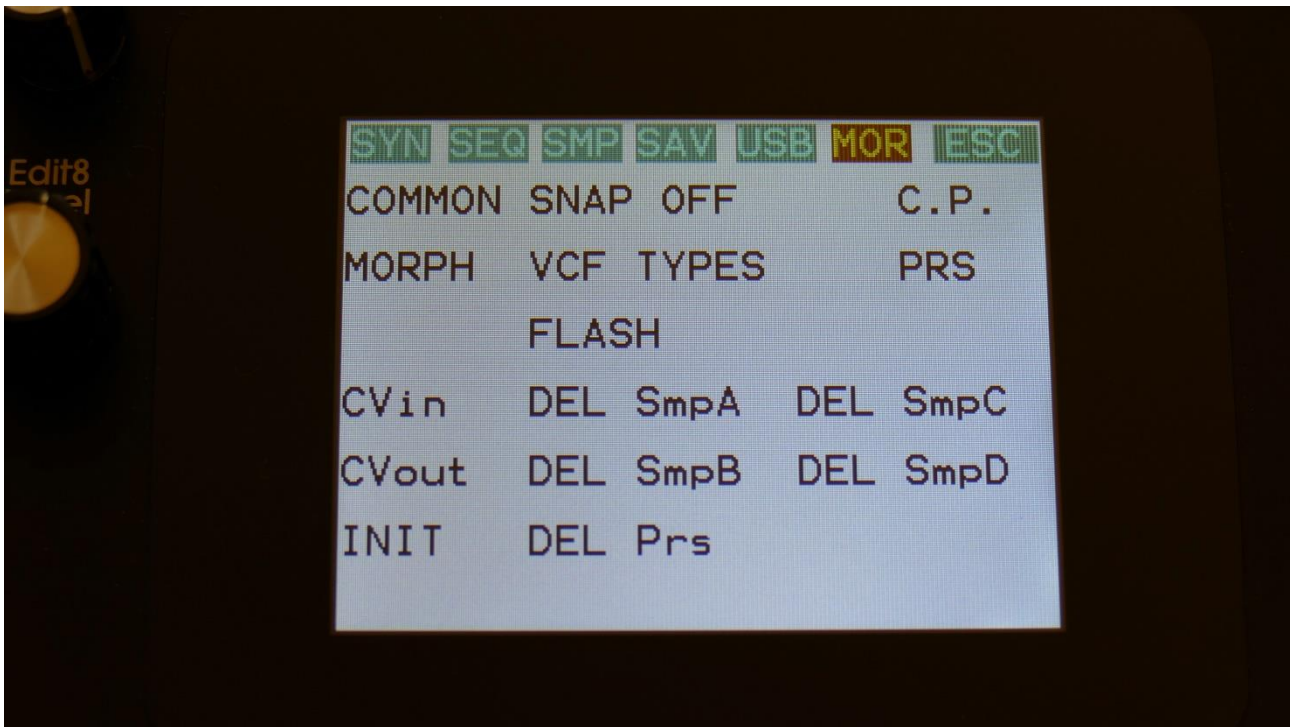

In the far right row, you will find the text PRS. Please touch this, after making sure, that the sequencer is stopped.

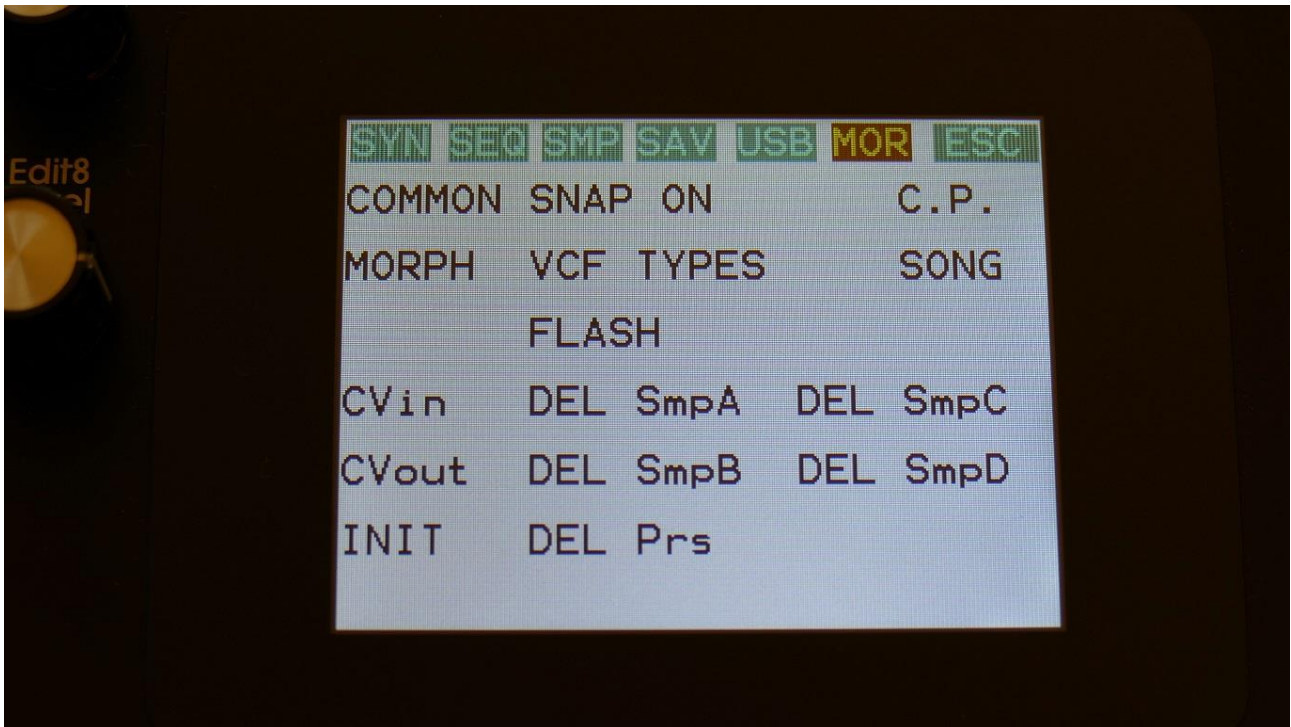

Now PRS turns into SONG, and LD3 are in song mode. If you would like to go back to preset mode, just touch SONG.

The Song Edit Page

To enter the Song Edit page, just touch SEQ on the navigation bar at the top of the More... page:

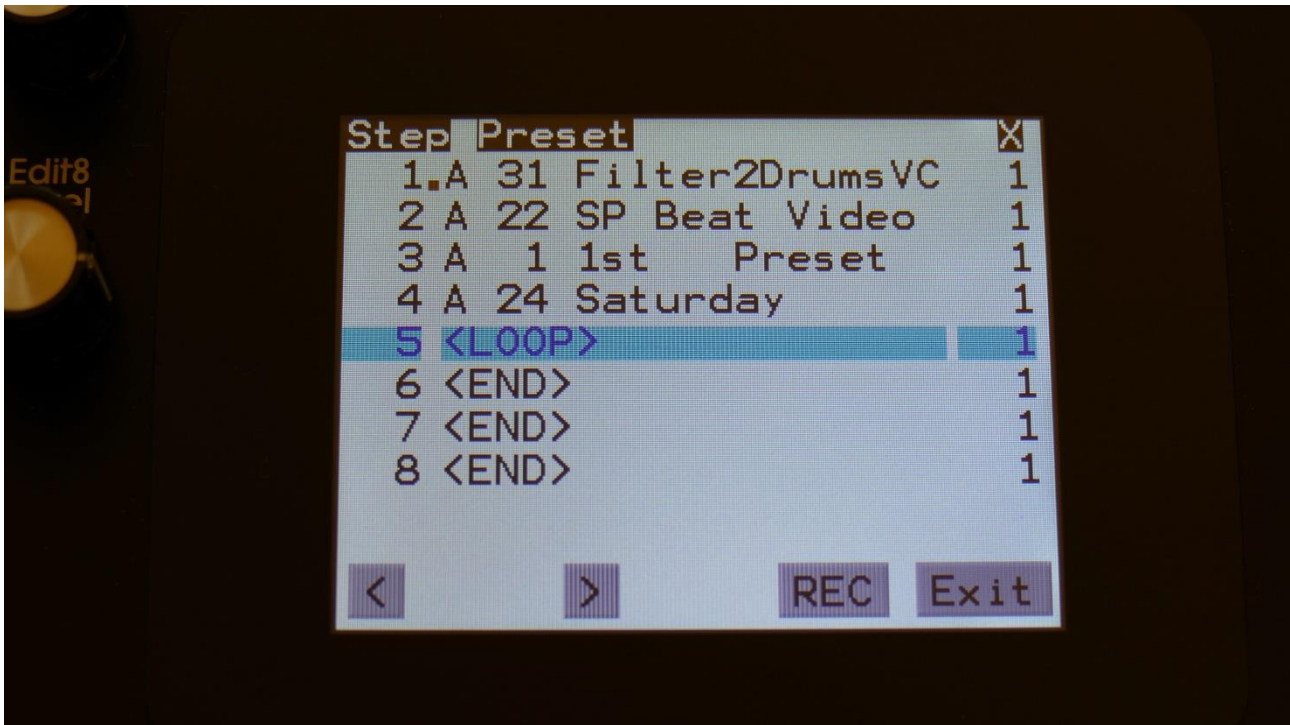

On the Song Edit page, you have an overview of the programmed song steps, and the possibility of editing these.

By touching any of the song steps, you can select this step for editing. The selected step is shown, boxed in blue. The little brown square between the step number and the preset name, is showing what song step is currently being played back.

For each song step, the song step number is shown, the preset number and name, and the number of times track 1 will play back (under the X).

To edit a song step, turn edit knob 1 to select <End>, preset bank A to P, or <Loop>. <End> will make song playback stop, when it reaches that step, <Loop> will make it jump back to song step 1, and start all over again.

Turn edit knob 2 to select the preset number, and edit knob 3 to select the number of times, you want track 1 to play back, for that step.

Push and hold the Func/Mute button, to mute/unmute tracks on the selected song step, via the step buttons. Only tracks that are unmuted in the preset itself, can be muted by the song sequencer.

8 song steps are shown at a time. Touch the arrows to select the previous or next 8 song steps. The total number of song steps is 128.

Touch EXIT to exit from the Song Edit page, and touch REC to start song realtime recording. This will be explained very soon.

The Song Select Page

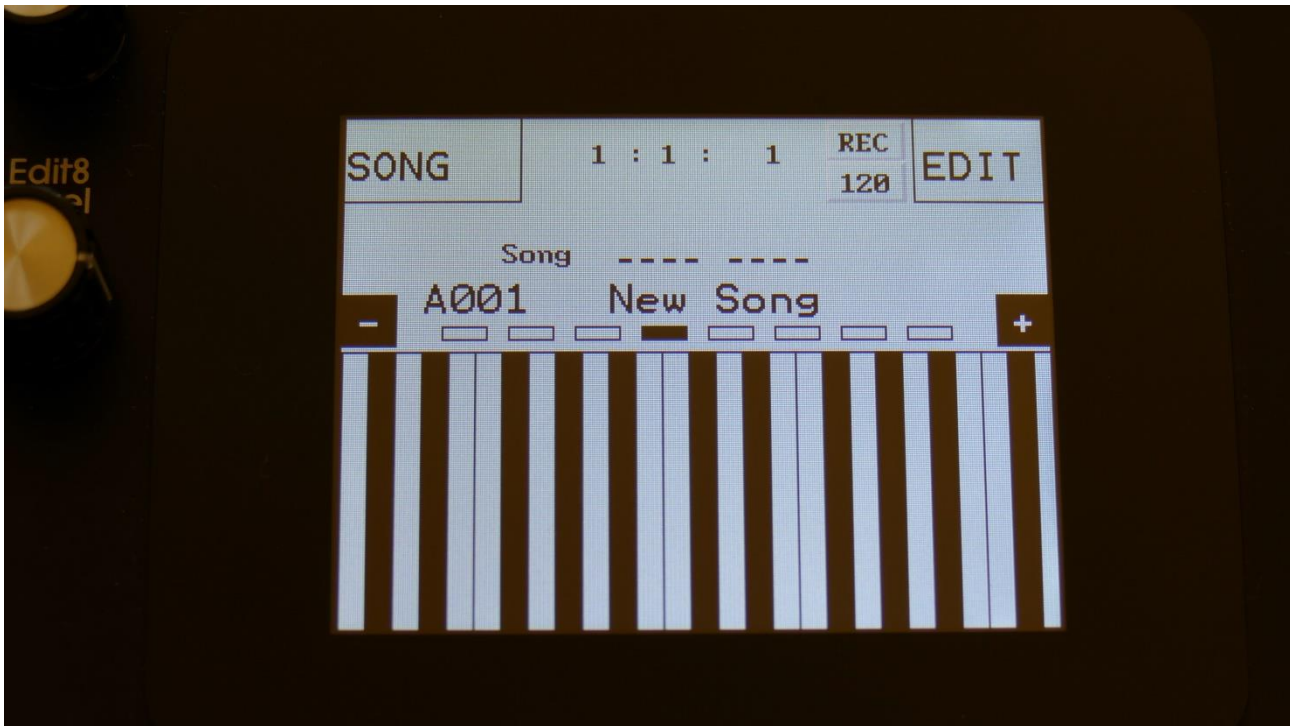

When you, in song mode, exit from the Edit Groups pages, you will exit to the Song Select page, instead of the Preset Select page. This reads out "Song" just above the song number and name, instead of the "Preset", to make sure that you know where you are.

On the top of the Song Select page, you might have noticed, that the sequencer position ruler has gained an extra digit. The first digit of this now shows the song step number, that is currently being played back. The 2 other digits is still showing the bar and the beat of the preset, that is currently playing back.

Other changes to this, compared to the Preset Select page, are that the field in the upper left corner, that was used to select preset with, now has been renamed to SONG, and is used to select song with. It is only possible to select another song, while the sequencer is stopped.

Besides from these changes, everything is the same as in preset mode. You can still edit the synth parameters of the currently playing preset.

Selecting a song:

Make sure that the sequencer is stopped.

Touch the "SONG" field. A list of 5 songs near the currently selected song, will now appear:

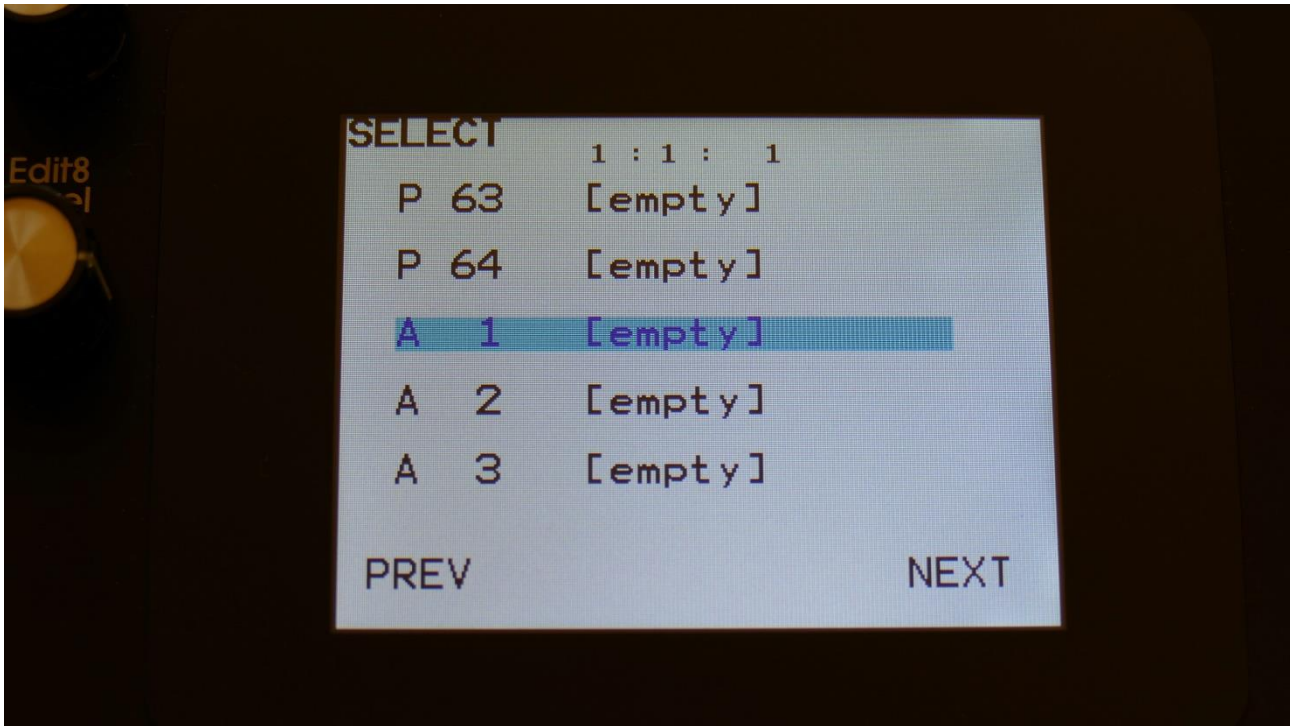

Touch "PREV" or "NEXT" to view the previous or next 5 songs, and finally touch the song name of the song you would like to select. 1024 songs can be selected, from A01 to P64.

LD3 will now jump back to the main Song Select screen, and show the name of the newly selected song.

When LD3 is turned off, it will remember which song was selected, and start up with this, when turned on again. It will also remember if it was in preset or song mode, and start up in the same mode.

Song Realtime Recording

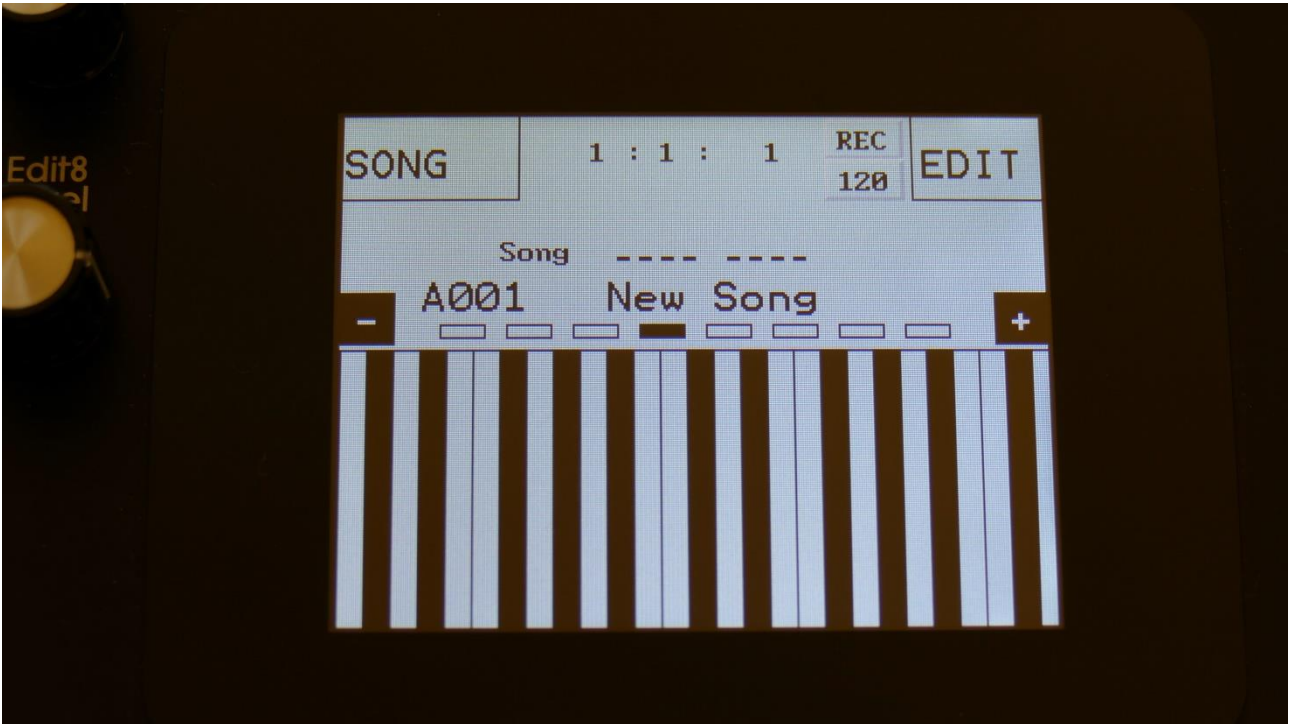

On the Song Select page, select the song you would like to record. 1024 songs are available, from A00 to P64.

Now go to the song edit page.

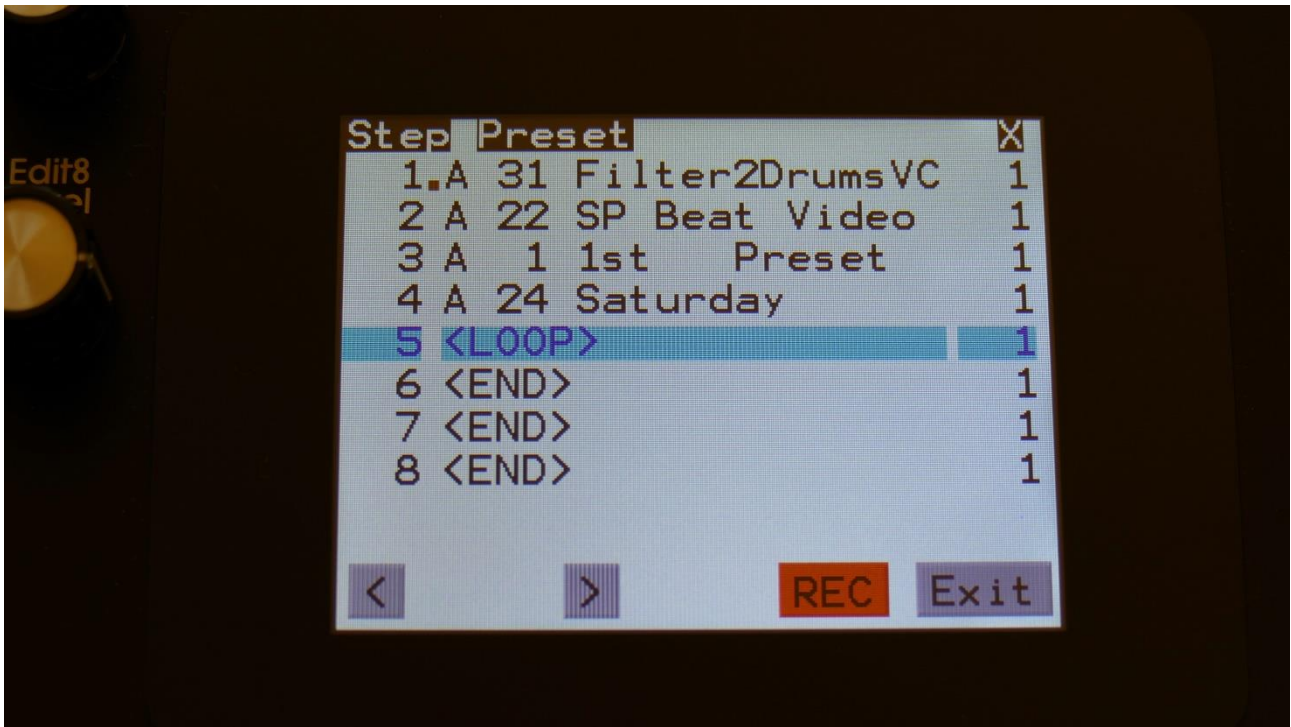

Make sure that the sequencer is stopped, and push the “**REC**” button, so it turns red.

Now exit to the Preset/Song select screen.

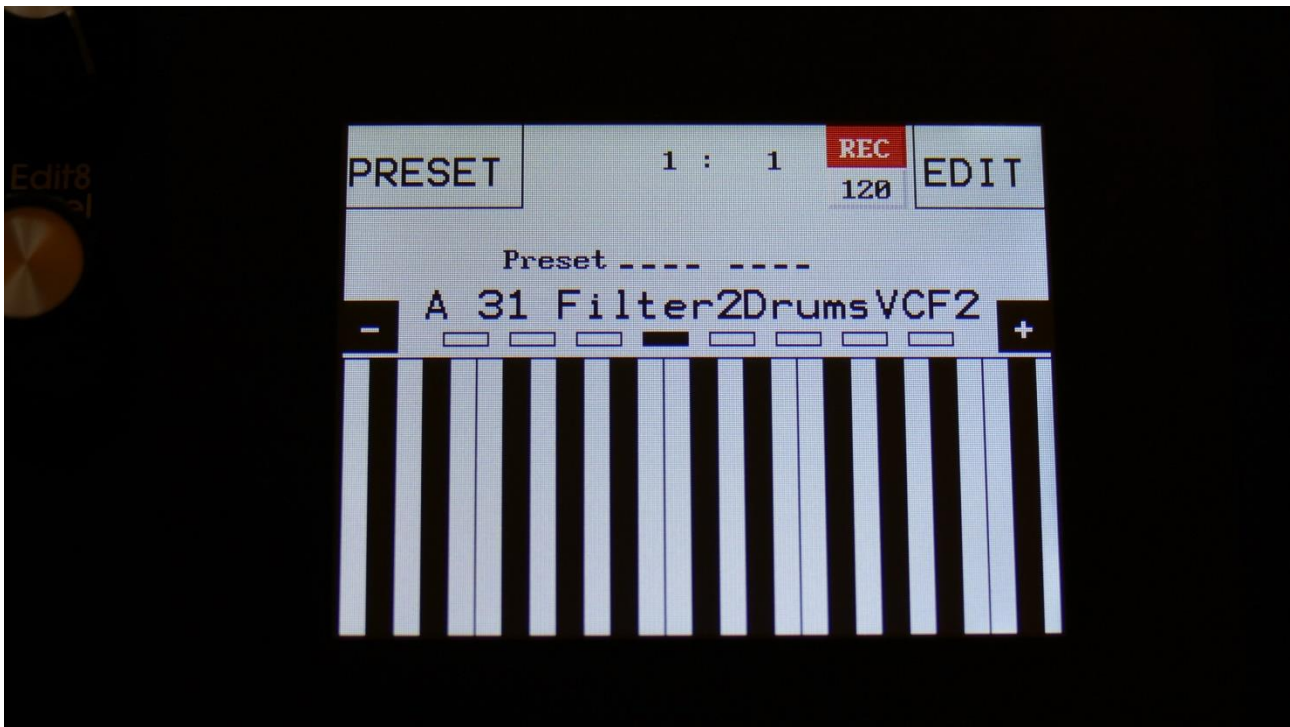

LD3 will now show the Preset select page. The REC indicator on the preset select page, has now turned red, indicating that LD3 is in recording mode. Song realtime recording can also be switched on or off, by touching the REC indicator.

If you selected an empty song, the last preset you selected, before you jumped to song mode, will be shown. If you selected a song that was already recorded, the preset on the selected step of this song will be shown.

Now, if the shown preset are the preset you would like to have on step 1 of your song, you can proceed recording your song, by pressing the Start/Stop button.

If you would like another preset on step 1 of your song, please select this, using the preset select field, and then push the Start/Stop button, to start the recording of the song.

The preset you selected will now start to play back.

From here you can now select other presets, at the time you want these to play back in your song.

Preset changes will only be registered and recorded, when track 1 of the currently playing preset reaches its end and starts over. When the changes has been registered, the song step number in the position ruler will increment by one.

While any preset is playing back, it is possible to mute/unmute the sequence tracks. Push and hold the Func/Mute button, and switch tracks on or off, using the step buttons.

To advance to the next song step, to have other tracks of the same preset muted/unmuted, simply reload the preset, by pushing and holding the Morph Set button, while pressing the Start/Stop button.

When you are done changing presets, and you think that your song is ready, hit the Start/Stop button to stop song recording.

Go back to the song edit page, and touch the REC button, so it turns grey again, to exit from song realtime recording, or simply exit to the preset/song select page, and touch the REC indicator.

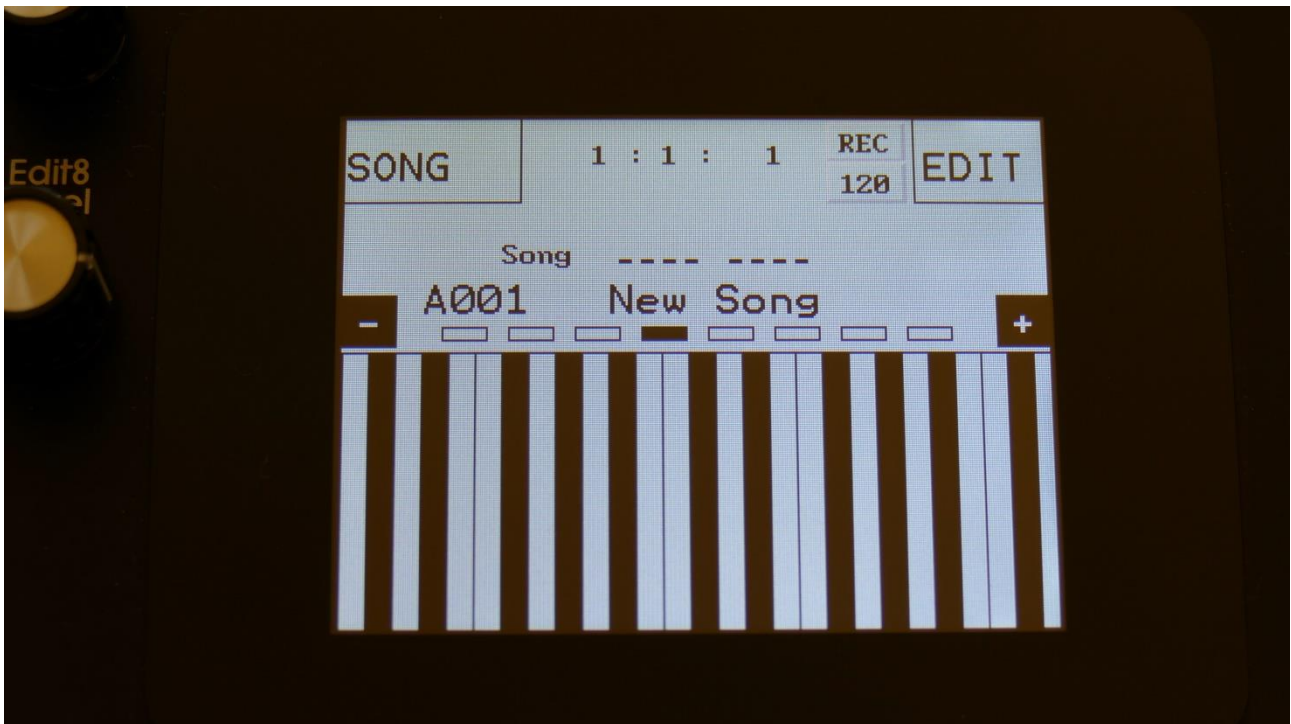

To listen to the song you have just created, just hit the Start/Stop button.

If there are anything you would like to edit, go to the Song Edit page, as described earlier.

If you would like to keep your work, you should save your new song.

Save Song

LD3 songs are not saved within the presets, so they must be saved separately. To do so, when in song mode, from the song select page, touch the EDIT field to enter the Synth parts page:

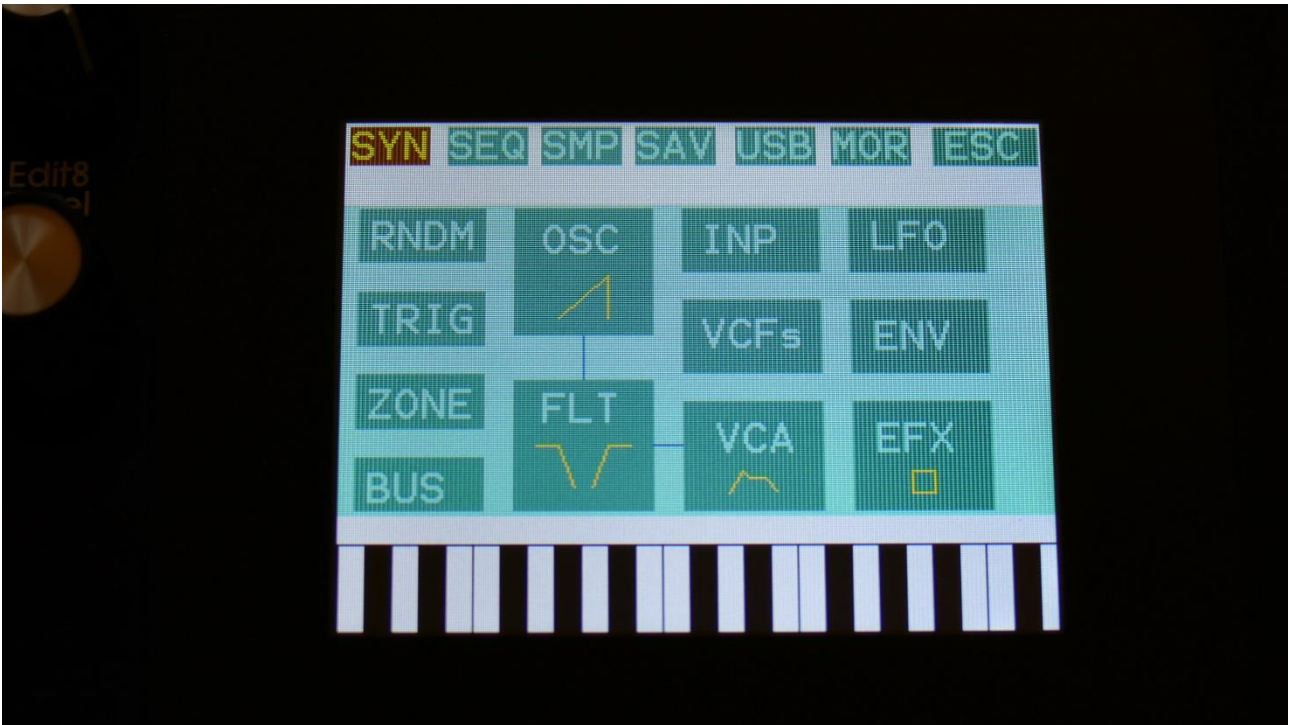

Touch SAV.

You should now enter this page:

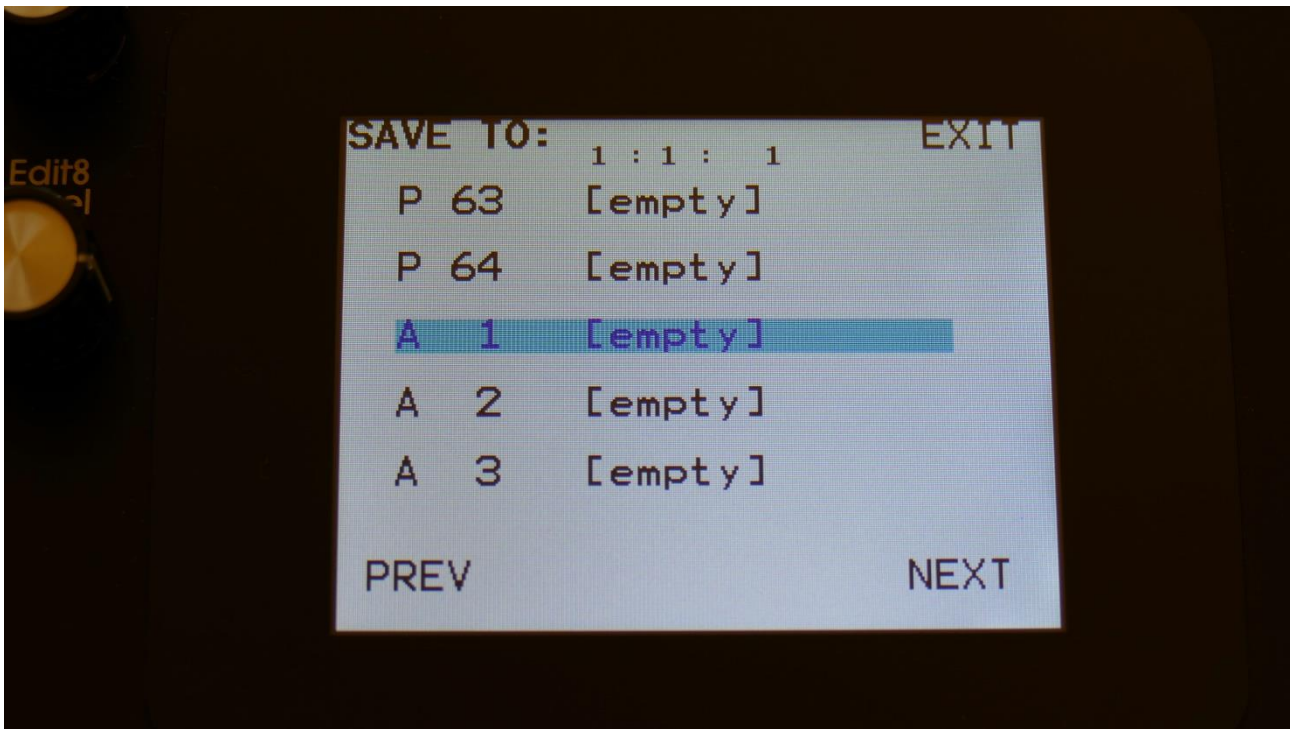

Touch the song location that you would like to save your new song to. If it is not shown, touch PREV and NEXT to reach it.

Song number and name is shown for songs that are already saved. If you save your new song on such a location, the old song will be overwritten. On song locations, where a song has not yet been saved, the name will be shown as "<empty>".

When you touch the song location, that you would like to save your song to, you will enter this page:

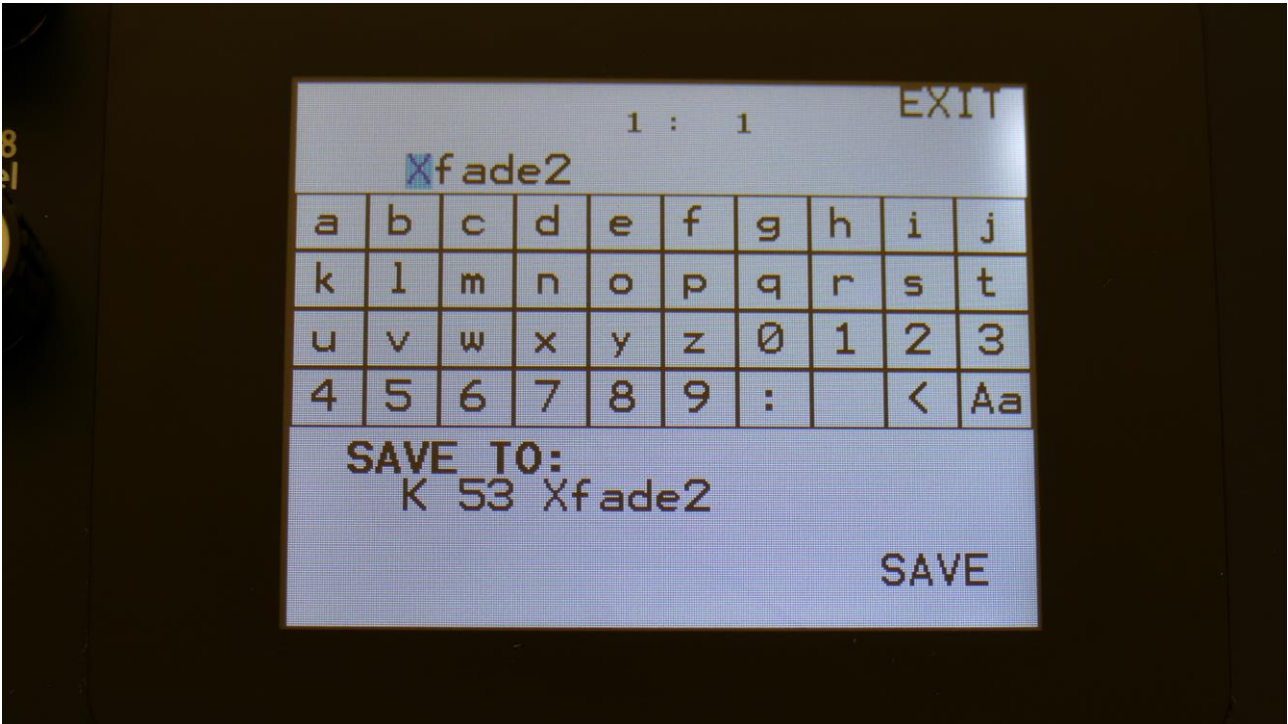

Type in the name for your song. This can be up to 16 characters long.
"Aa" will switch between uppercase/lowercase letters, and numbers/signs:

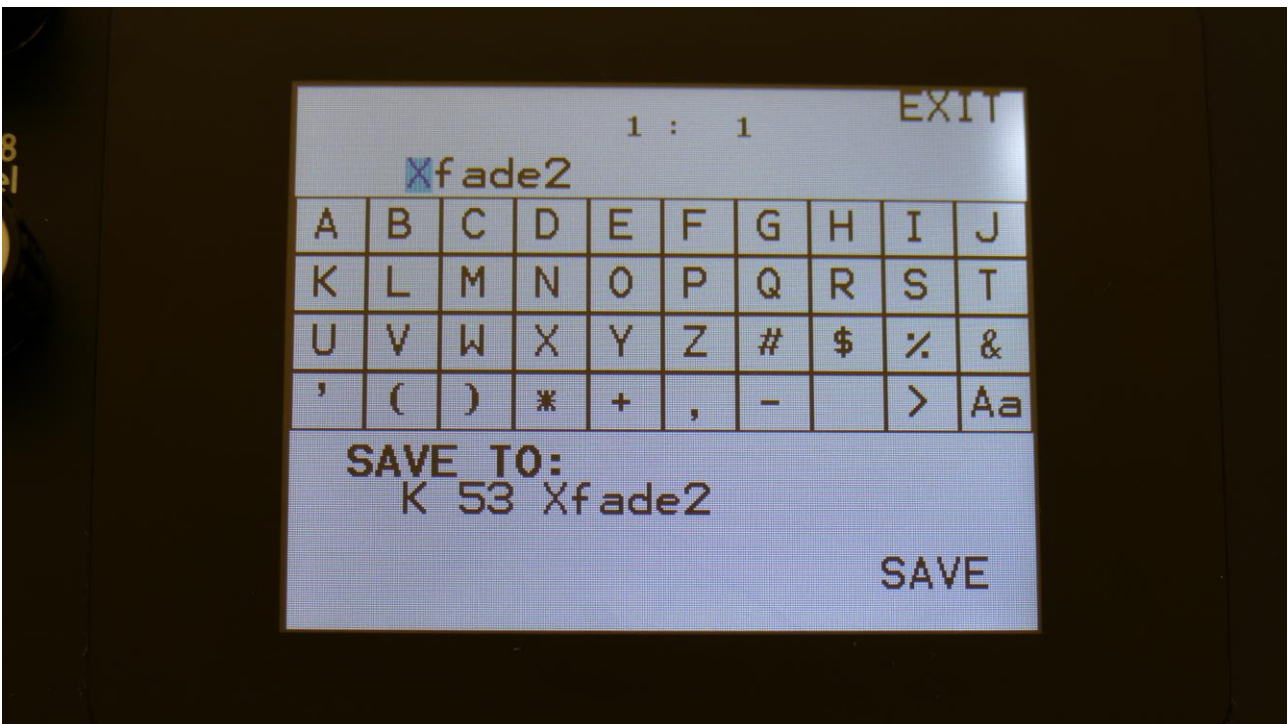

"<" will move the cursor back, for correcting characters, ">" will skip characters.

Touch SAVE when you are done. Your song will now be saved, and LD3 will exit from the save pages.

Initializing a Song

If you would just like to start all over with an empty song, it is possible to initialize it.

To do so, in song mode, access the MOR page:

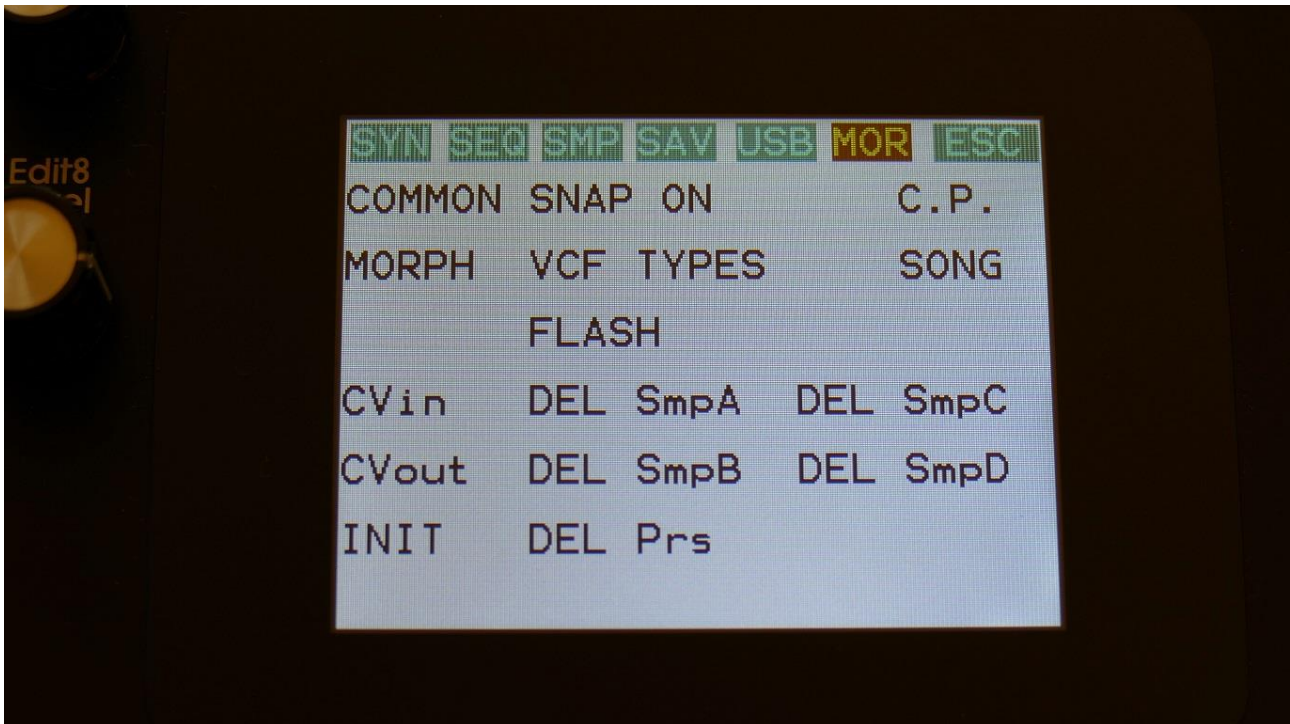

From here, hit INIT.

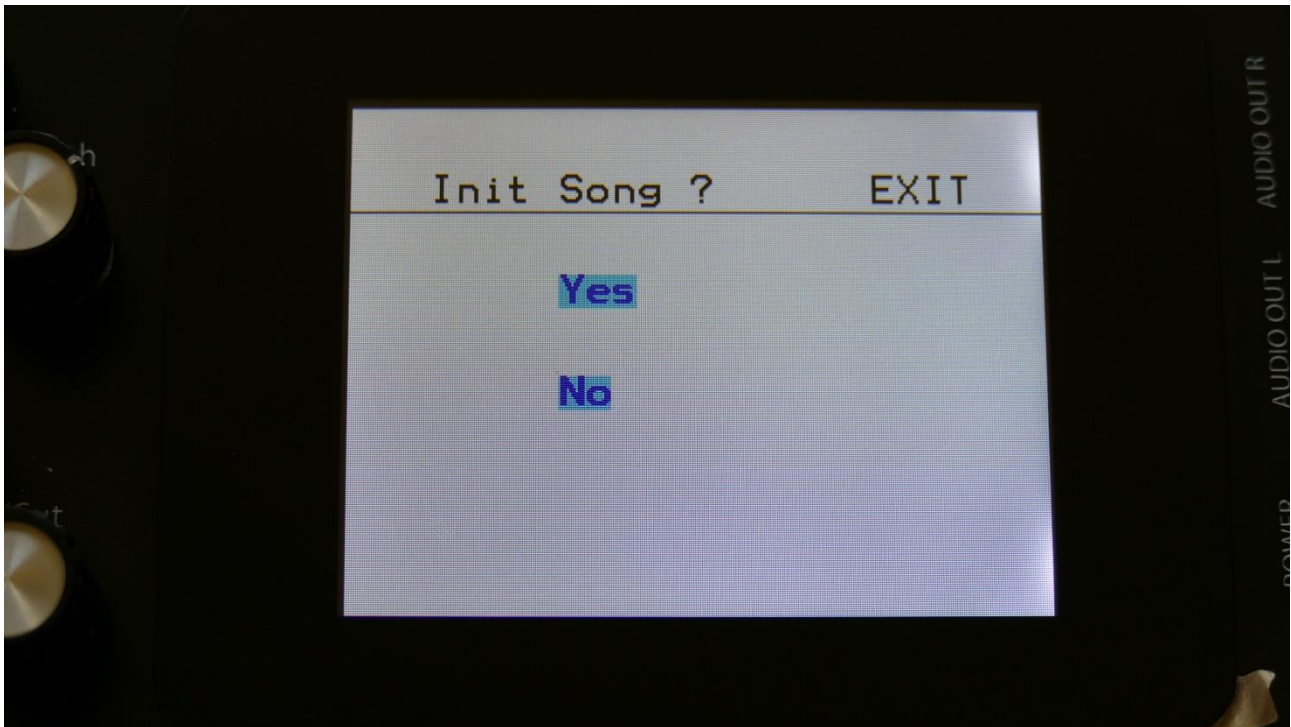

LD3 will now ask you to confirm.

Press "Yes" to initialize the currently selected song and return to the previous page, or press "No" just to exit, without initializing.

Please notice, that when initializing a song, this is only done in LD3's temporary song RAM, NOT on the FLASH memory, so if you did this by mistake, or you regretted doing it, you can always recall the song, by selecting another song, and select this again. Then nothing will be lost. It is not until you save the song, that permanent changes is done.

Copy/Paste

On LD3 it is possible to copy morph layer A, B or the parameter setting at the position of the Morph knob. It is possible to copy one or two layers of the whole preset, or only a section of the preset, like a synth part, the settings of a filter, a sequencer track, and much more.

Whatever is held in the copy buffer can then be pasted to another preset or another section.

If you, for instance, copy a whole preset, or a whole part, and then goes to a specific filter page to just paste the filter settings, only the settings in the copy buffer from the same part number will be pasted. If you would like to copy, for instance, the filter settings from part 3 in one preset, to part 7 in another preset, you will have to go to the specific part filter page, to copy, and then go to the destination filter page to paste.

To copy anything, first go to the page, that will make LD3 copy the desired settings. Possibilities are:

- Preset select** page: LD3 will copy one or two layers of the whole preset.
- Synth part** page: LD3 will copy one or two layers of the selected part. Included in this are the oscillator, the digital filters, VCA and Envelope settings.
- BUS** page: LD3 will copy all the BUS settings.
- Oscillator** page: LD3 will copy one or two layers of the oscillator settings, of the currently selected part.
- Digital Filter** page: LD3 will copy one or two layers of the Digital filter settings, of the currently selected part.
- VCA** page: LD3 will copy one or two layers of the VCA settings, of the currently selected part.
- Envelope page: LD3 will copy one or two layers of the Envelope settings, of the currently selected part.
- VCF (Filterboard)** page: LD3 will copy one or two layers of the VCF settings, of the currently selected VCF.
- LFO** page: LD3 will copy one or two layers of the LFO settings, of the currently selected LFO.
- EFX** page: LD3 will copy one or two layers of the EFX settings, of the currently selected EFX.
- RNDM, TRIG and ZONE** pages: Nothing will be copied.
- Sequencer overview** page: One or two layers of all the sequencer tracks will be copied.
- Sequencer track** page: One or two layers of the currently selected sequencer track will be copied.

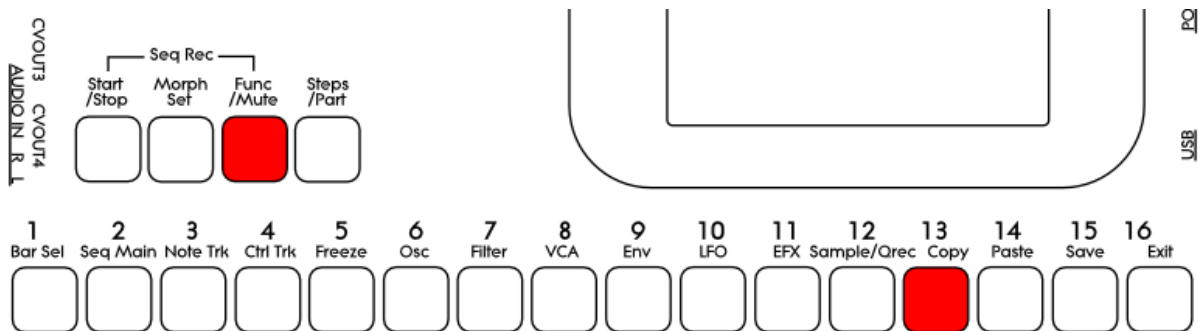

When you are located at the right page, push and release the Func/Mute button, so that it lights up, to enter the function buttons. Now hit step button 13 (Copy).

The display will now show some instructions:

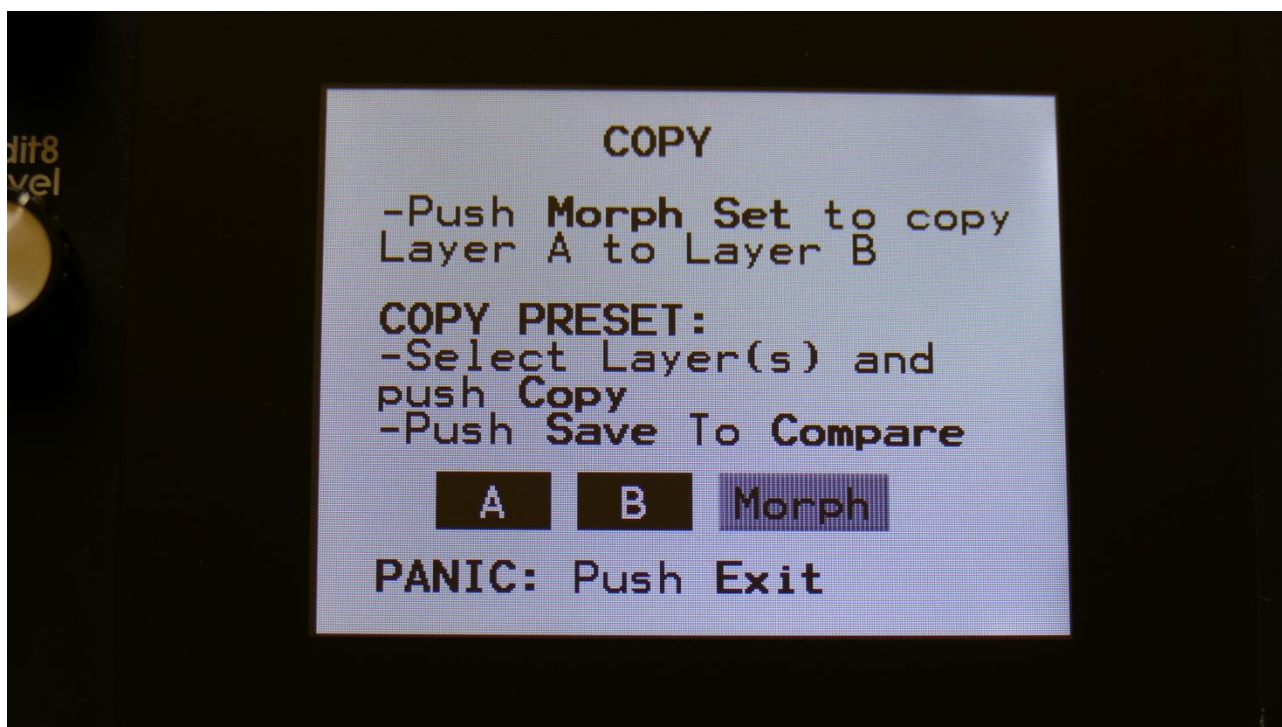

It will tell you how to copy layer A to layer B, and right below this, it will tell you, what it will copy. In the example, the copy function was entered from the preset select page, and LD3 tells you, that it will copy the whole preset.

If you had entered the copy page from a filter page, it would have said "COPY FILTER pt 1" instead.

Now select/deselect the desired layers, by touching the "A", "B" and "Morph" touch buttons. If a layer button is black, it means that this layer will be copied, if it is grey, the layer will not be copied. It is only possible to copy either layer B or the morphed layer. It is not possible to copy both of these at the same time. Layer A can be switched on or off independently of the B/Morph

selection. If 2 layers are copied, LD3 will also paste to 2 layers. If only one layer is copied, LD3 will paste to the layer selected by the Morph Set button.

To copy, hit step button 13 (Copy) again.

Now, when the function buttons are active (the Func/Mute button lights up), every time you enter a page, where the copy buffer holds something, that can be pasted, step button 14 (Paste) will light up.

To paste something, navigate to the desired page, where you would like to paste the settings. Make sure that step button 14 (Paste) lights up. Hit step button 14 (Paste). Your settings has now been pasted.

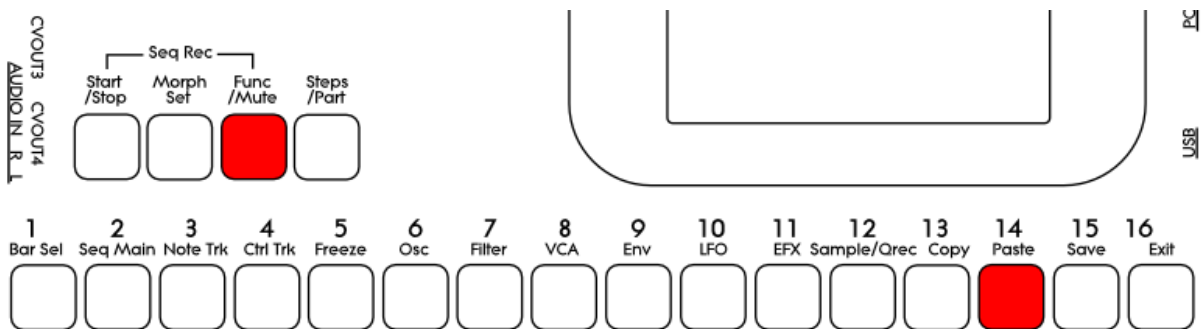

Sample Record and Edit

To get samples into LD3, for using them in the synth section samplers, you can either import .wav files from a USB drive, or record your own samples from LD3's audio inputs or outputs. This section will describe the latter. For how to import .wav files, please see the USB section of this manual.

Samples are recorded and played back in mono or stereo.

LD3 has 4 banks of FLASH memory for storing samples, Bank A, B, C and D. Bank A holds up to 18 minutes of mono samplings (43 minutes in the Xpanded model), maximum 2048 samplings, Bank B, C and D each holds up to 25 minutes of mono samplings (50 minutes in the Xpanded model), maximum 2048 samplings – A total of 8192 samplings/93 minutes or 193 minutes. One sampling can maximum be 50 minutes long. Sample times in stereo are half of the mono sample times.

All samples that are imported or recorded, stays in LD3's FLASH memory, even after a power off. Since they are played back directly from the FLASH memory, there are no loading times. All LD3's samplings are immediately available, right after power on, and can be selected in the synth oscillator section, just like synth waveforms.

Recording a sampling

From the Preset Select screen, touch the EDIT field, to enter the Main Synth page:

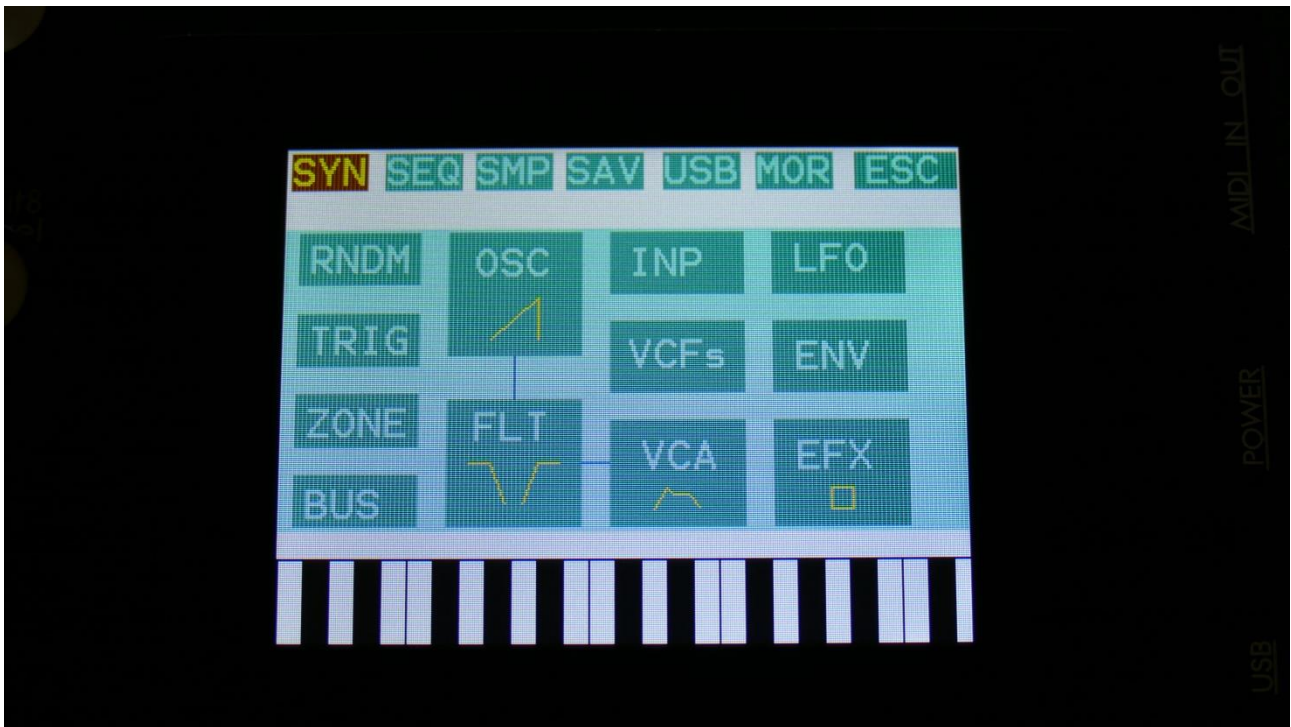

Touch SMP at the top navigation bar.



You will now enter the Sample Edit page.

Touch the REC touch button, to enter the Sample Rec page.

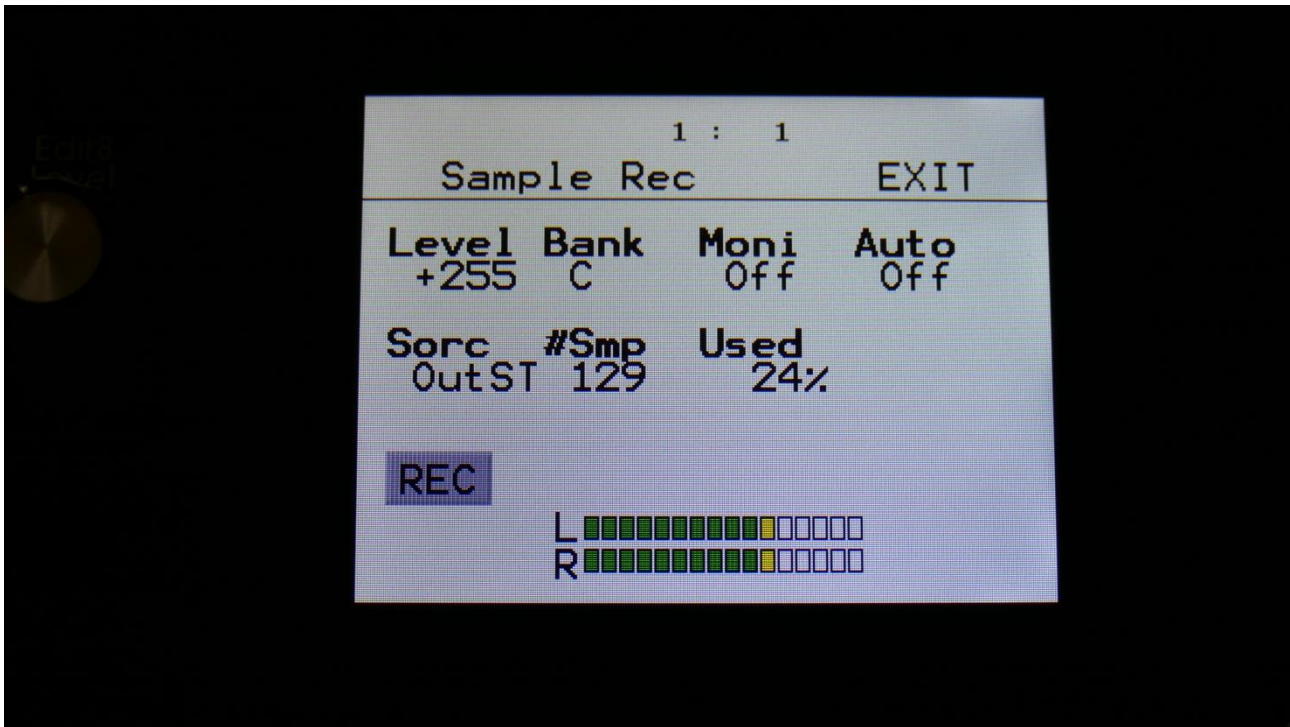

OR, from any page:

-Push and release the Func/Mute button, so it is lighting up.

-Push step button 12, marked "Sample/Qrec".

This will also get you to this page, just much faster.

If you can already hear the source, that you would like to record, leave the Moni parameter Off. If you have the record source connected directly to any of LD3's audio inputs, and can't hear it now, switch the Moni parameter to On.

Select the record source, by setting the Src parameter.

Choices are:

InpL : Left audio input mono

InpR : Right audio input mono

InpST : Left and right audio inputs stereo

OutpL : Left audio output mono

OutpR : Right audio output mono

OutST : Left and right audio outputs stereo

Inp 3 : Audio input 3 mono

Inp 4 : Audio input 4 mono

In3+4 : Audio inputs 3 and 4 stereo

Outp3 : Audio output 3 mono

Outp4 : Audio output 4 mono

Ou3+4 : Audio outputs 3 and 4 stereo

Inp 5 : Audio input 5 mono
Inp 6 : Audio input 6 mono
In5+6 : Audio inputs 5 and 6 stereo
Outp5 : Audio output 5 mono
Outp6 : Audio output 6 mono
Ou5+6 : Audio outputs 5 and 6 stereo

Now select the sample bank, that you would like to record to, setting the Bank parameter to bank A, B, C or D.

When choosing a bank, the **#Smp** parameter will show how many sampling that the selected bank already holds, and the **Used** parameter will show how many percent of the sample bank, that are already in use.

For optimal results, set the level parameter to +0, and adjust the level of the record source, so that the 2 VU-meters in the bottom of the screen does not get red.

You should only adjust the level parameter, to other values than +0, if it is not possible to adjust the level directly on the source.

When you are ready to record the sampling, touch the "REC" button in the lower left corner. If you have the Auto parameter set to anything else than Off, it will now write: "Waiting for trigger", until a signal that is loud enough to trigger the auto offset applied. Otherwise LD3 will now start to record the new sampling:

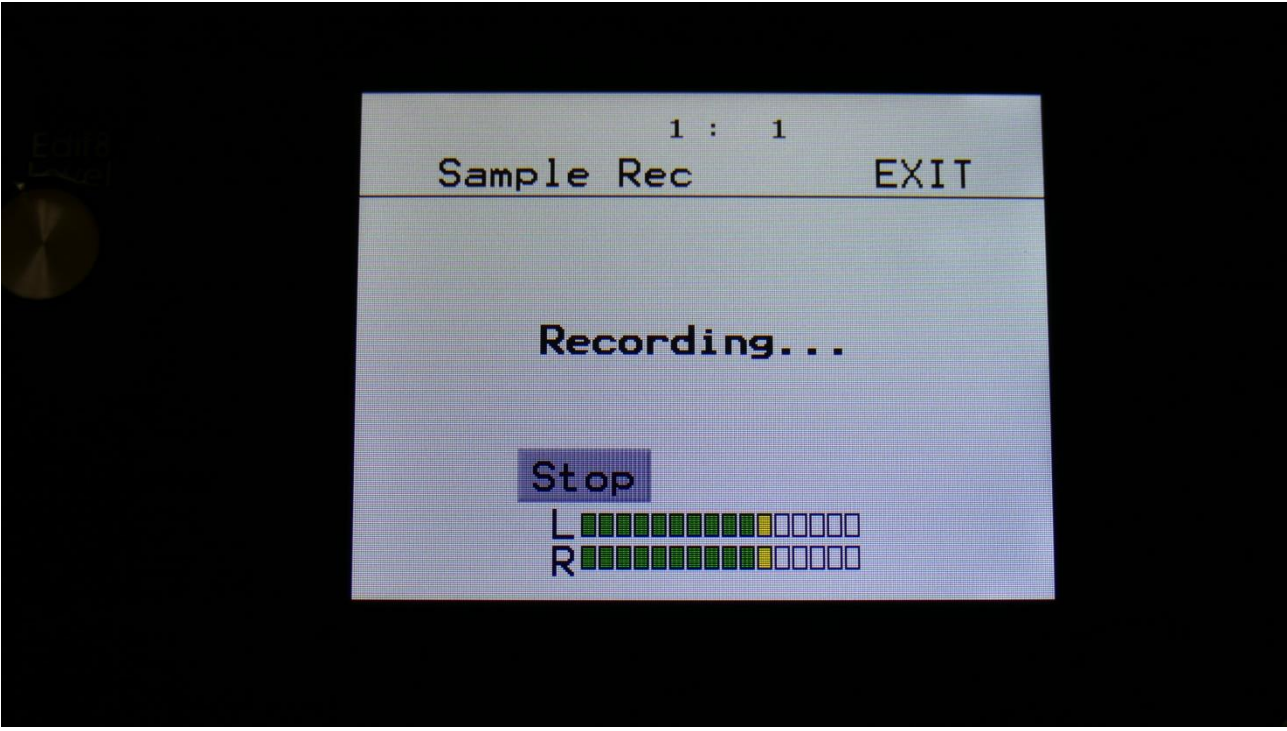

When you are finished recording your sample, touch the "STOP" button.

LD3 will now jump to this screen:

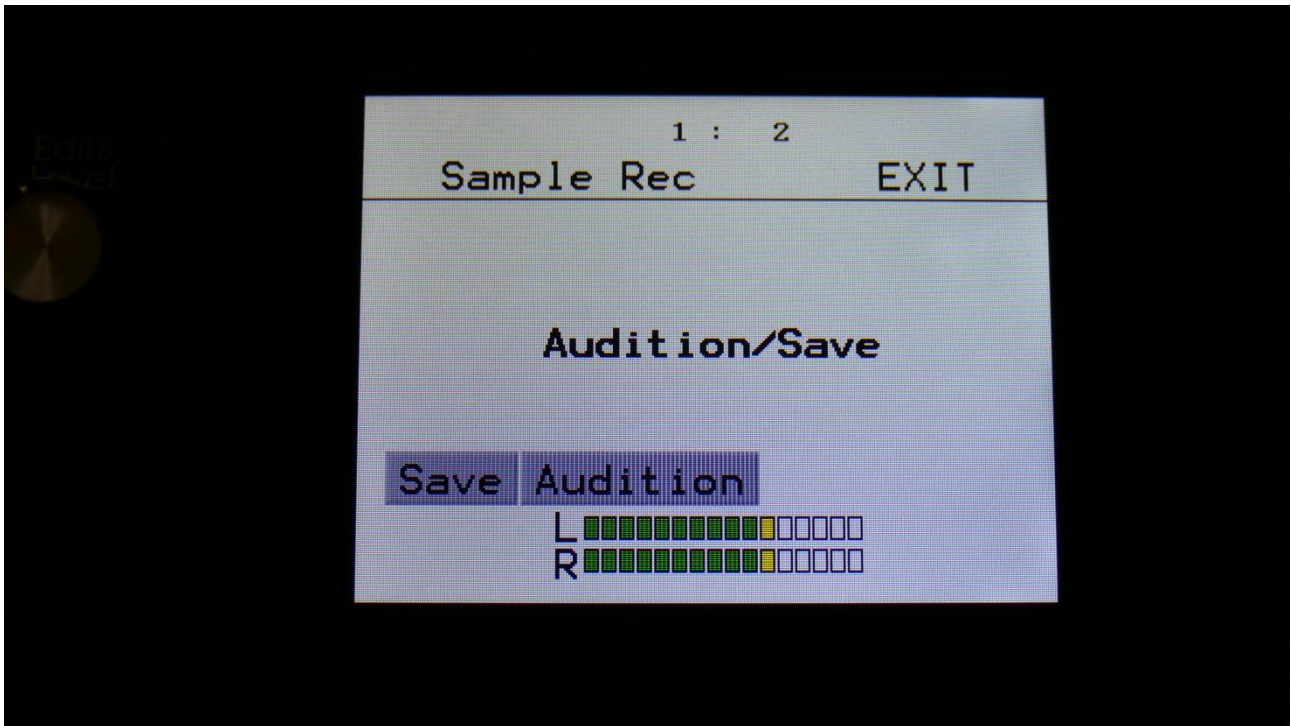

To audition the sample you have just recorded, touch the "Audition" button.

To name and save the sample, touch the "Save" button.

If you decide not to keep this sample, touch EXIT, and the new sample will be erased.

If you touch the "Save" button, LD3 will jump to this page:

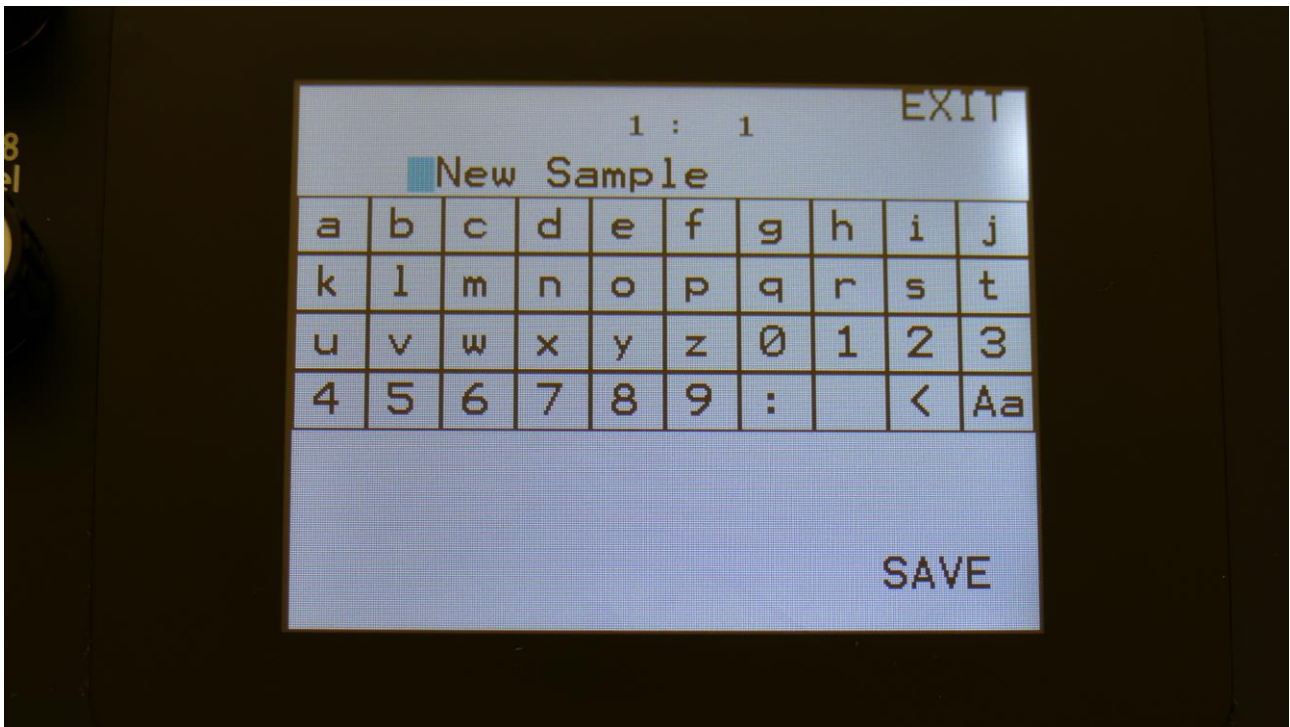

Type in the name for your sampling. This can be up to 16 characters long.
"Aa" will switch between uppercase/lowercase letters, and numbers/signs:

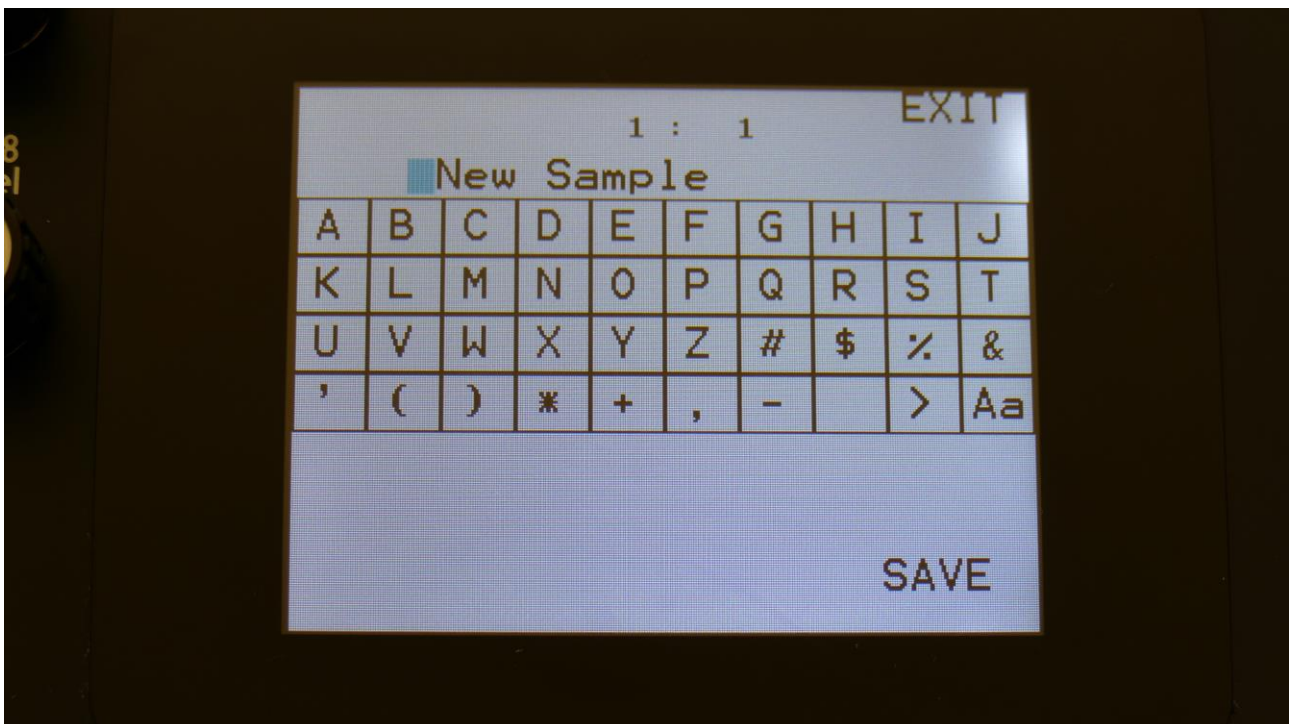

"<" will move the cursor back, for correcting characters, ">" will skip characters.

Touch SAVE, to save the new sample, and return to the Sample Rec page.

Edit A Sampling

From the Main Synth page, touch SMP at the top navigation bar., to enter this page:



OR: Hit the Func/Mute button, so it lights up, hit step button 12 "Sample/Qrec", and hit step button 16 "Exit".

On this page you can audition samples from the FLASH memory, adjust the samples start and end points, and create sample chops.

To audition the samples that your LD3 holds, touch the **Sample** name, and the Sample Select screen will appear:



Touch A, B, C or D to select sample bank A, B, C and D, touch PREV and NEXT to view the previous or next 16 samplings.

To select a sampling, touch the sample name. To audition it, touch the Play touchbar in the bottom of this page.

When you have found the right sampling, touch OK to return to the Sample Edit page.

The Play touchbar on the sample select page re-triggers the sampling every time it is touched. If you should wish to start and stop sample playback, every time you hit play, exit to the Sample Edit page, and touch the Play button there.

Adjusting the start and end points of a sample

If a sample has silence at the start and/or end of it, or if there are parts of a sample you do not intend to use, it might be necessary to adjust the start and end points of it.

To do this, select the sample you would like to adjust.

Adjust the start point by turning edit knob 1, fine adjust by turning edit knob 2.

Adjust the end point by turning edit knob 3, fine adjust by turning edit knob 4.

Audition by touching the PLAY button.

When you are satisfied with the result, touch the SAVE button.

LD3 will now show:

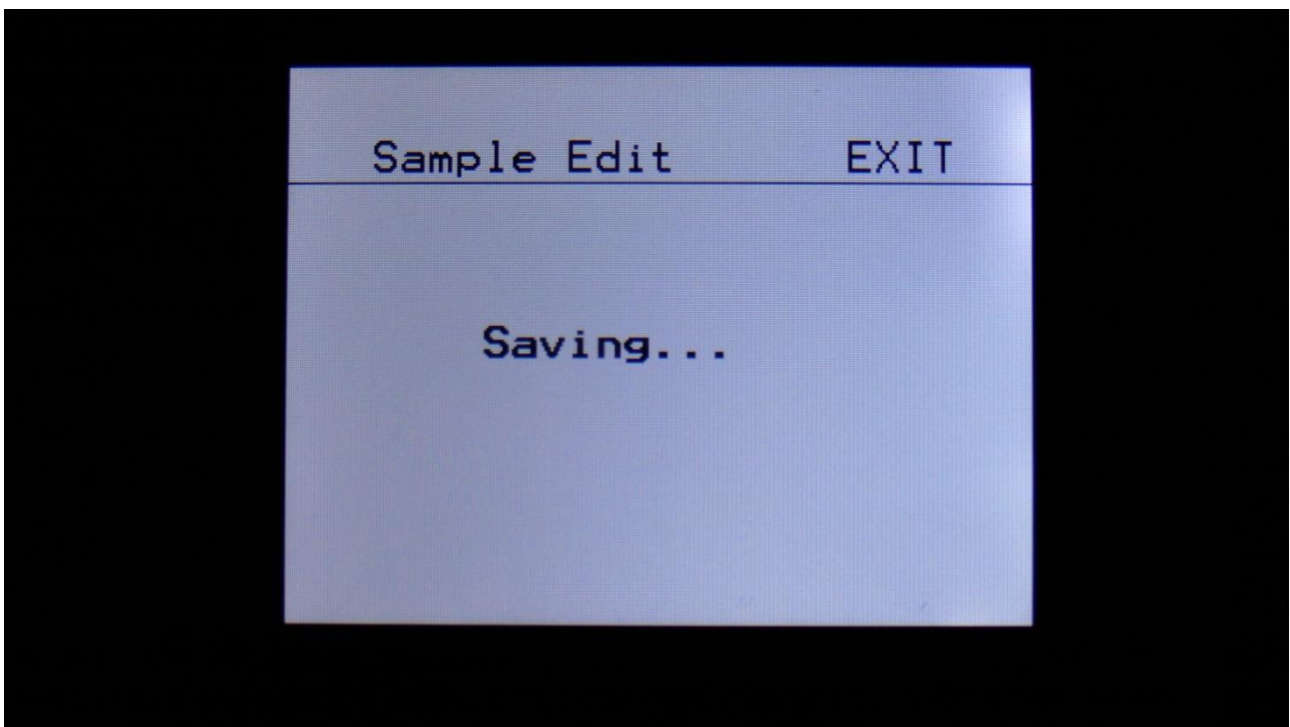

Instead of searching manually for the sample start point, it is possible to use the Chop function for this. This is described in the "Sample Chops" section, that starts on the next page.

Sample Chops

On LD3 it is possible to add chop points to a sampling, in order to make it play back a certain portion of the sampling at a time. Sample chops are generated in the Sample Edit section, to be used by the samplers in the Synth section.

This function could be used for the classical separating single drum hits from a beat, or to find the startpoint of a sampling in a fast way, if the chop function is set up for peak detection.

The chop function of LD3 isn't though limited to this. On LD3 it is also possible to make the chop function find "wave chops". This function will pick out single wave cycles of the sampling, and create chop points for these. In the samplers of the synth section, it is then possible to select these wave cycles, loop them, and switch between other wave cycles of the sampling. This can also be used as a super easy way for looping a sampling.

All chop points are non-destructive to the sampling. Only the positions of the chop points are stored, nothing is changed on the sampling itself. Chop points can, at any time, be moved, deleted and inserted.

Up to 64 chop points can be created for each sampling.

Another way to create chop point, are to use the "Import Samplings From Dir As Chop Points", described in the USB section of this manual.

If you have already created chop points on a sampling, in a computer program that uses cue points, like FL Studio, or any other gear that generates cue points, LD3 will import these as chop/loop points. When you exports LD3 samplings via USB, any generated chop points will also be exported as cue points, for use in other gear or computer programs.

Remember to save the chop points. Else they will be lost!

To create and/or edit sample chop points, from the Sample Edit page, touch the **Chop** touchbutton, to enter this page:

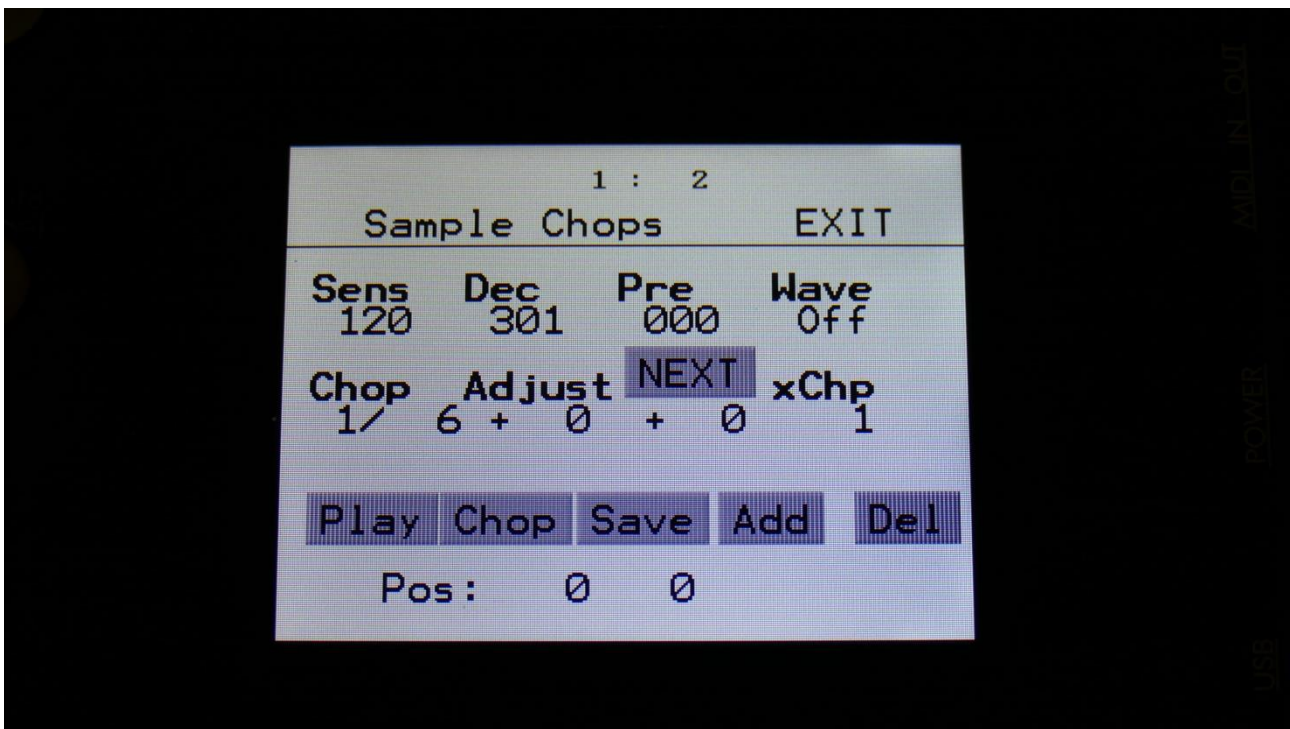

The parameters of this page:

Sens: Adjust how loud the level of the sample audio should be, before it detects a chop point. If it creates too many chop points, turn this parameter up a bit. If it creates too little or no chop points, lower this parameter.

Dec: Chop envelope decay. This adjusts the decay time of the chop detection envelope in a reverse manner. The lower the value, the slower the decay. If the sounds is recorded with very little or no silence between them, like in a beat, this needs to be set to a high value. If there's a good gap of silence between the sounds, set it to a low value.

Pre: If there are loud clicks in the start of many of the chop points, especially on low frequency sounds, turning up this parameter will make LD3 set the chop points a little bit earlier, than it usually would. This will remove these clicks.

Wave Mode: Switches the chop wave cycle mode on and off.

Chop: Select a chop number for auditioning. Total number of chops is shown right after the /.

Adjust: (2 parameters). For adjusting the selected chop forward (positive values) or backwards (negative values).

xChp: Number of chops in each chop point. Turning this up, before generating chops, will make each chop contain a number of chops. Especially usefull, when using the wave chop function for making sample loop points.

Generating Sample Chop Points

On the Sample Chops page, adjust the Sens, Dec, Pre and xChp parameters as desired, and switch wave mode on if desired.

Touch the **Chop** button.

LD3 will now look for chop points, in the selected sampling:

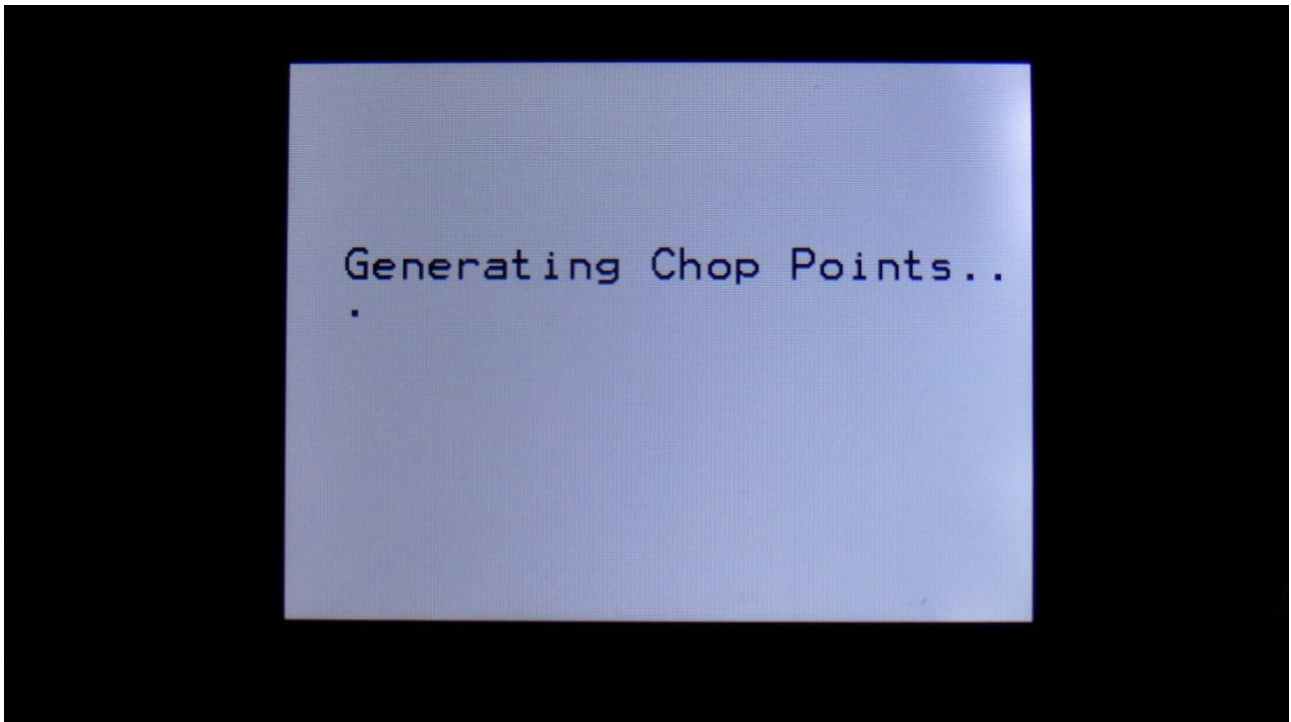

When it is done, it will jump back to the Sample Chops screen:

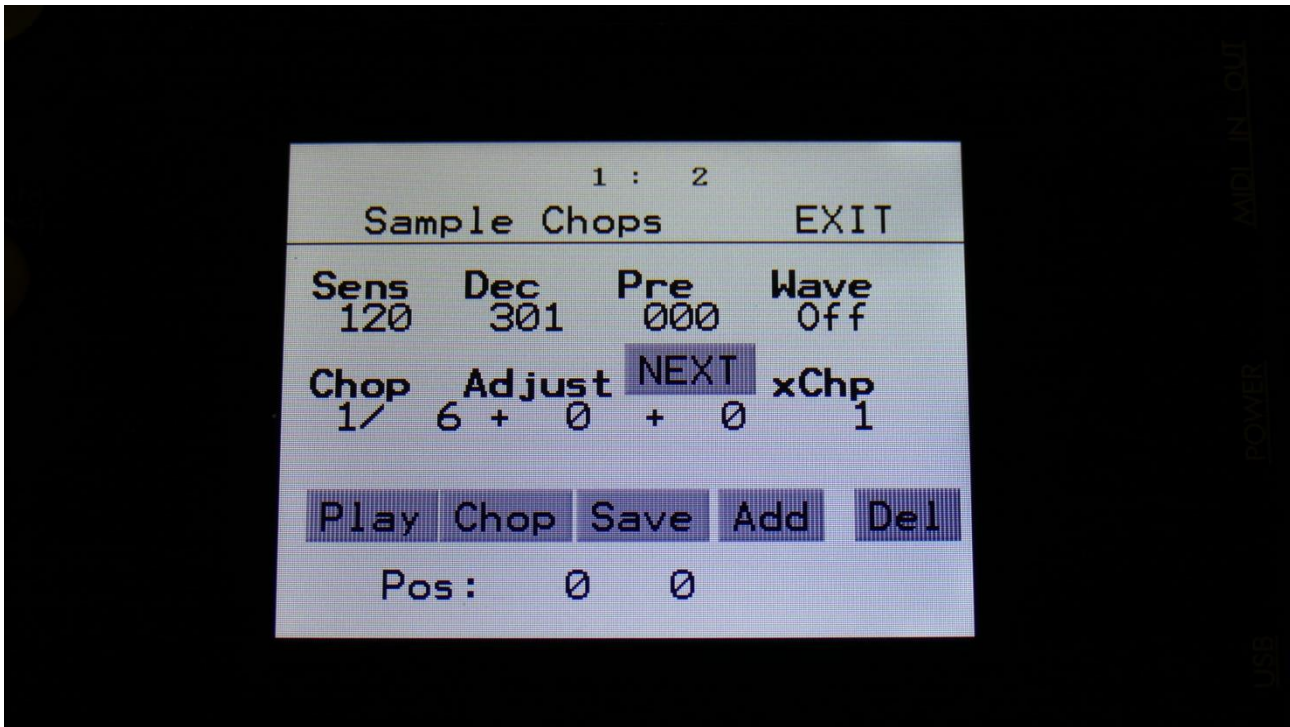

By adjusting the Chop parameter, it is now possible to select and audition the chop points that LD3 has found.

Audition the chop points by hitting the “Play” button. If some chop points are not exactly where you would like them to be, adjust them with the Adjust parameter. If some chop points shouldn’t be there, delete them by hitting the “Del” button.

It is also possible to adjust the end point of the chop point. Simply touch the **NEXT** button. Now, while auditioning the selected chop point, you can adjust the next chop point, which is also the end point for the selected chop point, using the Adjust parameters.

To add chop points, first touch the “Play” button, to make the sample/chop point play back. While the sampling is playing back, hit the “Add” button when it is playing back the point, where you would like to add a chop point.

In the bottom of the screen, it shows the position of the selected chop, in the values that the **Sample Start** parameters would have to be adjusted to, to select this point of the sampling. So if you don’t want to use the chop points anyway, but just wants the sample playback to start at this point, you can exit to the Sample Rec page, and set the Sample Start point to this value.

When you are satisfied with the chop points, remember to hit the “Save” button to keep them. The chop points are saved together with the sample data, and are also imported/exported via USB as cue points.

Wave Chop System

This system can take any of the samplings held in your LD3, and chop it up in, up to 64, single cycle waves.

If you already have a library of single cycle waves in .wav format, you can use the “Import Samples From Dir As Chops” function, to import the single cycle waves into one sampling with wave-chops.

When you have a sampling with the wavechops added, it is possible, in real time, to select which single cycle should play back, in the samplers in the synth section, using the “Chop” parameter. It is also possible to select single cycle waves, using any modulation source.

This gives some really cool possibilities, like wave sequencing, wave tables and time stretch.

How to wave chop a sampling:



On the sample Edit page, select the sampling, you would like to wave chop, and touch “Chop”.

That will get you to the Chop page:

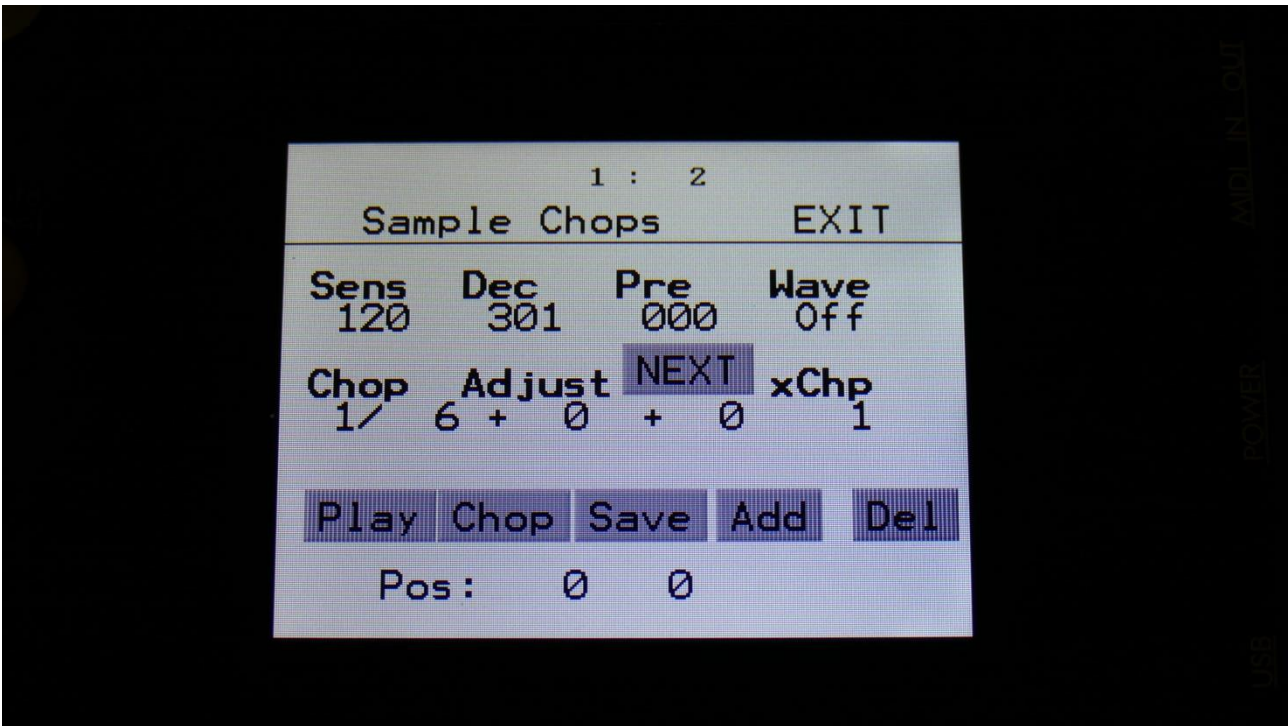

Set the Wave parameter to On.

When in Wave chop mode, the Dec parameter functions in the opposite way, as when in normal chop mode. The lower the value, the faster the decay.

A good startpoint for wave chopping is to set Dec to 1 and Sens to 128. If the wave chops gets too long (very few chop points), try first to adjust Sens down. If this makes things worse, adjust it up. On simple waveforms, Sens should, in most cases, have a low value. On more complex waveforms, Sens should have a higher value.

If you wish your wavechops to be larger than single cycles, you can either turn Dec or xChp up.

The Pre parameter should be kept at zero.

When you have switched Wave on, and adjusted the settings, touch the "Chop" button.

LD3 will now show:

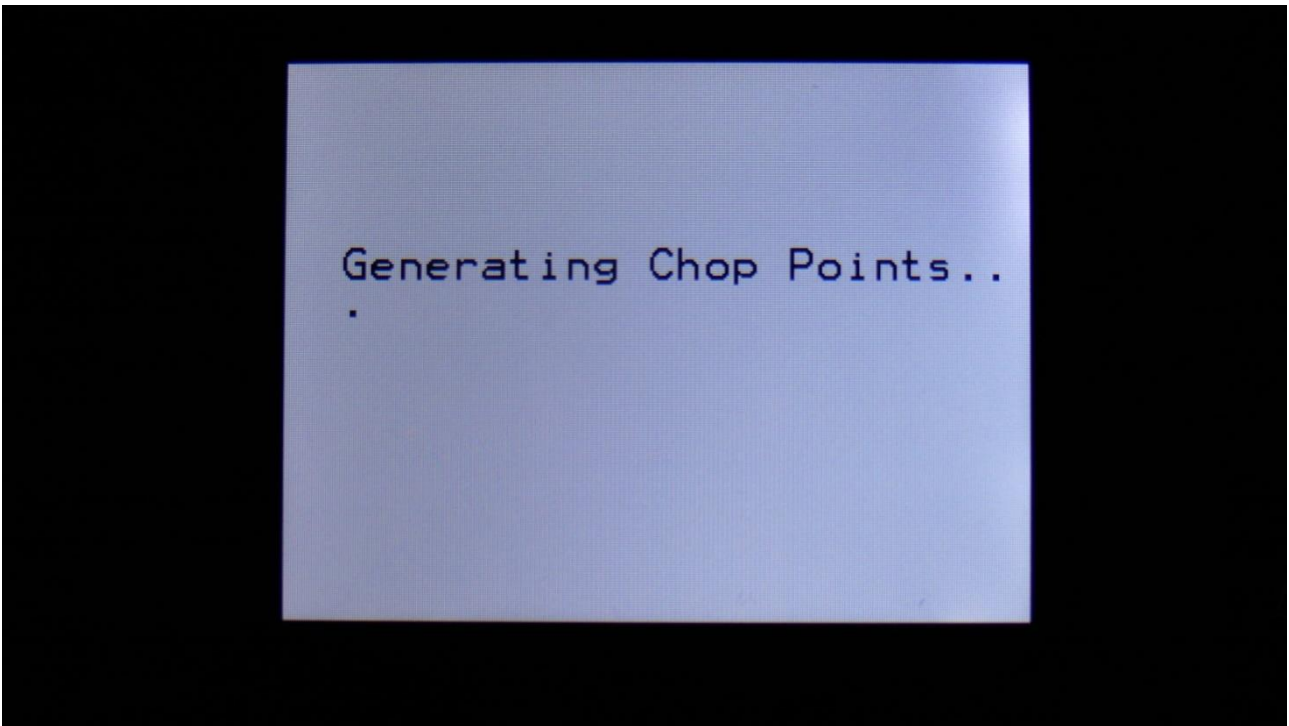

When it has found some chop points, it will return to the Chop page:

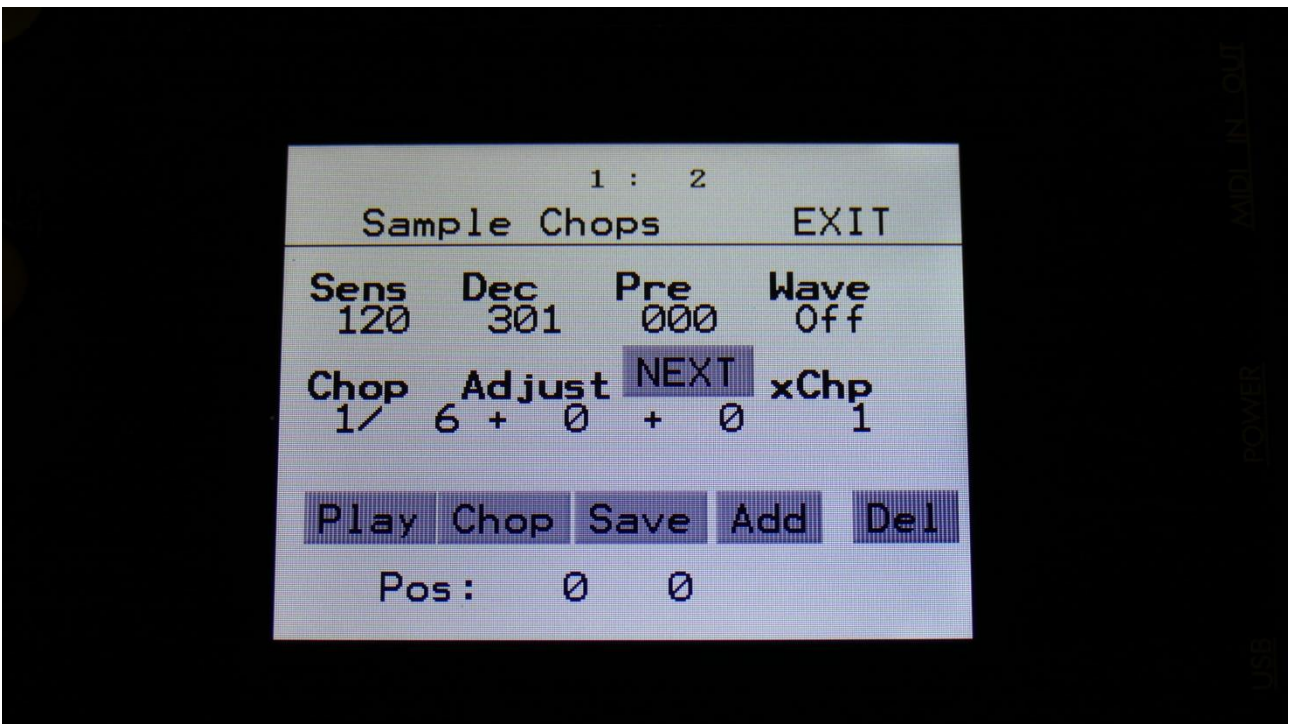

Now touch the play button, and select chops by adjusting the Chop parameter, to audition the result.

If you are not satisfied with the result, re-adjust Sens, and hit Chop again.

When you have found a result, that you are satisfied with, please remember to touch the “Save” button.

To use the wave chops for something, now exit Sample Edit, and go to a part Osc page.



Set Osc1 in sampler mode, and touch the SMP touch button to select the sampling, that you just wave chopped (or any other sampling that you have wave chopped).



Touch the sample slot 1 name, to open the sample select page.

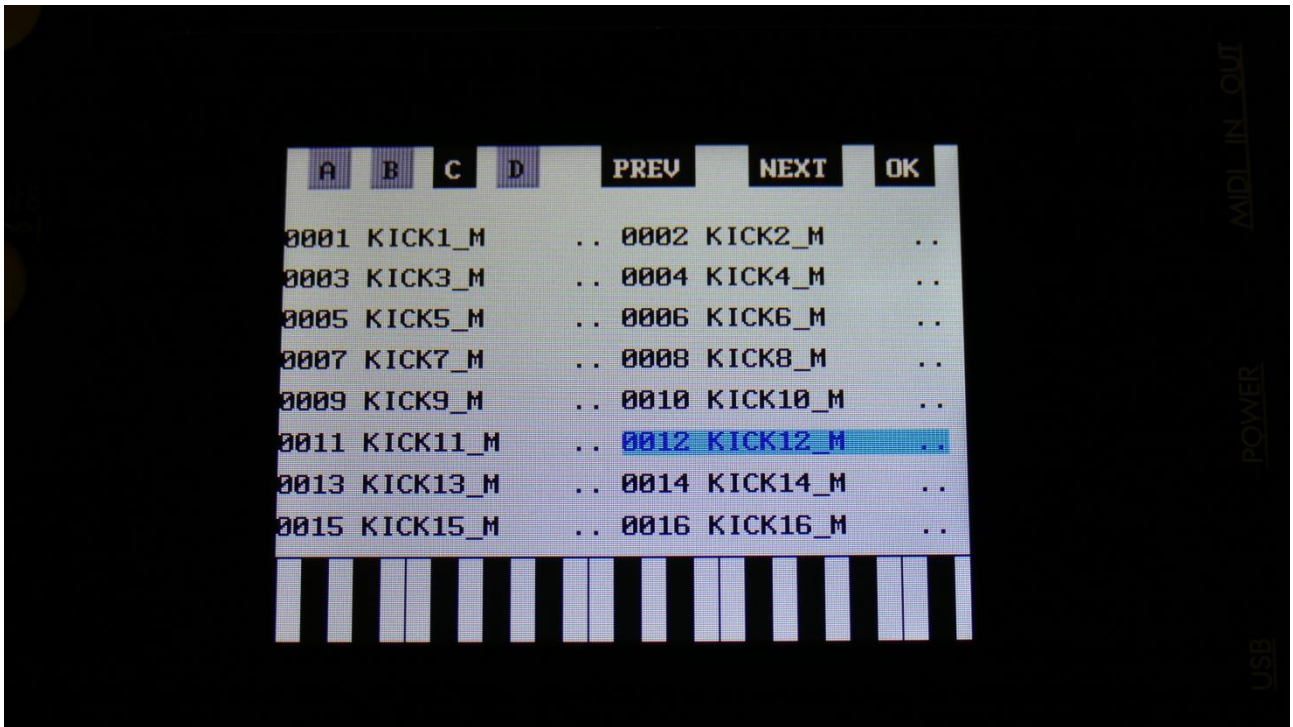

Select the sampling, touch OK, and touch the OSC touchbutton.

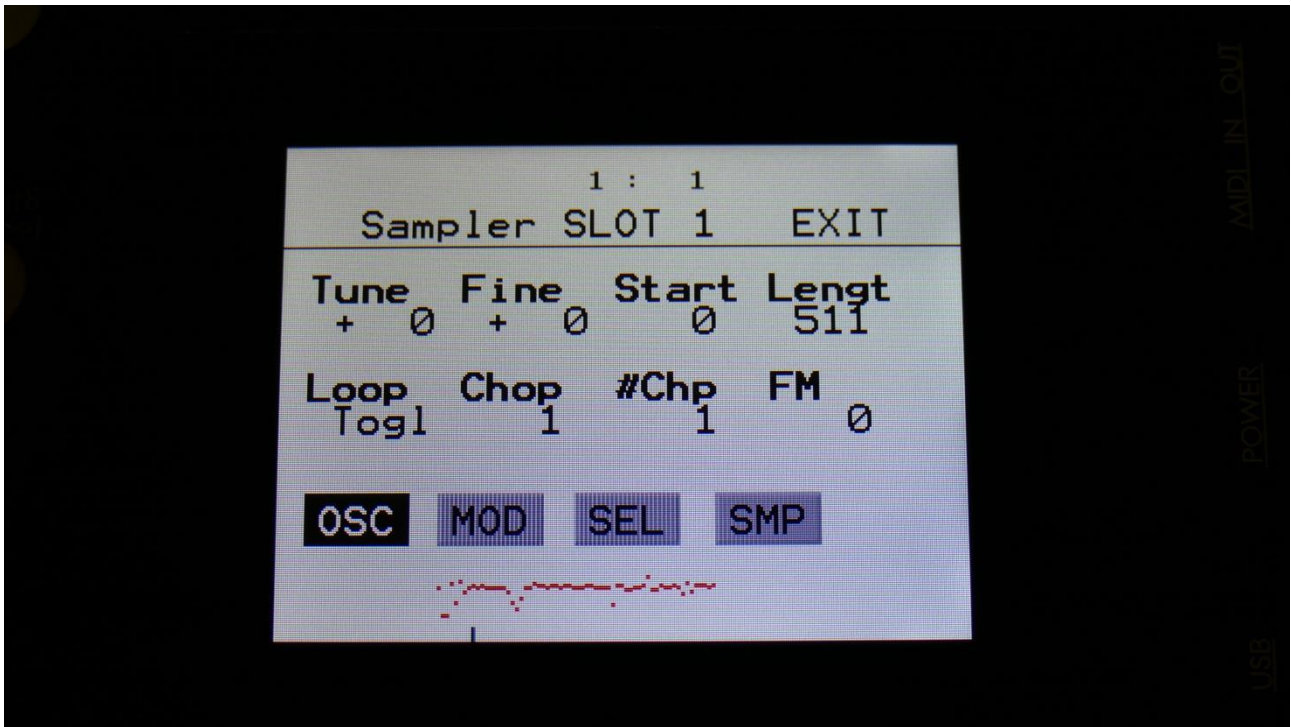

Set Loop mode to On, and adjust the Chop parameter, to select the single cycle waves. If you would like more single cycle waves to play back inside the loop, turn the #Chp parameter up.

Modulating the Chop parameter



Unlike most other parameters in LD3, only positive modulation are applied to the Chop parameter. So the Chop parameter selects the lowest possible chop to be played back.

Time Stretch

To time stretch a wave chopped sampling:

- Set the Chop parameter to 1.
- Set up Envelope 1- (Envelope 1 inverted) to modulate the Chop parameter, and turn the modulation amount up. You can obtain different effects, with different values of the modulation amount.
- Adjust the Envelope decay, to make the playback of the sampling faster (low decay values) or slower (high decay values).
- Adjust the attack parameter, to obtain a reverse playback effect, in the start of the sample playback.
- Modulate the envelope parameters, to have dynamic sample lengths.
- The sampling will play back at the exact same speed, over the entire keyboard range, regardless of the sample pitch.

Deleting last recorded sampling

On the Sample Delete page, it is possible to delete the last recorded sampling in sample Bank A, B, C or D. On the sample select page, select the sample bank, from which you would like to delete a sampling.



Touch DEL.

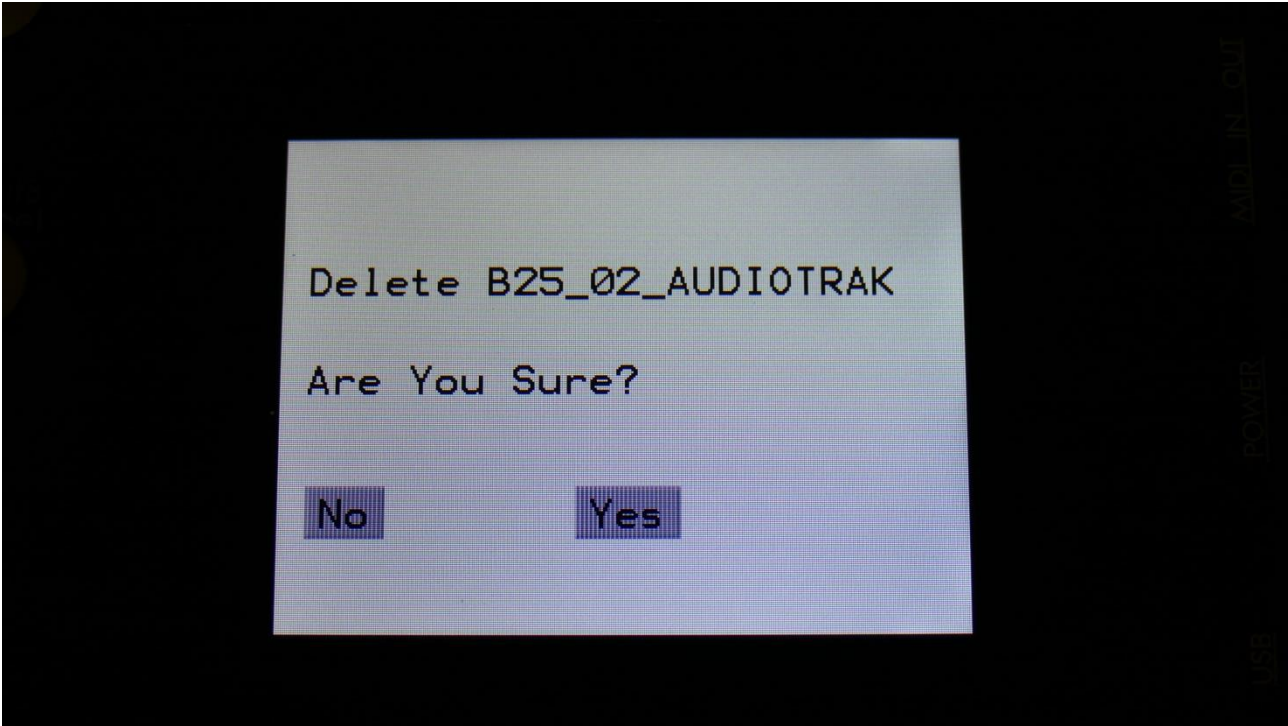

To delete the sample, touch "Yes".

If you regret, touch "No", to return to the Sample Edit page.

Deleting other samplings, than the last recorded one

Because of some security features of the flash memory used in LD3, it is only possible to directly delete the last recorded sampling in each bank.

By using its USB functions (explained in the next chapter of this manual), it is though possible to delete other samplings.

To delete another sampling:

- Connect a USB drive, that you have tested to be working (try to import some samplings from it), to the LD3 USB port.
- Create a new directory.
- Export all your samplings of the bank, where the sampling(s) you want to delete is located, to the USB drive, inside the new directory.
- Enter the directory, on the USB drive, and select the sampling(s), that you want to delete.
- Push "MD/del" on the USB page.
- Push "Del".
- Confirm.
- Leave the USB pages, go to the "More..." section, and delete the whole sample bank.
- Go back to the USB page, and select the directory, holding your samplings.
- Push "Import", and then "Re-Load".
- LD3 will now put your samplings back on the right place, except for the sampling(s), that you deleted.

Graphical sample editing



On the Sample Edit page, the touch button previously named “Func”, has been renamed to “Grap”.

Touching this will enter the graphical sample edit pages.

On the graphical sample edit pages you can add and remove chop/loop points and select a portion of a sampling, to be saved as a new sampling.

It has also been made easier, to set loop points in long samplings, by making it possible, to save the selected end point as a chop/loop point.

From the Sample Edit page touch Grap, to enter the graphical edit page:

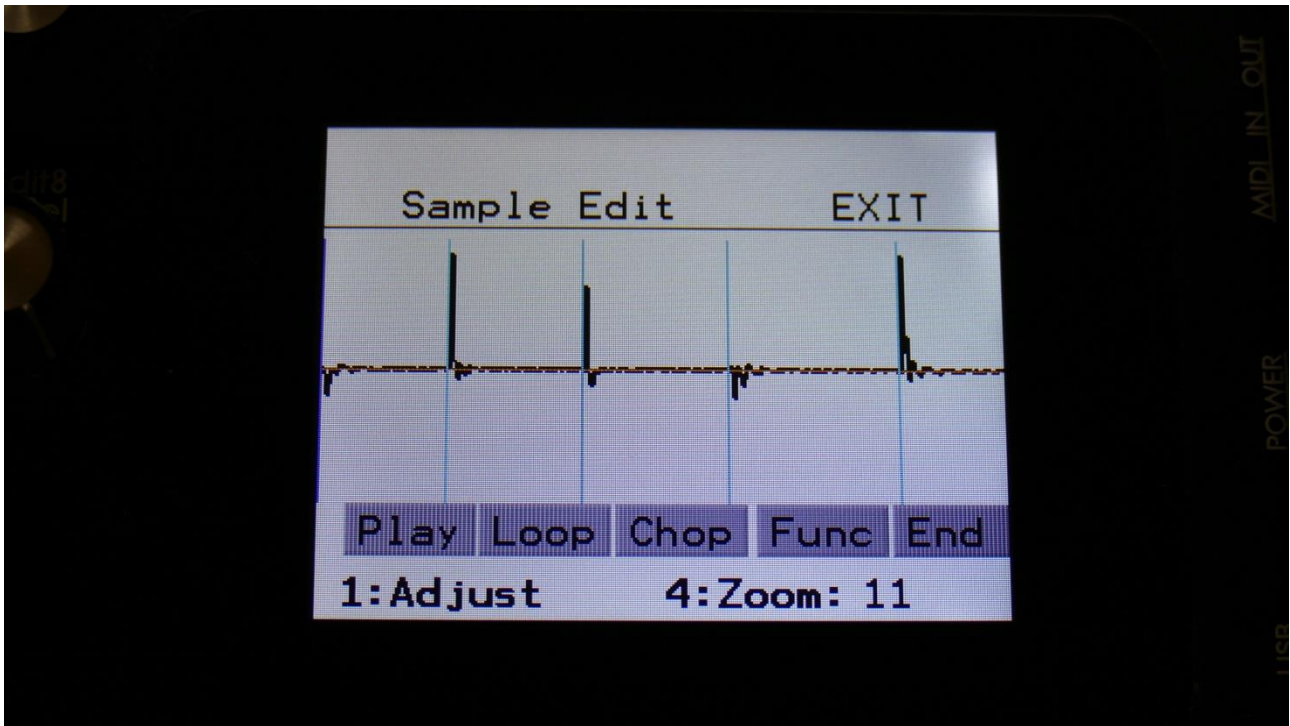

On this page, you will see a graphical presentation of the selected sampling. Chop points are indicated as vertical blue lines, and the sample zero point is indicated as a horizontal red line.

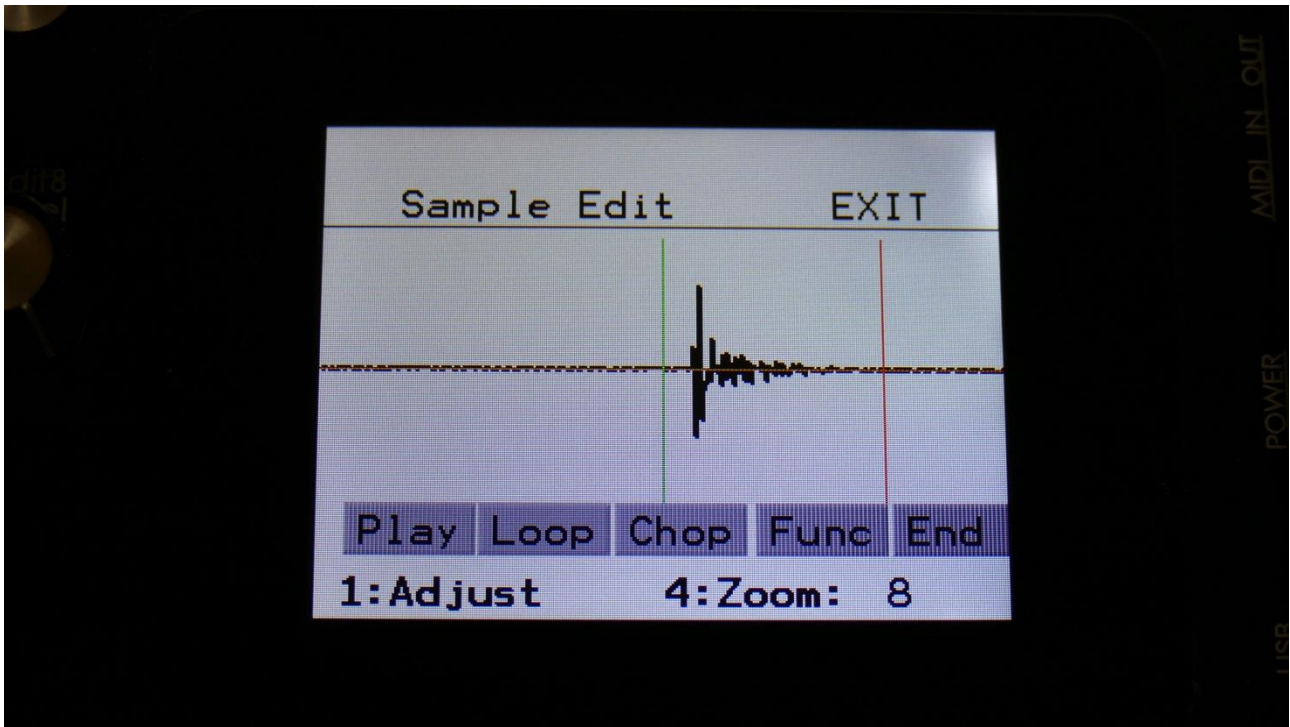

By touching anywhere on the screen, or by rotating Edit Knob 1, you can select a start point. This is indicated by a vertical green line.

By rotating Edit Knob 4, you can zoom in and out.

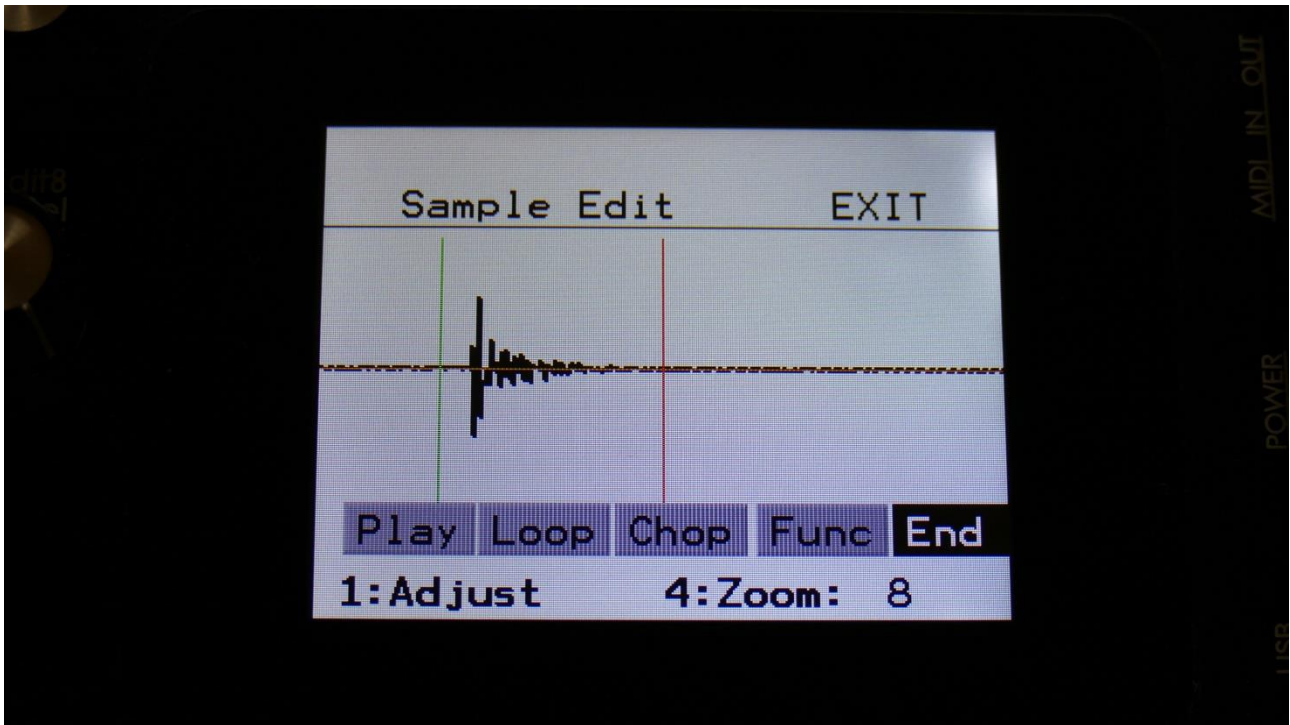

By touching the End touch button, so that it turns black, the screen will now be focused on the end point, which is indicated as a vertical red line. When you touch the screen now, the red line will move, indicating that the end point is selected. It is also possible to change the end point, by rotating Edit Knob 1.

If you touch the Play touch button, the sample will play back from the start point to the endpoint, and then stop.

If you touch the Loop button, so that it turns black, and then touch the Play button, the sample will play back from the start point to the end point, and then loop back to the start point, and play back the selected piece again, until Play or Loop is touched again, so that any of these turns grey.

Selecting and edit chop points

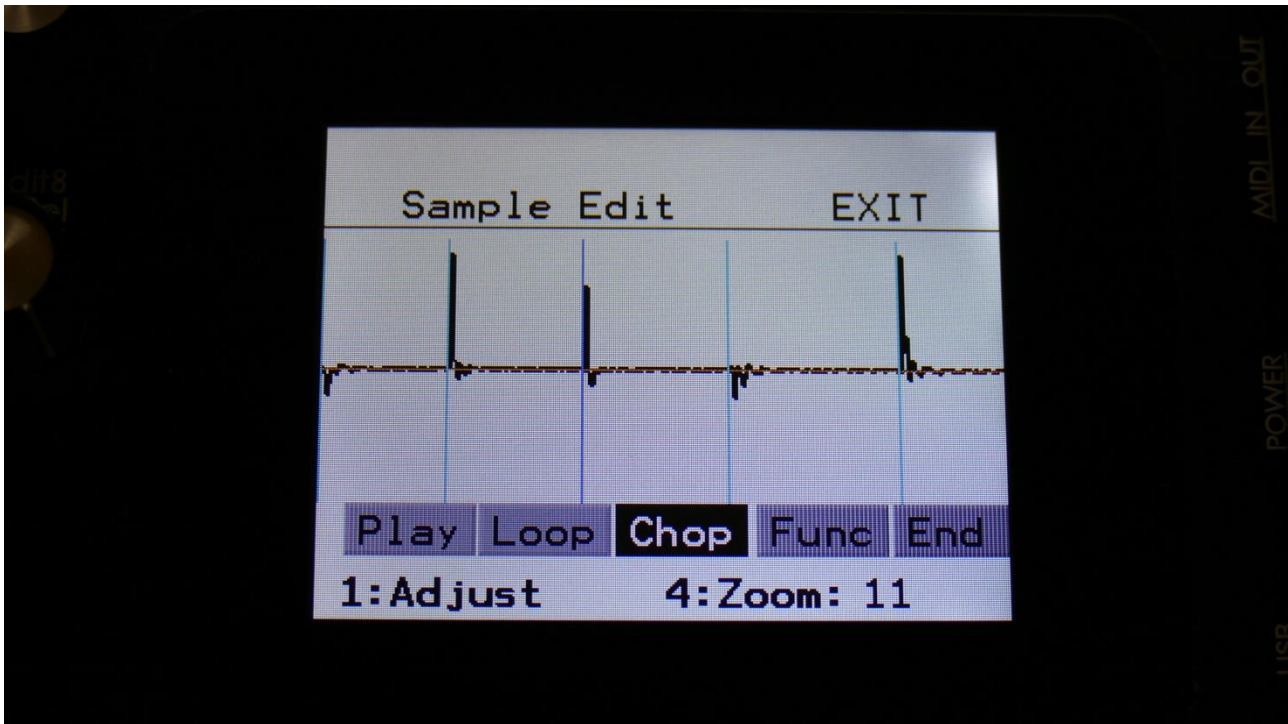

Touch the Chop touch button, so that this becomes black.

Now, when you touch the screen, you will select a chop point. The line indicating the chop point will turn dark blue, when it is selected.

Rotate Edit Knob 1 to adjust the chop point. Rotate Edit Knob 4 to zoom in and out.

If you touch the Play touch button, the sample will play back from the selected chop point to the next chop point, and then stop.

If you touch the Loop button, so that it turns black, and then touch the Play button, the sample will play back from the selected chop point to the next chop point, and then loop back to the selected chop point, and play back the selected piece again, until Play or Loop is touched again, so that any of these turns grey.

By touching the End touch button, so that it turns black, it is possible to adjust the next chop point, which is also the end point of the selected chop, by rotating Edit Knob 1.

Adding a chop point

Make sure that the Chop touch button is grey.

Set the start point, where you want the chop point to be, either by touching the screen, or by rotating Edit Knob 1.

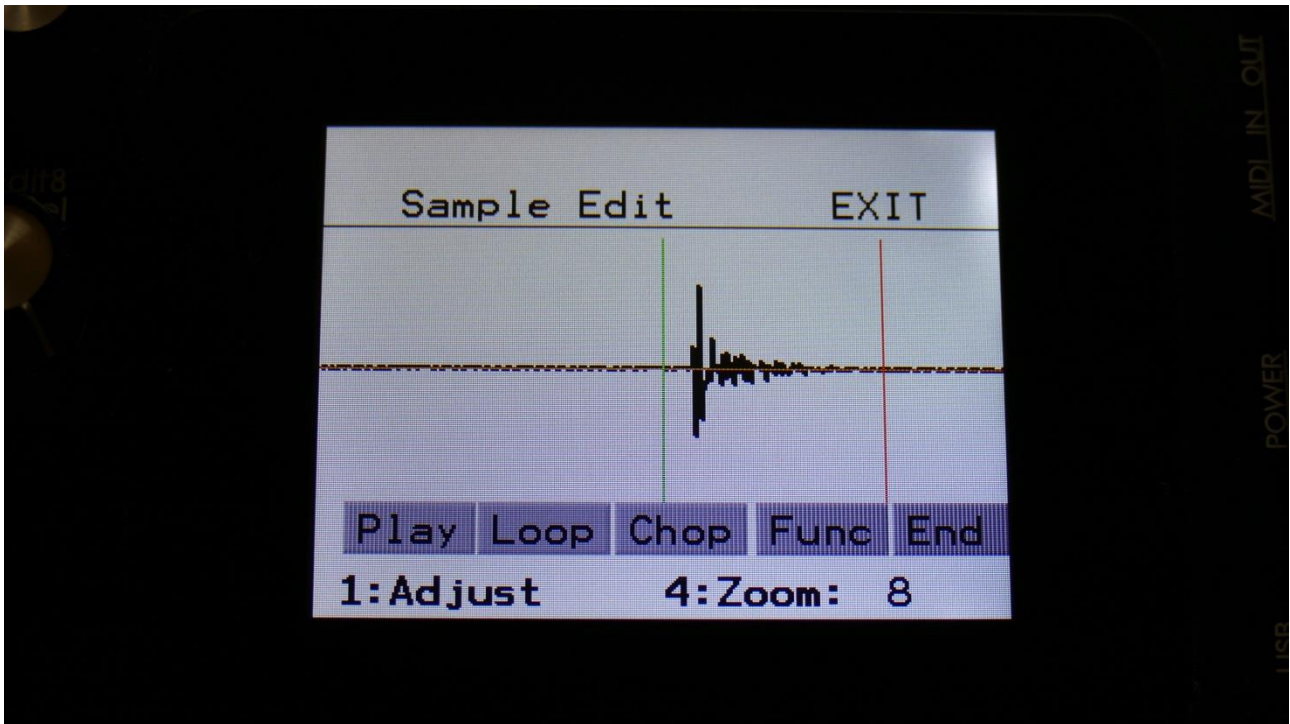

Touch the Func touch button.

Now you will enter the graphical function page:

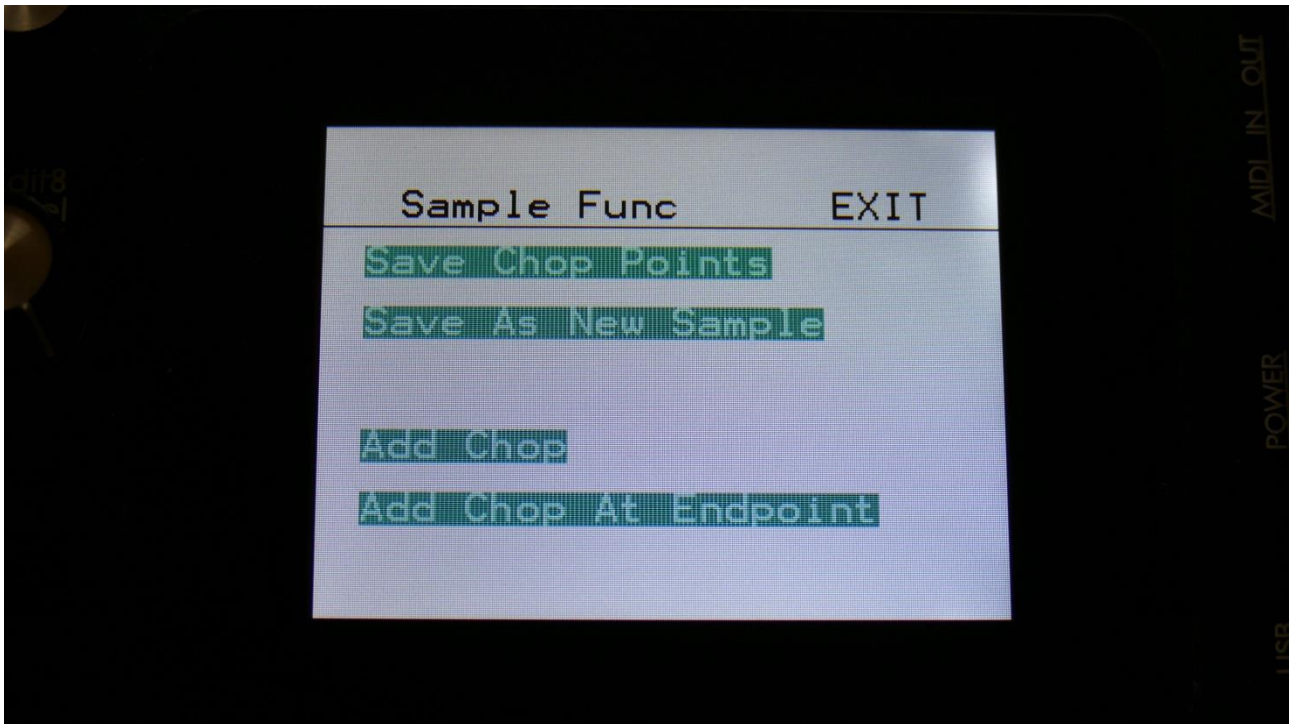

Touch "Add Chop". LD3 will now jump back to the graphical edit page, and a chop point will be added at the selected start point.

Adding a chop point at the selected end point

If you wish to create a loop, for instance for use with the sustained loop feature, you will adjust the start and endpoints, until the loop sounds as intended.

Then you will save the start point as a chop point.

In order to make the loop work, you will though also need to save the selected end point as a chop point.

To do this, you must enter the graphical function page again:

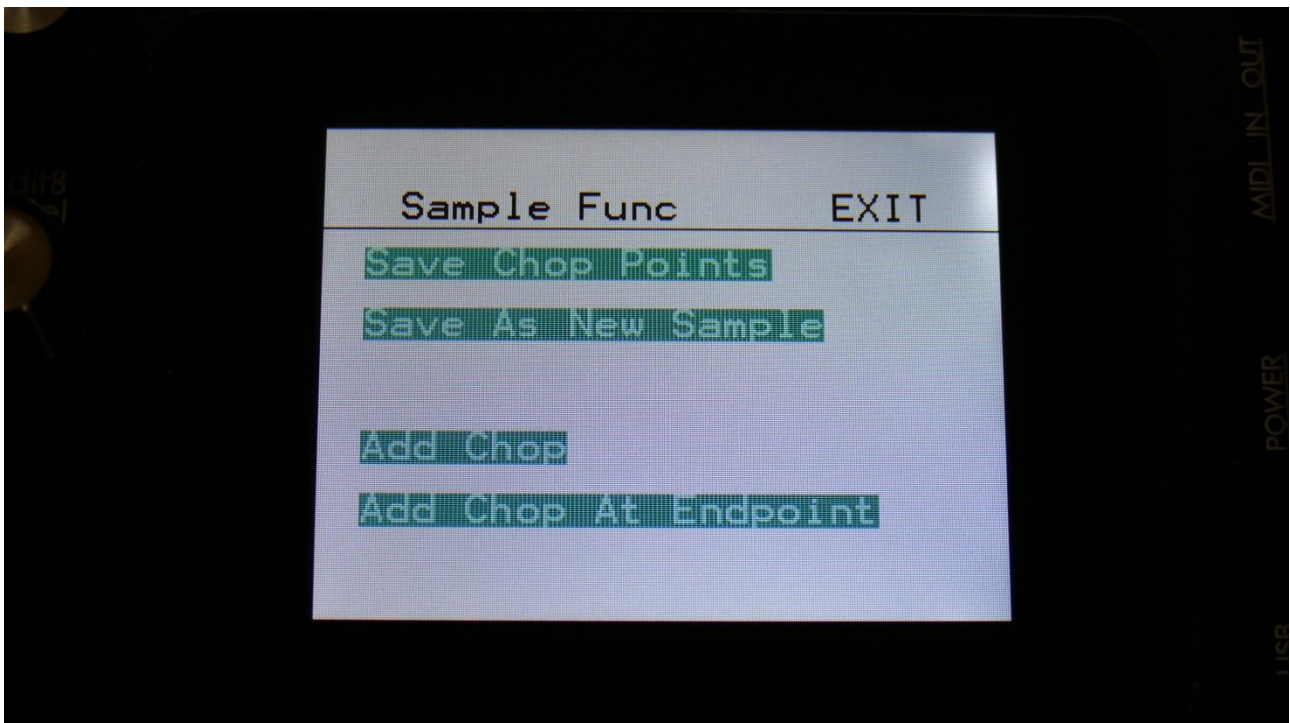

Touch "Add Chop At Endpoint". LD3 will now jump back to the graphical edit page, and a chop point will be added at the selected end point.

Delete a chop point

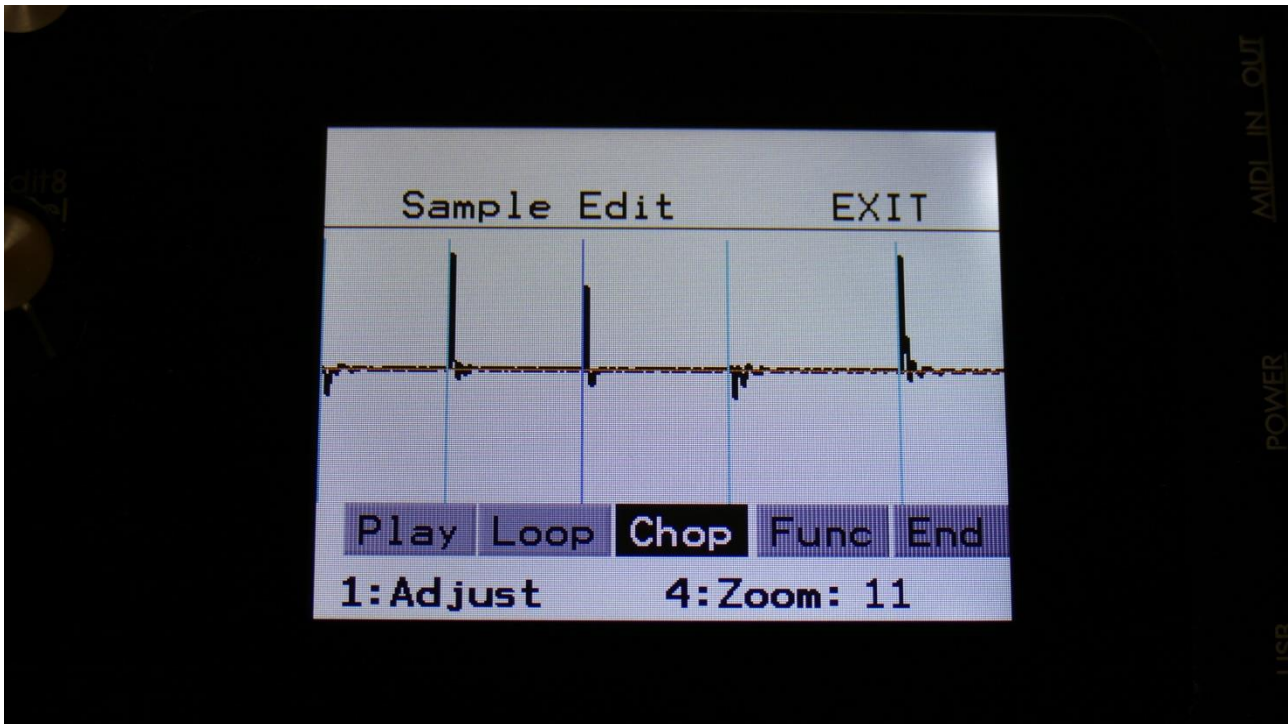

Make sure that the Chop touch button is black, and that you have selected the chop point, that you want to delete.

Touch the Func touch button, to enter the graphical functions page.

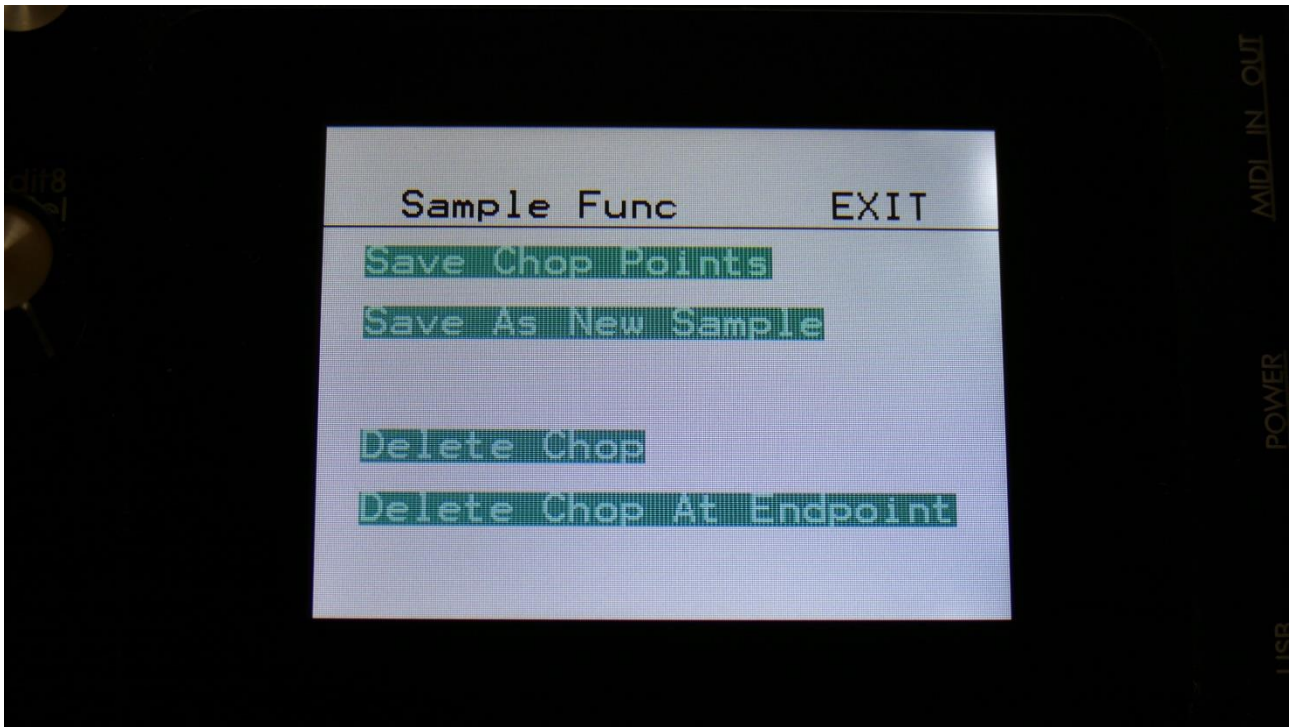

Now touch “Delete Chop”. LD3 will now jump back to the graphical edit page, and the previously selected chop point will have been removed.

To delete the next chop point, follow the same procedure, but touch “Delete Chop At Endpoint” on the functions page instead.

Saving the chop points

After you have edited, added and deleted chop points, you must save these changes, in order to keep them.

This is also done from the graphical functions page.

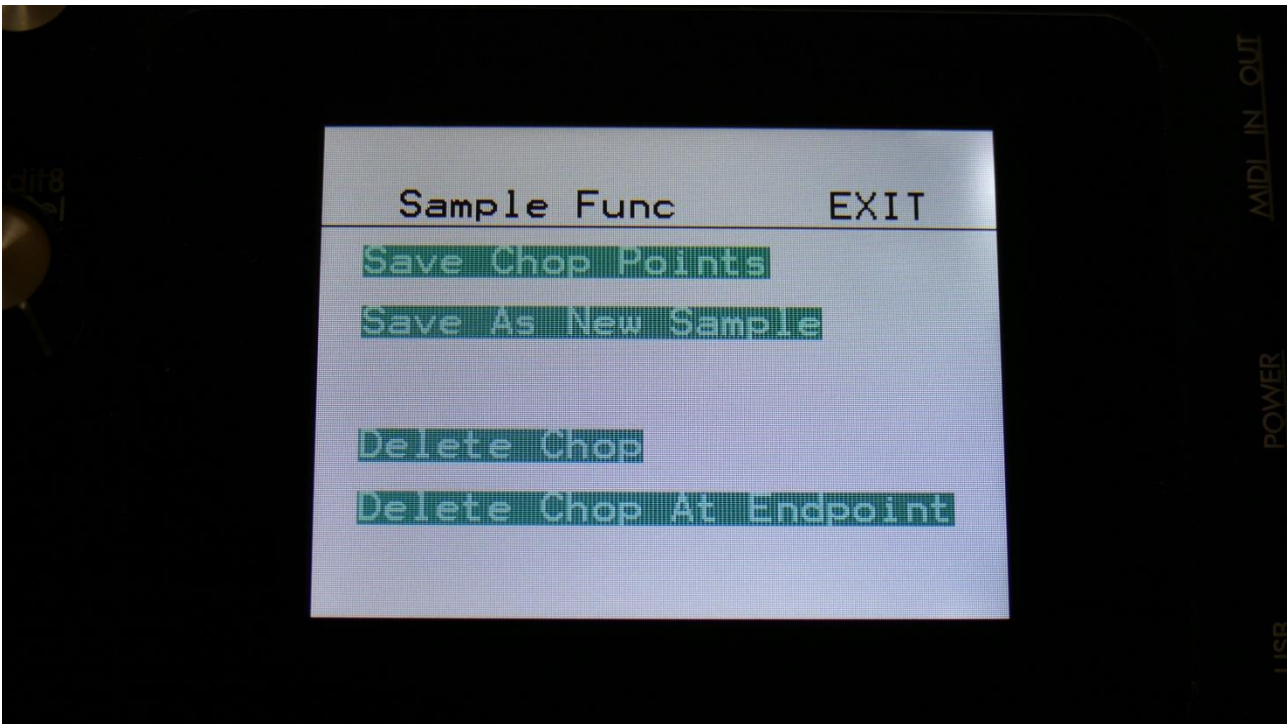

Simply touch "Save Chop Points". LD3 will now save your edits, and return to the graphical edit page.

Creating a new sampling from a portion of the selected sampling

If you want to completely remove unused start and/or end portions of a sampling, use a portion of the sampling for a loop, or just wants to copy the whole sampling to another sample bank, you can use this function.

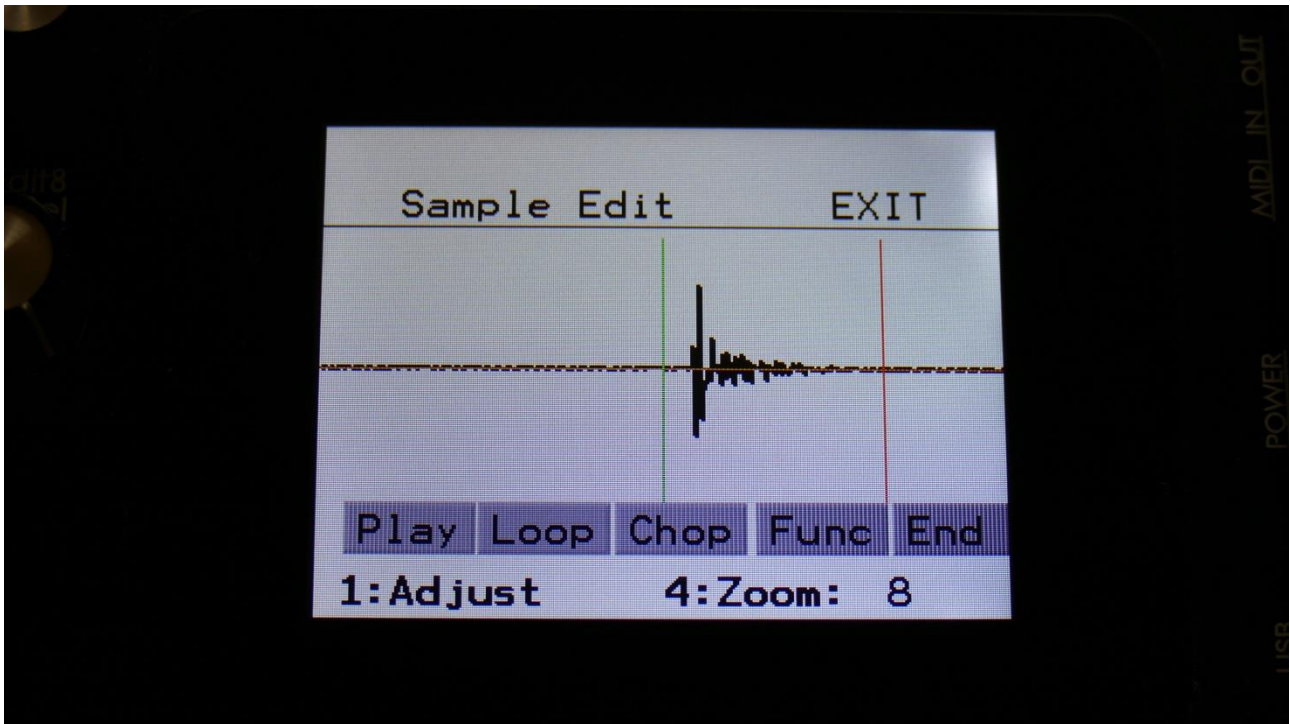

First, set the start and the end points, of the portion of the sampling, that you would like to copy, OR select a chop, if this is what you would like to copy.

Go to the functions page.

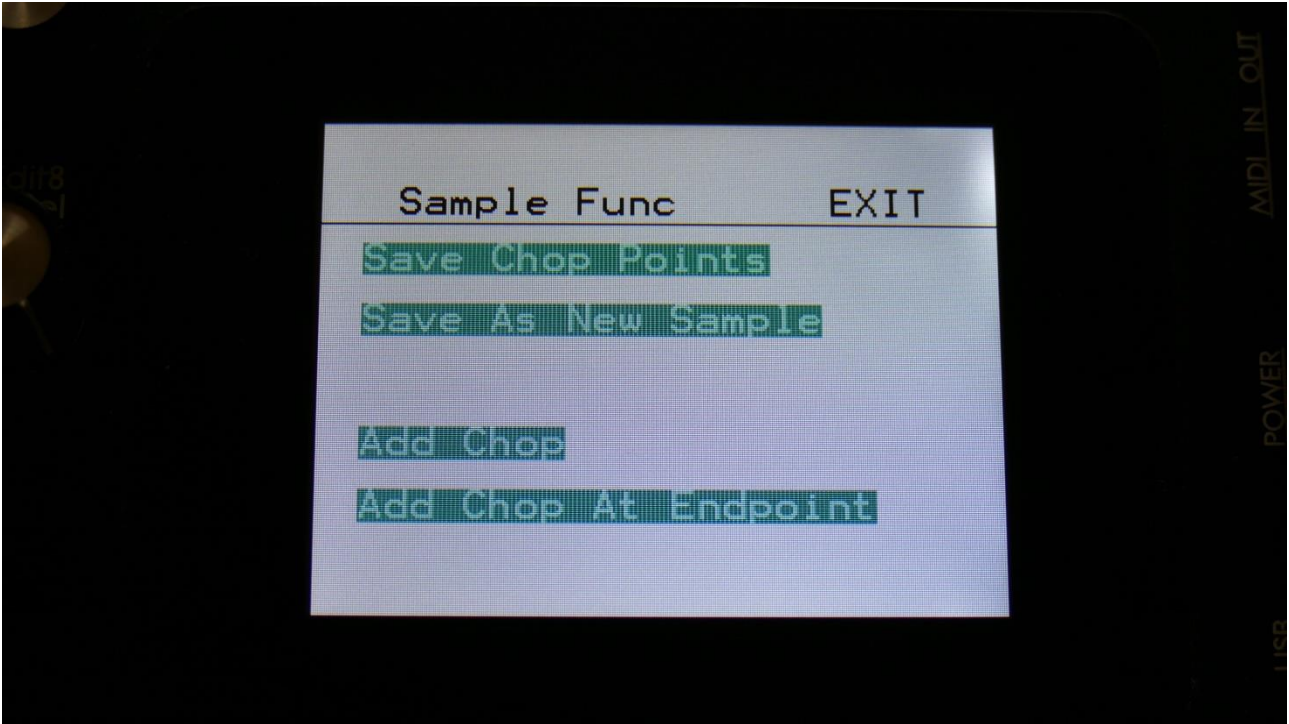

Touch “Save As New Sample”. A new page will now open. Select the sample bank, that you would like to copy the sampling/portion of the sampling to, by touching the A, B, C or D touch button.

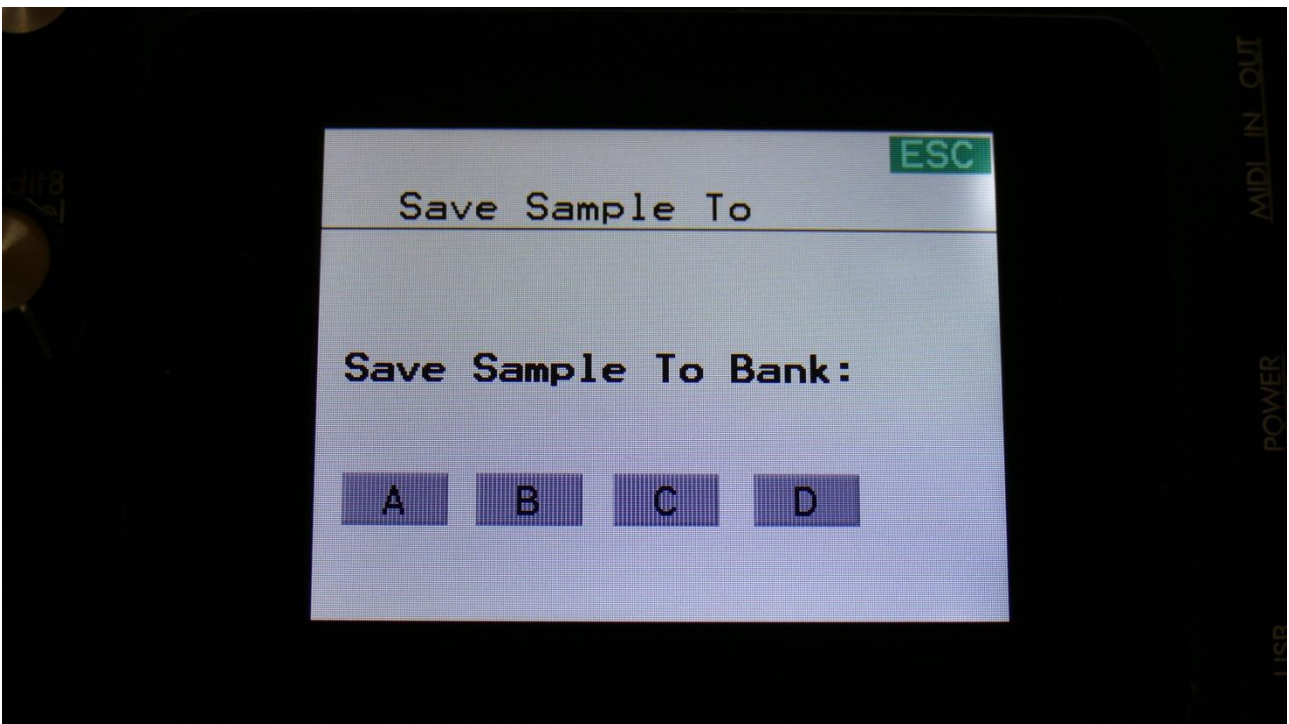

LD3 will write “Saving Sample...” for some time, and then it will jump back to the functions page.

WaveBuilder

The LD3 WaveBuilder lets you combine up to 8 samplings, to create a wave sequence from these. Whole samplings, parts of the samplings or chop points from the samplings, can be used to build a new wave sequence.

The wave sequence is saved as a new sampling, and a chop point is inserted, at the start point of each of the 8 waves, for easy selection of each partial, using the chop parameter.

WaveBuilder also lets you copy a sampling from one sample bank to another. Just select the sampling in WaveBuilder, set start to 0 and length to 511, and save it to the new bank.

The WaveBuilder always outputs to audio bus 1, so any filters and effects assigned to this bus, will affect the sound.

Enter WaveBuilder:

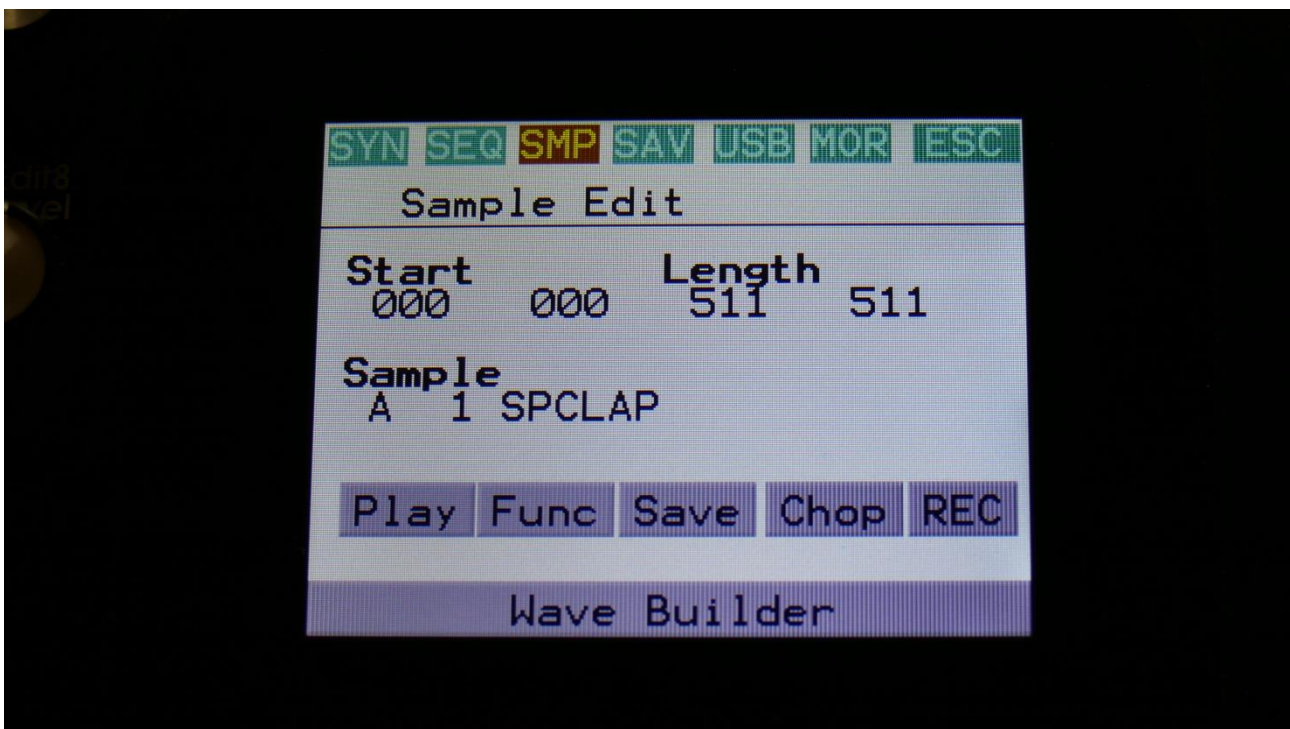

From the Sample Edit page, touch Wave Builder in the bottom of the page.

You will now enter this page:

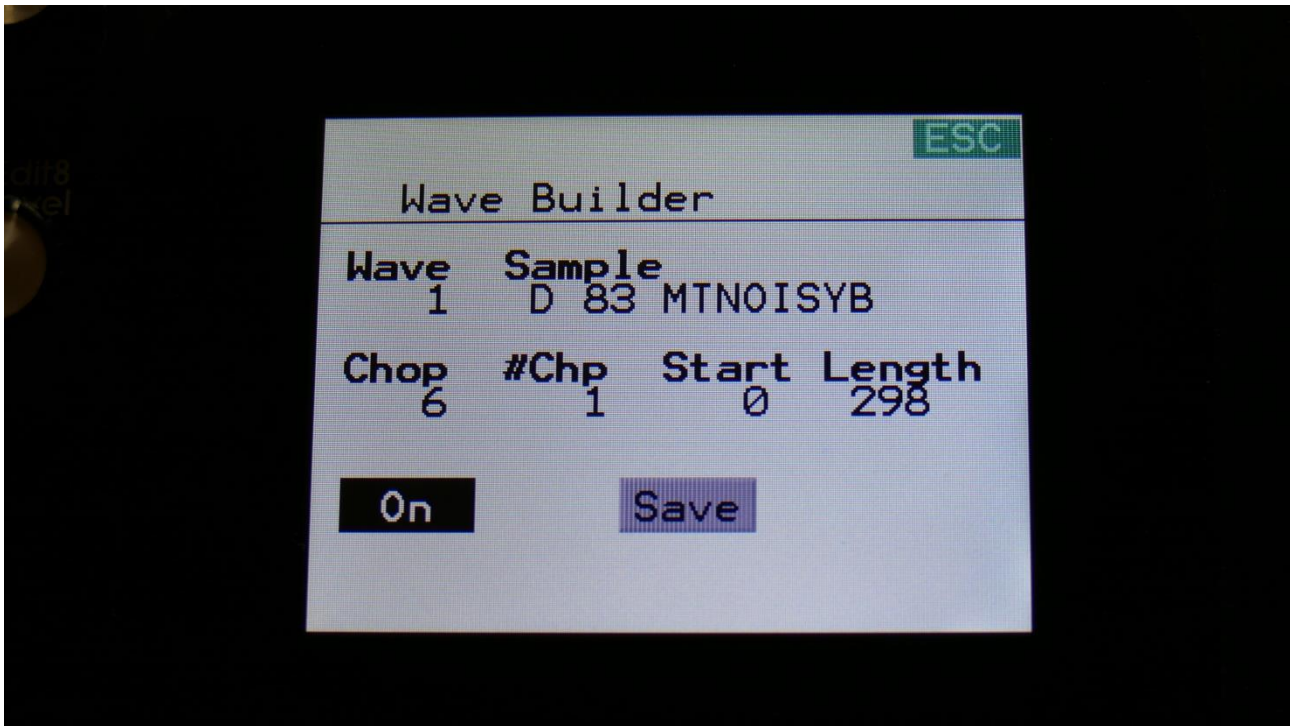

Wave: 1 to 8. Selects wave 1 to 8 of the wave sequence to be generated.

Sample: A0 to D2048. Selects the sampling for the selected wave. Edit knob 2 selects the sample bank (A to D), edit knob 3 selects the 100's in the sample number, and edit knob 4 select the 10's and the 1's in the number.

Chop: 1 to 64. Selects the chop point of the selected sampling, to be included in the wave sequence, if the selected sampling holds any chops.

#Chp: 1 to 64. Selects the number of chops to play back, from the selected chop.

Start: 0 to 511. Sets the start point of the sampling, of the range, that should be included in the wave sequence. If the selected sampling holds chop points, the start point will be inside the selected chop range.

Length: 0 to 511. Sets the length of the sample range, that should be included in the wave sequence. If the selected sampling holds chop points, the maximum length will be inside the selected chop range.

On/Off touch button: Each of the 8 waves can be separately switched on or off. As soon as at least one wave is on, WaveBuilder will start playing back the sequence of the waves. Any waves that are switched off, or has their length set to zero, will be skipped from the wave sequence.

Save touch button: As soon as you have selected samplings and chops, and adjusted the start and lengths, and you are satisfied with the result, you should touch this button, to save the new wave sequence.

This will get you to this page:

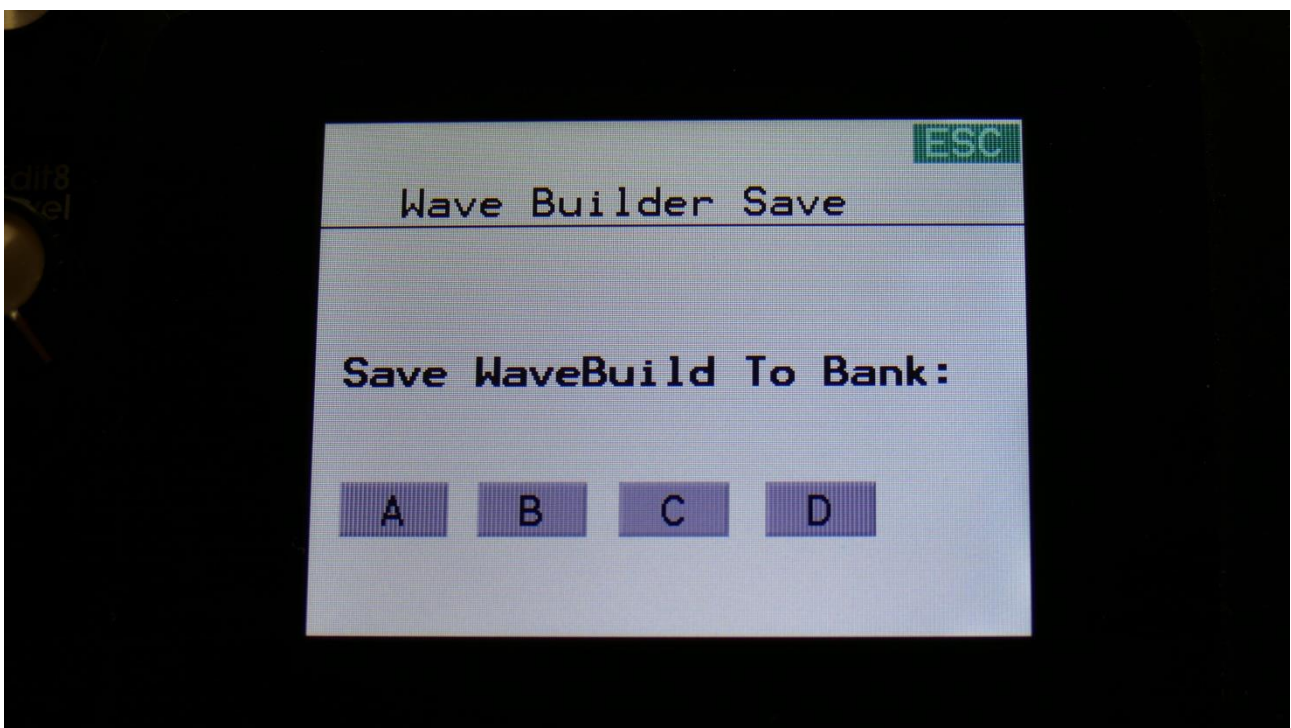

Now touch A, B, C or D, to save the wave sequence to the corresponding sample bank.

USB

The USB pages lets you access the files and directories of a USB drive, attached to LD3's USB connector.

You can import and export samples as .wav files, import and export presets and songs, update the Id3 firmware, and make new directories.

USB drives used with Id3 should be:

- Maximum 32 GB
- FAT formatted

From the Preset Select screen, touch the EDIT field, to enter the Main Synth page:

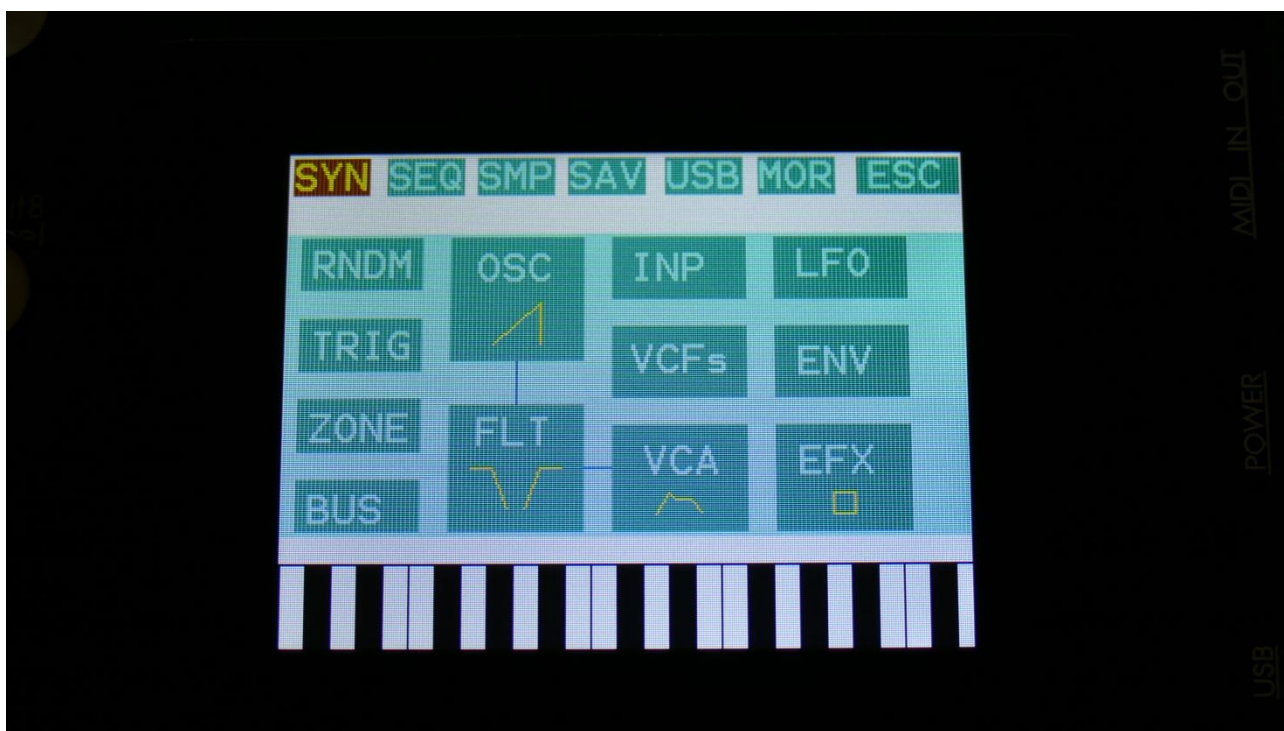

Touch USB on the navigation bar at the top of the screen.

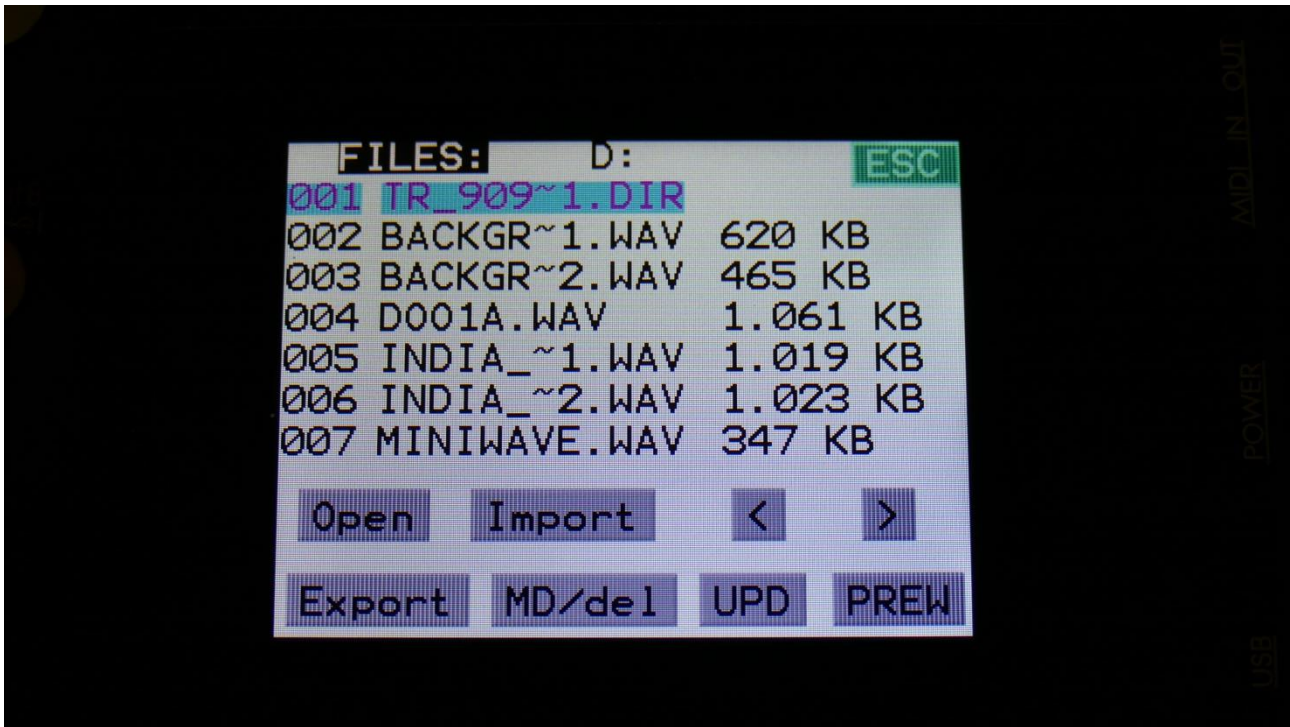

On this first page that you will enter, the root directory of the connected drive is shown. You can see that it is the root directory, by the "D:" in the top of the page. If you have accessed a directory, the name of this will replace "D:".

If you do not see the root directory of the drive, make sure that it is connected properly, and that it has the right specs, as described in the start of this section.

The names you see on the screen, are the names of the files and directories on the drive. File names are in black, and directory names are in purple. The currently selected file has a blue box around it. To select a file, simply touch it.

LD3 will show 7 files/directories at a time. By pushing the arrows, you can select the previous/next 7 files.

USB Sample Preview

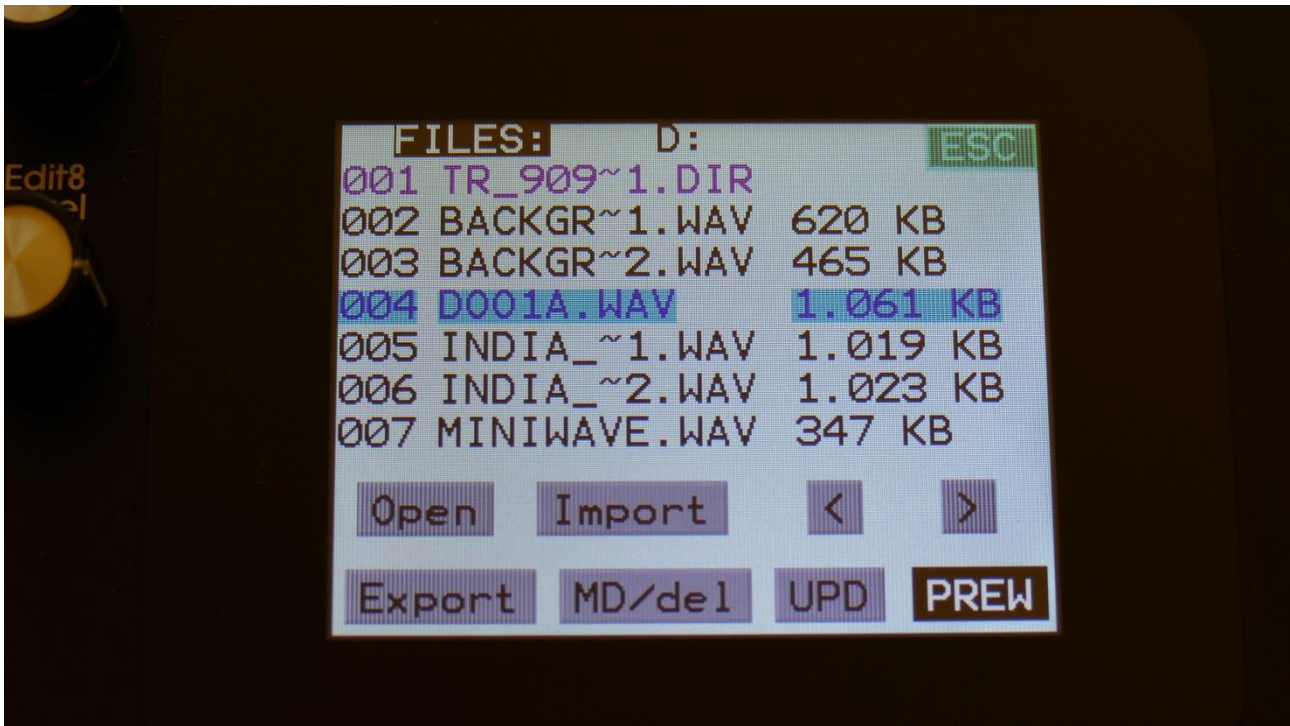

Wav samples can be previewed directly from a USB drive.

Select the sampling, that you would like to preview, by touching the sample name, and touch the PREW touch button. This will first show LOAD, then PREW again, while playing back the first 6 seconds of the sampling.

Open a directory (or folder)

To open a directory, to see what's inside, or to import single files or sub-directories, simply select the directory you would like to open, by touching it, and then touch the "Open" button.

LD3 will now open the directory, and show the first 7 files in it. The "D:" in the top of the screen, will now be replaced by the opened directory's name.

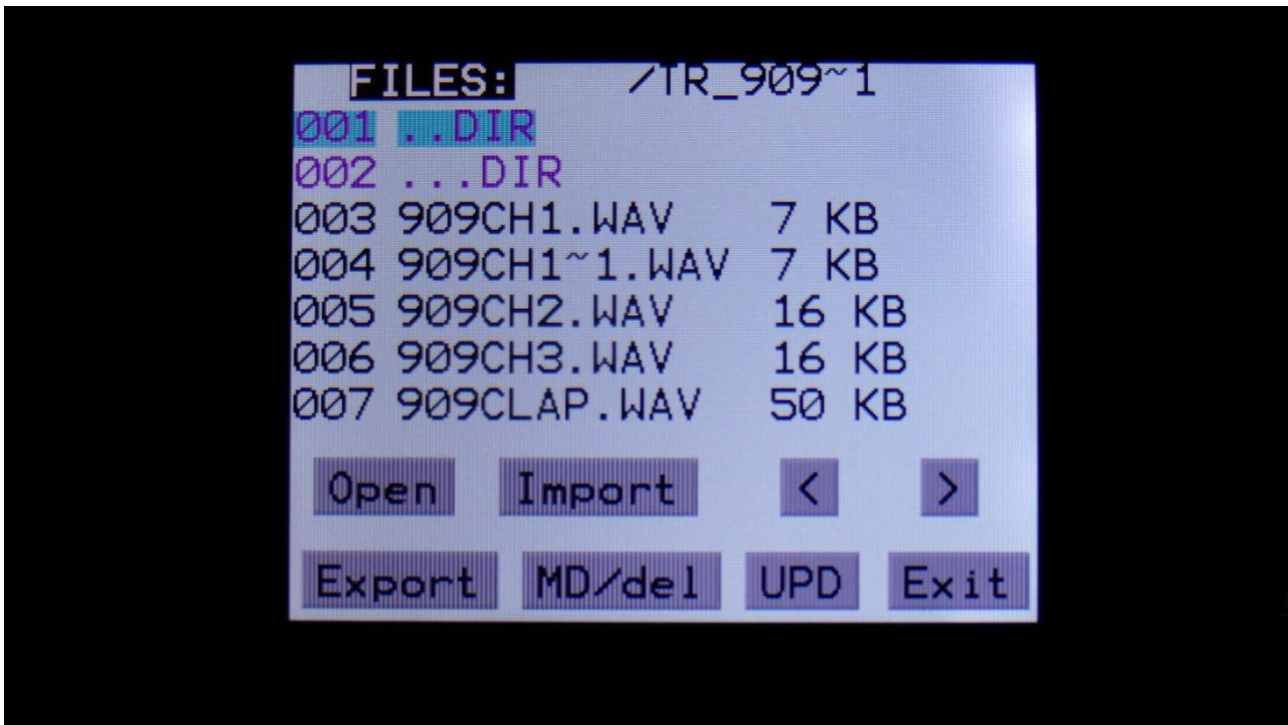

Importing files

Files that can be imported to LD3 are:

- Samplings with the ending .WAV, including LD3 generated chop points, and cue points generated by other gear/computer programs.
- Little deFormer samplings with the ending .LDS, including chop points.
- Presets with the ending .XDP
- Songs with the ending .XDO

Files that are shown, but can't be imported directly are:

- Update files with the ending .HEX

Files with any other ending will not be shown on LD3's screen, regardless of if they are present on the drive.

To import a single sampling or preset/song, select the .WAV/.LDS/.XDP/.XDO file you would like to import, by touching it.

Samples are imported to the sample bank selected on the Sample Edit page.

When importing a single preset or song, it is only loaded to the preset/song buffer, and you will have to save it manually, to keep it.

Touch the "Import" button. LD3 will now import the selected file, and show the progress on a progress bar:

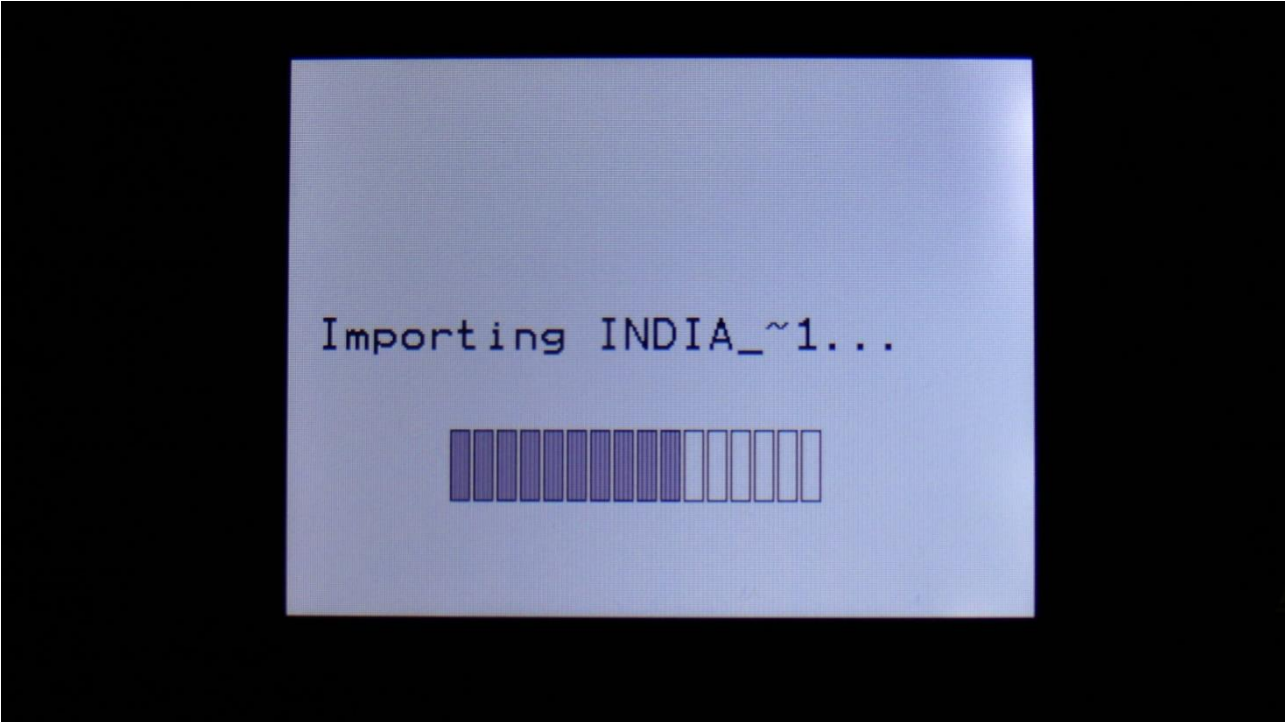

Importing multiple files

To import multiple files at one time, select a directory, by touching it. Touch the "Import" button. LD3 will now ask:

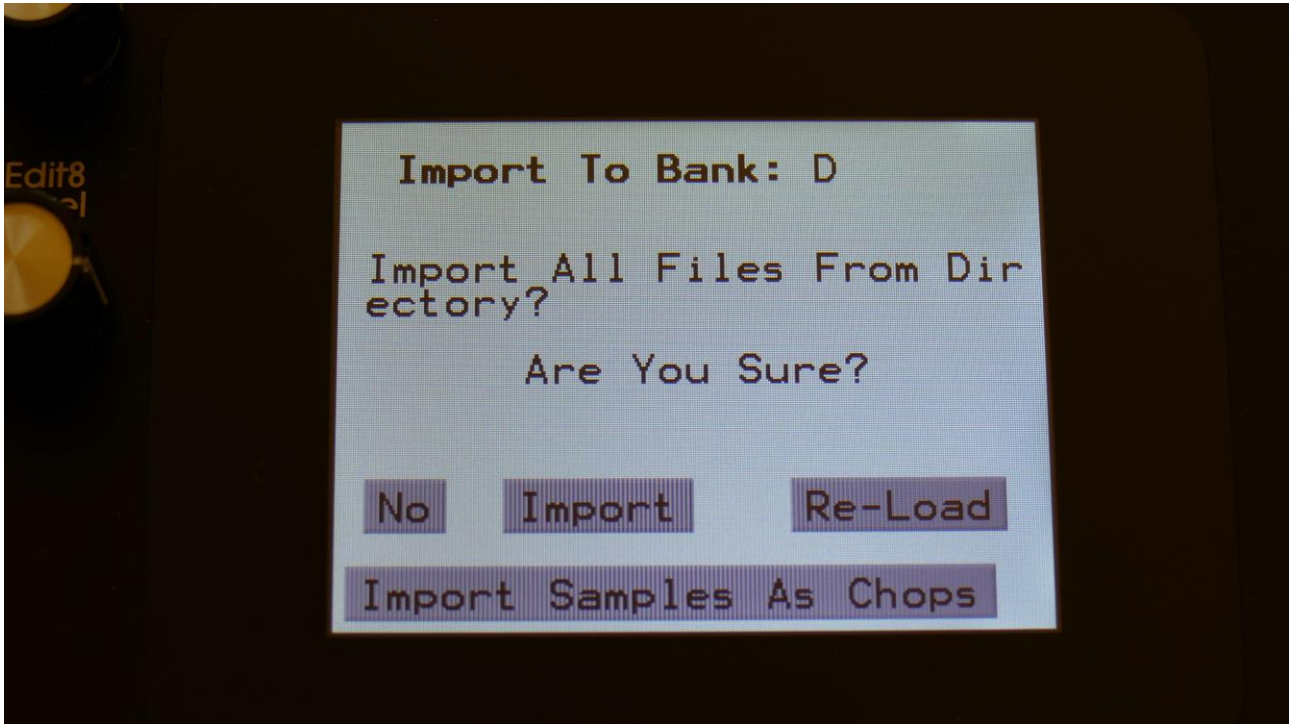

Touch "Import" to continue, or "No" to exit.

If you touched Import, LD3 will now import all samples, presets and songs, that the selected directory holds. It will though not import files from any sub-directories.

Samples are imported to the sample bank selected by Edit Knob 1, that is shown in the top of the screen. Presets are imported to the selected preset and forwards, so make sure that you have not selected a preset that you planned to keep, before using this function. Songs are also imported to the selected song and forwards, so make sure that you have not selected a song that you planned to keep, before using this function.

Reload multiple files

A reload function is also available. This will only import presets, songs and samples that has been exported from LD3, or that has been renamed to to fit the LD3 export standard –samples must be named: A0001.WAV, A0002.WAV.....A0220.WAV, B0001.WAV, B0002.WAV.....B0256.WAV, presets and songs must be named: A01.XDP, A02.XDP....A64.XDP, B01.XDP, B02.XDP.....P64.XDP .

This function will import presets and songs to the same locations as they were originally stored to.

Reload will also import samples to the exact same location, as they were placed when exporting. This will make sure, that samples used in your presets, will always be placed in the right locations. Sample locations that are already occupied, will be skipped by Reload, so make sure to erase sample bank A and B, if you want a complete reload.

To Reload multiple files, select a directory, by touching it. Touch the "Import" button. LD3 will now ask:

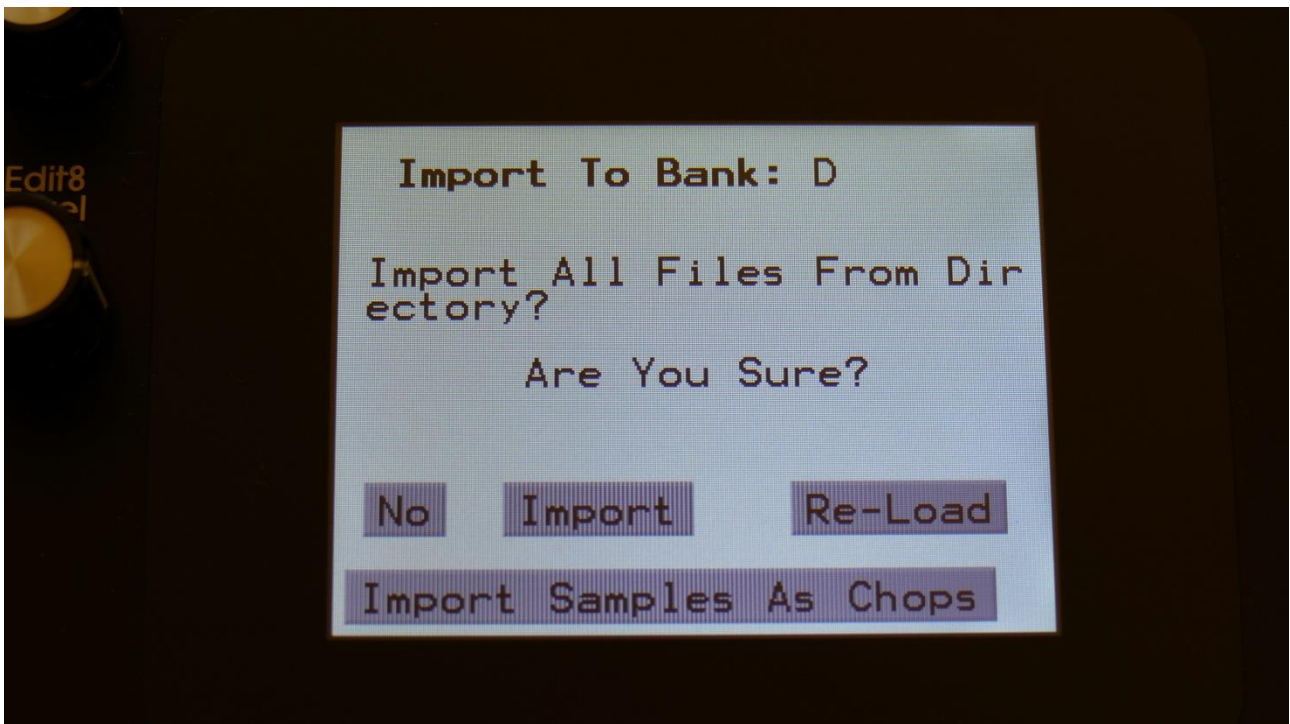

Touch "Re-Load" to continue, or "No" to exit.

If you touched Re-Load, LD3 will now import all samples, presets and songs, that the selected directory holds, and that are correctly named. It will though not import files from any sub-directories.

Reload does also have other functions:

-On LD3 itself, it is only possible to erase the last recorded sampling of bank A, B, C and D. By exporting all your samplings to a USB drive, and then delete sample bank A, B, C and D on LD3, delete the sample wav files you want to erase on the USB drive, from LD3 itself or on a computer, and reload all the samples. Samples that are erased, will just be left blank.

-If you would like to import a number of wav files in a specific order, or in a specific sample bank, you can rename the samples on a computer to: A0001.WAV, A0002.WAV.....A0220.WAV, B0001.WAV, B0002.WAV.....B0256.WAV, and then import them using Reload.

-If you would like to rearrange the order of samples and/or presets, you can rename the files and reload them. Presets are named: A01.XDP, A02.XDP....A64.XDP, B01.XDP, B02.XDP.....P64.XDP .

Import Multiple Samplings From Directory As one sampling with Chop points

This new function will make it easier than ever, to make your LD3 hold more than 8.192 samplings, in an easy way! Without splicing samples on a computer!

On your computer:

Make a directory (or folder) on an LD3 compatible USB drive. Name the directory with the name, that you want the sampling to have. Copy any single samplings you would like this sampling to contain, into the directory. Max 64 samplings.

Create multiple such directories, if desired.

Unmount the USB drive from your computer, and insert it in the LD3 USB port.

Enter the USB menu, select the directory you just created, and push “Import”.

This screen will now show:

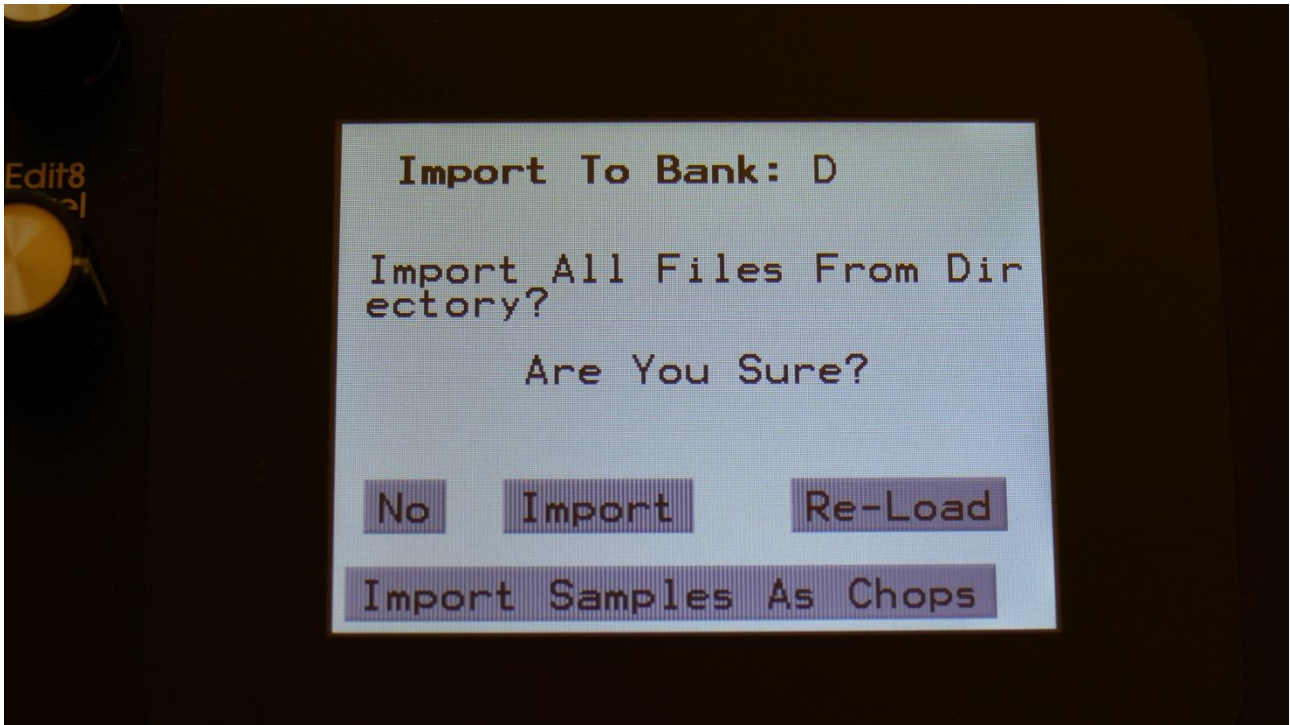

Touch “Import Samples As Chops”.

LD3 will now create one sampling from all of the samplings in the selected directory, and insert a chop point at the start point of each sampling.

Samples are imported to the sample bank selected by Edit Knob 1, that is shown in the top of the screen.

After the import is done, go to the sample edit page, select the sampling you just imported (named from the directory name), and enter the Chop edit page. You will now be able to hear each of the samplings, by selecting chops.

On the synth sampler pages, the procedure is the same. Select the sampling, and select the chop point. Modulate the chop point selection, to create great variation.

I have found this function especially useful, when working with acoustic drum samplings. There are many acoustic drum sample packs on the net, that has different variations of the same drum sound. Put all the variations of a sound in one directory, import as chops, and modulate the chop

selection with velocity, random or any other modulation source, to make some great dynamic acoustic drum beats.

Make a new directory

A new directory can be created in the root directory, or inside another directory.

To do this, touch the "MD/Del" button.



Turn the 8 edit knobs to select the 8 characters of the name for the new directory. When you are done with this, touch the "Make" button. The new directory will now be created.

You can, of course, also just touch "Exit", if you do not want to make a directory anyway.

Delete file from USB drive

It is possible to delete a file from the attached USB drive, directly from LD3.

To do this, select the file you would like to delete, and touch the "MD/Del" button.



Now touch the "Del" button.

Export samples, presets and songs to a USB drive

The samples, presets and songs held in LD3's FLASH memory can be exported to a USB drive, for back-up, or for use with other gear or computers. LD3 exports samples as standard 16 bit, 44.1 KHz, native PCM .wav files, so they can be used with any other gear, that supports this format. LD3 exports presets and songs in its own .xdp/.xdo format, so these can at writing moment only be used by LD3.

The factory sample bank can't be exported.

To enter the export page, touch the "Export" button:



All exports are done to the currently open directory. There are 4 different possibilities for exporting:

"1Prs"

Export 1 preset (song). Touching this button will export the currently selected preset. If LD3 are in song mode, it will export the selected song.

"AlPr"

Export All Presets/Songs . Touching this button will export all programmed presets. If LD3 are in song mode, it will export all programmed songs.

"1Smp"

Export 1 Sample. Touching this button will export the selected sample. Turn Edit Knob 1 to select the sample bank of the sample to be exported, and turn Edit Knob 2 to select the "100's" of the sample number, and Edit Knob 3 to select the 10's and 1's.

If you have selected any of the factory samplings, this will do nothing.

"AlSm"

Export All Samples. Touching this button will export all samples of the selected sample bank. The Sample Bank can be selected, by turning Edit Knob 1.

If the selected sample bank contains any factory samplings, these will not be exported.

Updating the LD3 firmware

Now and then updates will be available for LD3, that adds new functionality and fixes bugs. These will always be available for download at:

<http://www.gotharman.dk>

To update LD3, you must have a computer with an internet connection, and an LD3 compatible USB drive ready. See the start of this section, for which USB drives that are LD3 compatible.

Then you should follow these steps:

1. Download the update file of the latest update, from the LD3 Updates site, to your computer.
2. Connect the USB drive to your computer.
3. Make sure that the USB drive is FAT formatted.
4. Create a directory in the root directory of this USB drive, that is named "UPDATE".
If the USB drive already contains a directory called UPDATE, please delete all files inside this.
5. Copy the update file from your computer to the USB drive UPDATE directory. Make sure that no other files are present in this folder, and please don't rename the files.
6. Eject and remove the USB drive from your computer, and connect it to LD3 's USB connector.
7. Turn LD3 on, if it isn't already turned on.
8. From the preset select screen, touch the EDIT field.
9. Touch USB.
10. Wait for LD3 to register the USB drive, so all files and folders are presented on the screen.

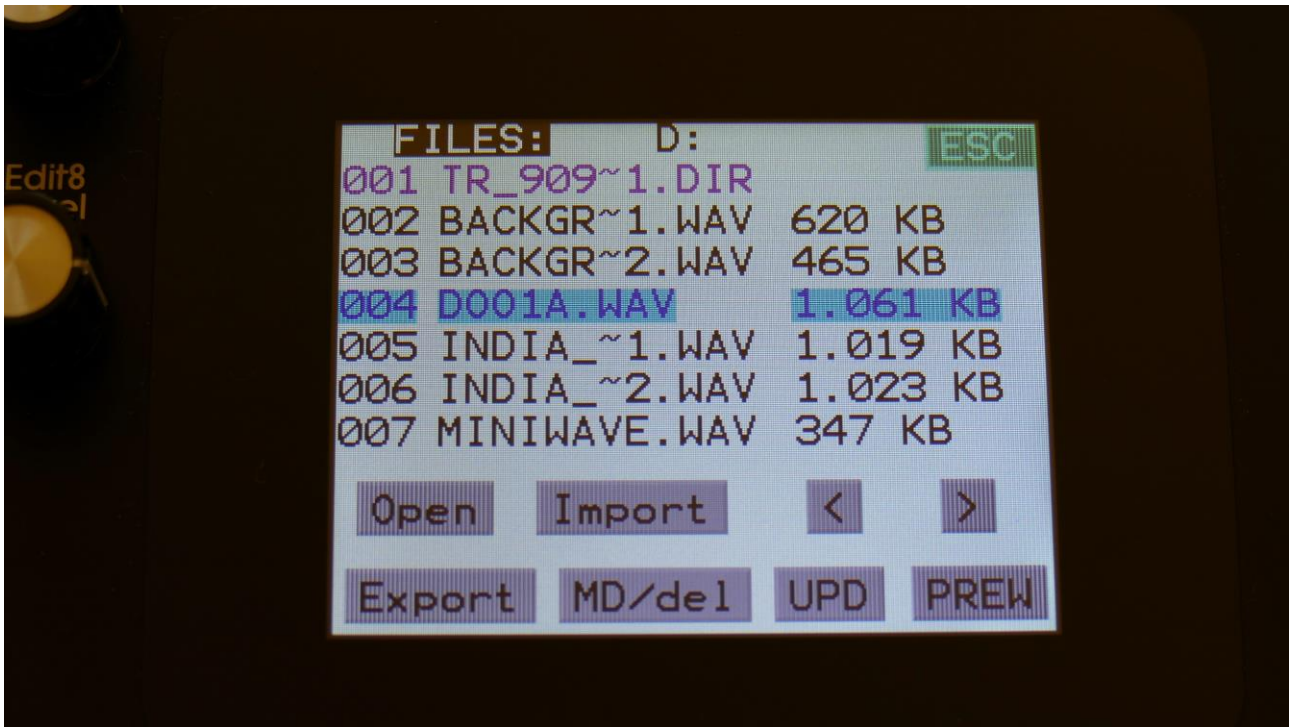

11. Touch the "UPD" button.

12. LD3 will now search for the "UPDATE" folder and a valid update file. If it finds both, it will ask: "Update Firmware?"

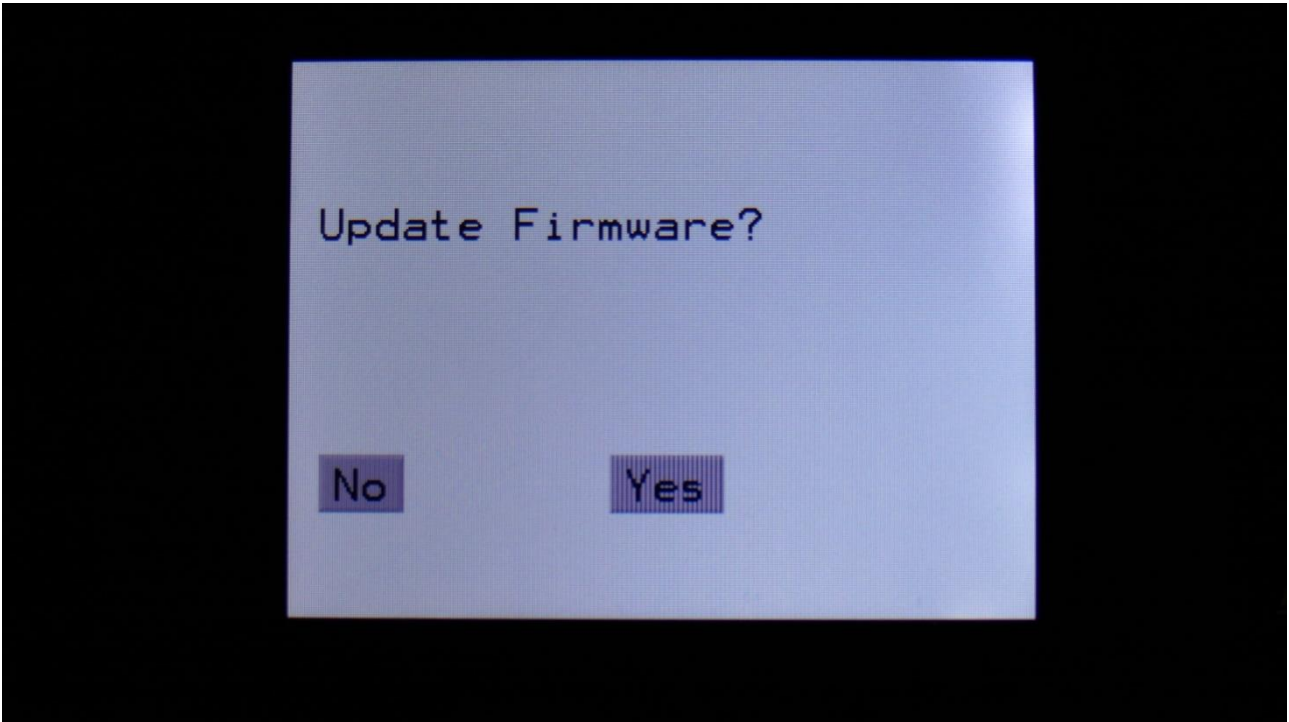

13. Touch "Yes" to proceed with updating, or "No" if you regret.

14. If you pushed Yes in step 13, LD3 will now start to get the update file, and program its processor.

When it starts to program the processor, it will look like it halts for a couple of minutes. This is because it does halt, when erasing the program memory of a processor.

Erasing the program memory of the processor:

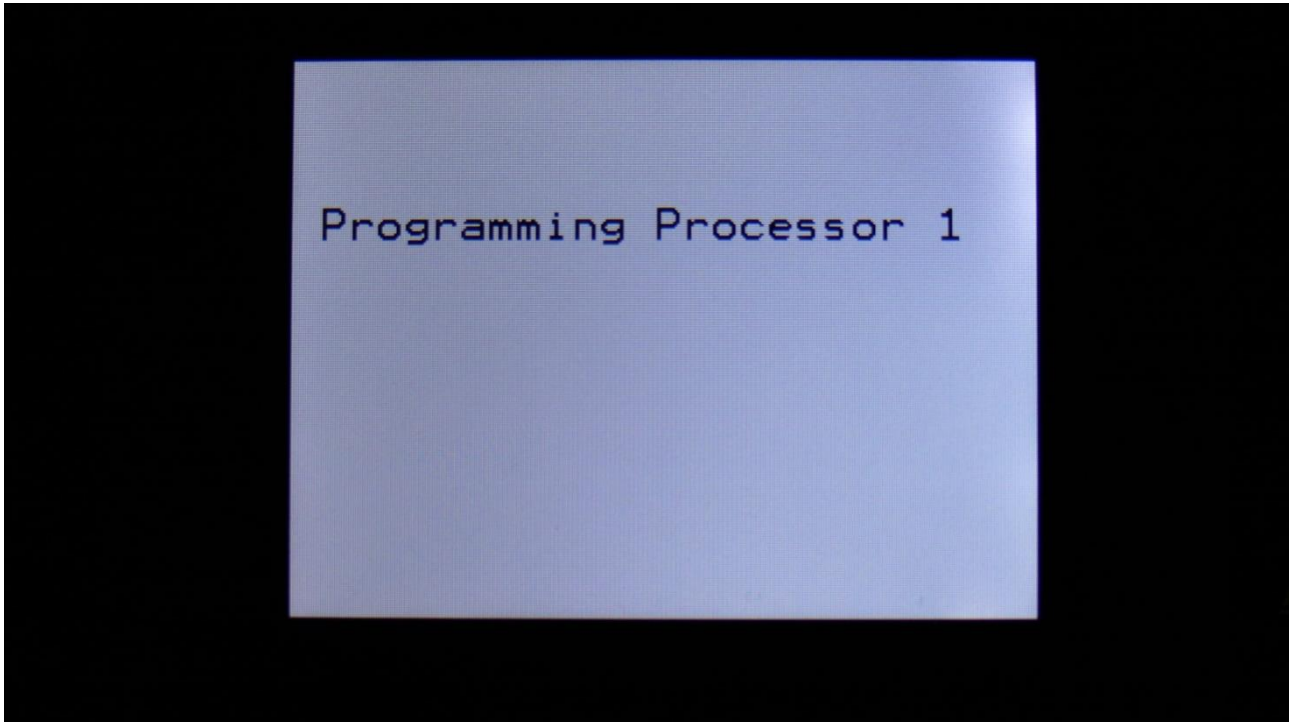

Programming processor (counter in the bottom counts up):

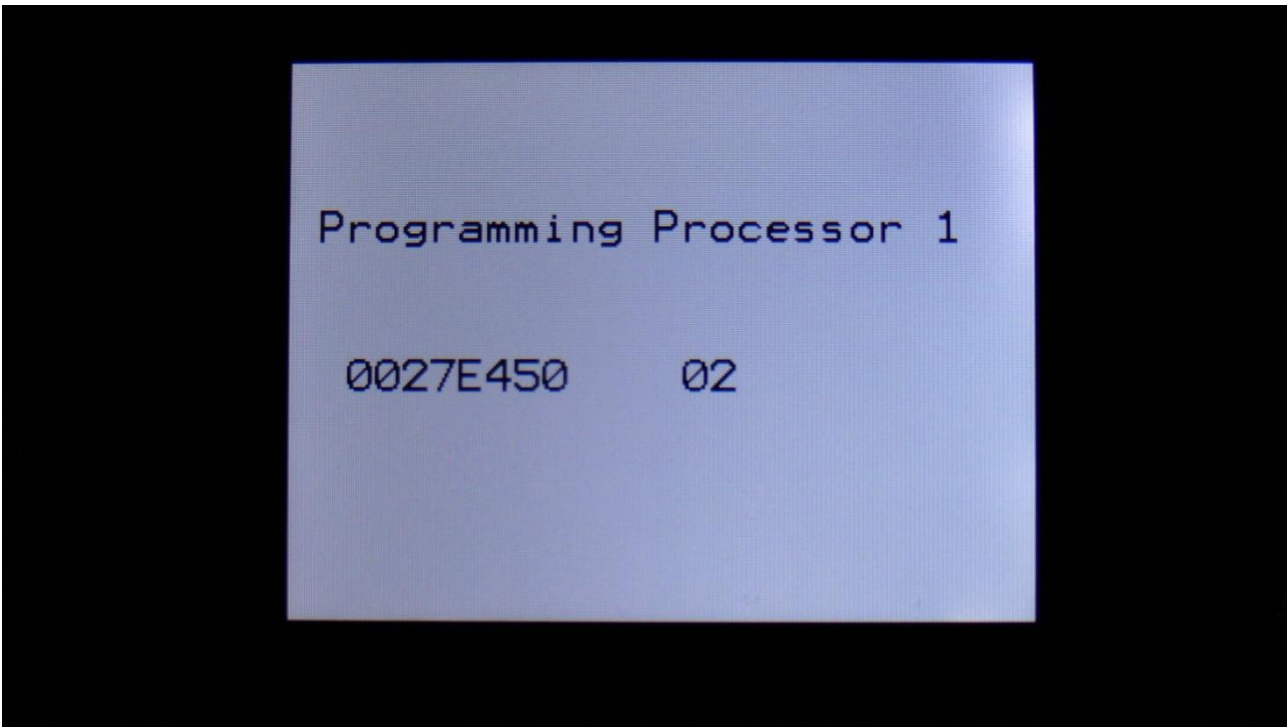

15. When programming is done, LD3 will ask you to restart it. Please turn LD3 off and then on again.

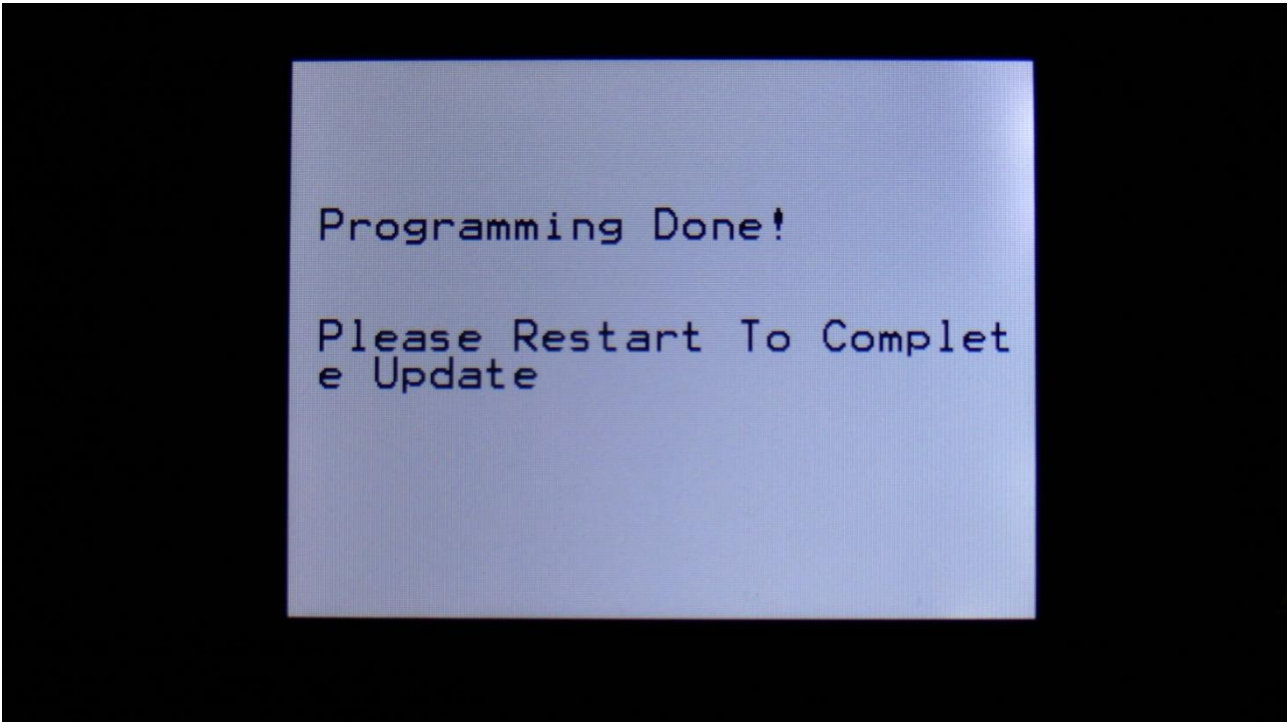

16. When you turn on LD3 after an update, it will need to finalize this. It will show this by turning 10 step button LED's on and off sequentially, one by one. After it has done this for a little while, it will start normally and are ready to use.

While it is finalizing the update, an initial text will show on the display:

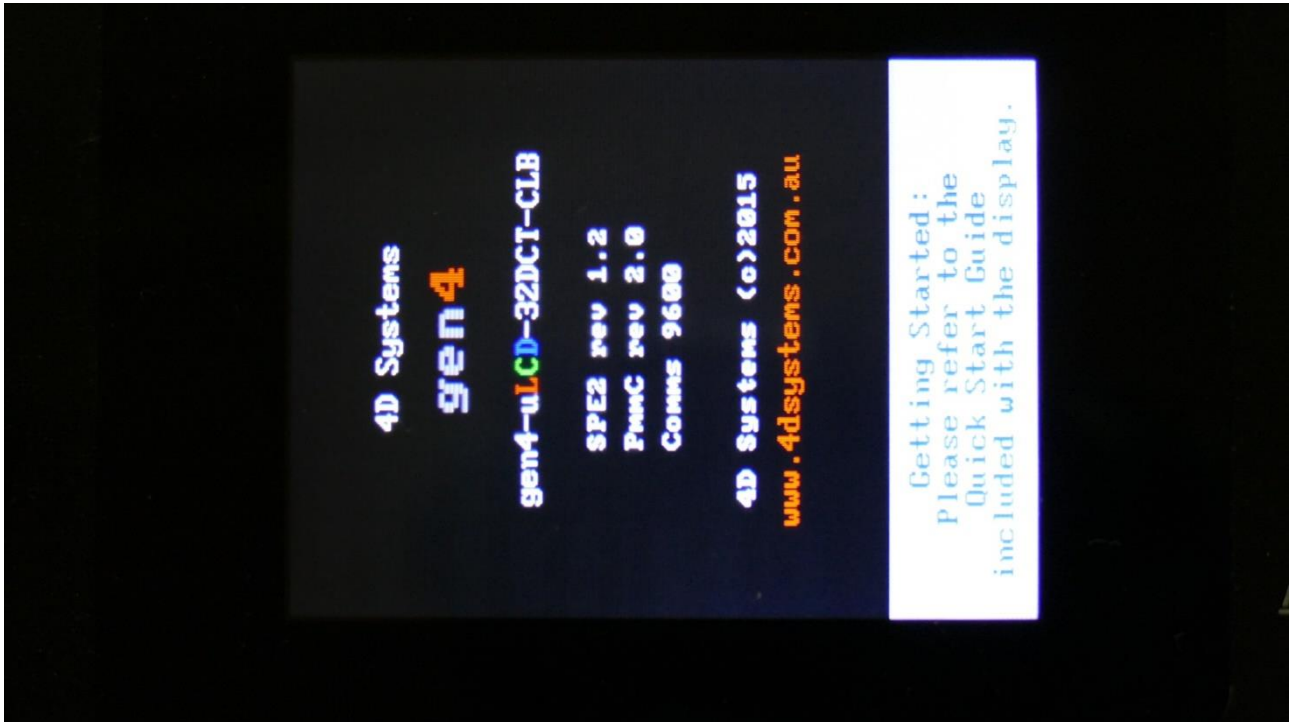

If something goes wrong:

-If the power should go off, while LD3 is getting the update from the USB drive, and programming the processors, simply start over again from step 7.

-If the power should go off, while LD3 is finalizing the update (3 LED's turn on and off), simply turn LD3 on again, and it will now finalize the update.

MIDI Specs

Receives:

-Note on/off's on the LD3 global MIDI channel and on the individual part MIDI channels in Multi-timbral mode. These can trigger the parts and be recorded by the sequencer, when it is in realtime rec mode.

-MIDI CC 1, 2, 4, 5, 7, 8, 9, 10, 11 and 12 on the LD3 global MIDI channel and on the individual part MIDI channels in Multi-timbral mode. All parameters that are set up to be controlled by Edit Knob 1 to 8, are also controlled by these MIDI CC's.

Morph Knob: CC1

Seq Morph Knob: CC2

Edit Knob 1: CC4

Edit Knob 2: CC5

Edit Knob 3: CC8

Edit Knob 4: CC9

Edit Knob 5: CC10

Edit Knob 6: CC11

Edit Knob 7: CC12

Edit Knob 8: CC7

CC16, touch screen keyboard Y-position on the part zone midi channel, regardless of, if LD3 are in multi-timbral mode or not.

MIDI CC's 17 to 61 as modulation sources.

MIDI CC 64, MIDI Sustain Pedal. Values above 64: Hold notes, values below 64: Release notes.

-Pitch Bend messages on the LD3 global MIDI channel and on the individual part MIDI channels in Multi-timbral mode. Controls the oscillators and samplers of part 1 to 16, and any parameter that has pbend set as its modulation source.

-MIDI clock and start/stop messages are received if the sequencer are in external sync mode.

-Program change and bank change (MIDI CC 32), if Prgr is switched on at the Common page.

Accepted bank changes:

0: Preset bank A and B.

1: Preset bank C and D.

2: Preset bank E and F.

3: Preset bank G and H.

4: Preset bank I and J.

5: Preset bank K and L.

6: Preset bank M and N.

7: Preset bank O and P.

Any other bank change messages will be ignored

Transmits:

- MIDI CC 1, 2, 4, 5, 7, 8, 9, 10, 11 and 12 on the LD3 global MIDI channel, or on the part MIDI channel, from the knobs on the Preset/Song Select screen, and on any other pages, that has no other Edit Knob functions.

CC16, touch screen keyboard Y-position on the global midi channel.

-Note on/off's on any MIDI channels from the sequencer/part system.

-MIDI CC's on any MIDI channel from the sequencer controller tracks.

Parameters CC control

Many of the LD3 parameters can be hard-assigned to MIDI CC's, for direct control from an external MIDI controller. The same parameters can also be controlled directly from the sequencer controller tracks, and movements of these can be realtime recorded to the controller tracks.

For part parameters, MIDI channel are equal to part number.

To activate the CC control, first enter the MOR>COMMON page:

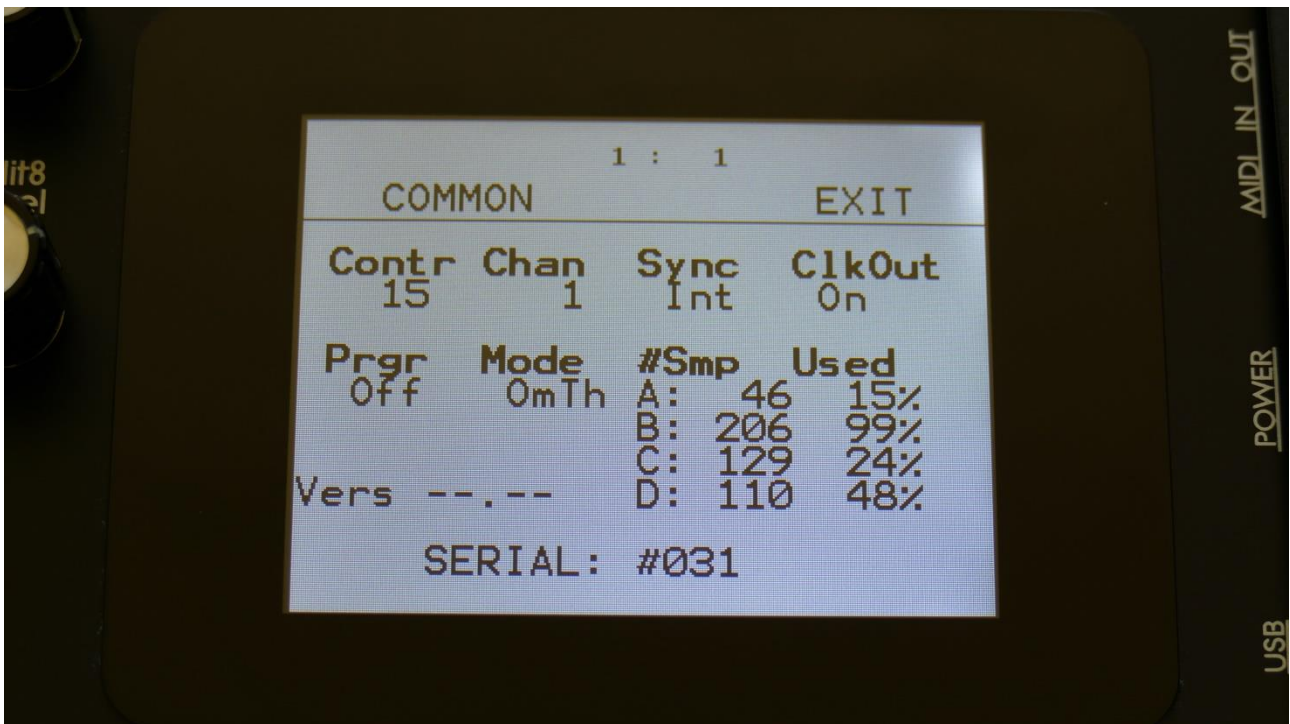

Here you must set the Mode parameter (MIDI In Mode) to either Omni, OmTh (Omni Thru), Mult (Multi-Timbral) or MuTh (Multi-Timbral/Thru). The CC control will not work properly in Sel (Selected) mode.

Then exit from the COMMON page, and enter the COM2 page:

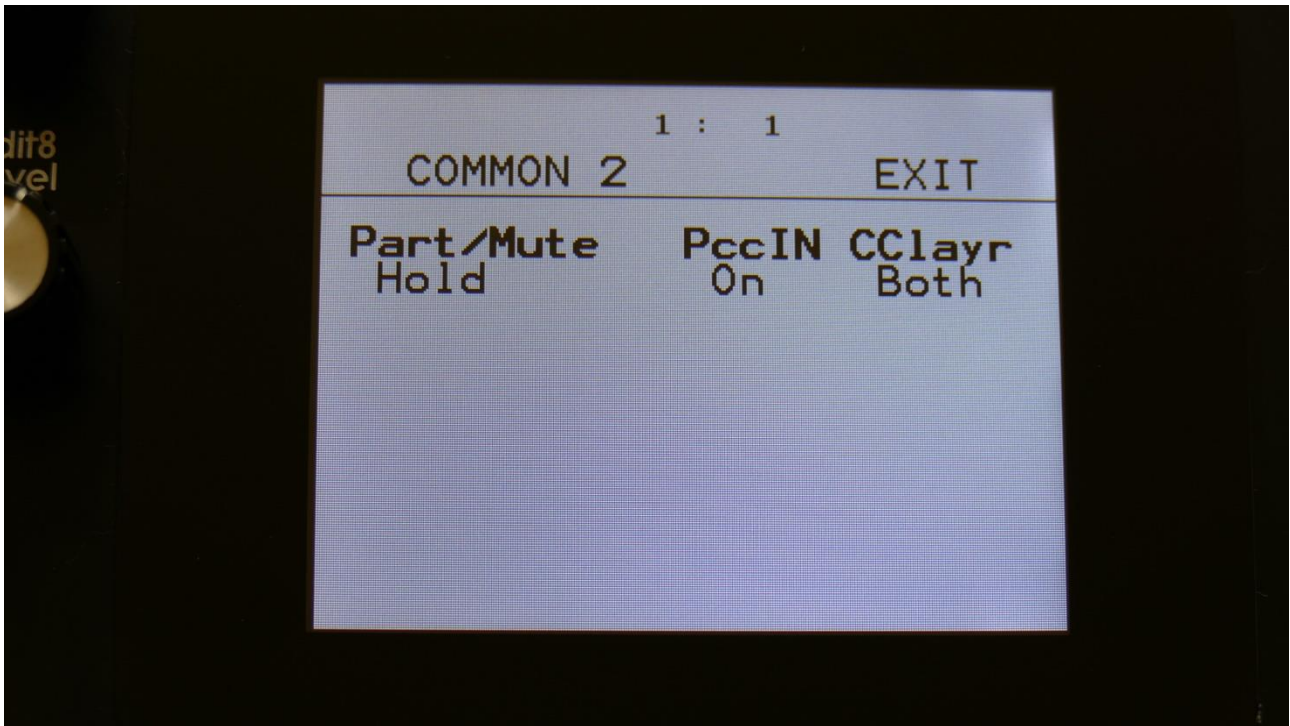

On this page, switch the **PccIN** parameter (Parameter CC Input) to On.

Set the **CClayr** parameter to Sel, if you would only like to control the selected Morph layer, or to Both, if you would like to control both Morph layers A and B at the same time.

Now you will be able to control many of the Spazeboard6 parameters from an external MIDI device, and from the Sequencer Controller Tracks.

On the following pages, you will find a list of the controllable parameters.

PARAMETER	CC#	PART NUMBER
Oscillator/Sampler Tune	17	MIDI channel 1-16
Oscillator/Sampler Fine Tune	18	MIDI channel 1-16
Oscillator Wave/Sampler Start	19	MIDI channel 1-16
Oscillator PW/Sampler Length	20	MIDI channel 1-16
Oscillator/Sampler FM	21	MIDI channel 1-16
Oscillator/Sampler Porta	22	MIDI channel 1-16
Sampler Chop Select	23	MIDI channel 1-16
Digi Filter 1 Cut	24	MIDI channel 1-16
Digi Filter 1 Reso	25	MIDI channel 1-16
Digi Filter 1 Input Level	26	MIDI channel 1-16
Digi Filter 1 Mix	27	MIDI channel 1-16
Digi Filter 1 Type	28	MIDI channel 1-16
Digi Filter 1 Narrow	29	MIDI channel 1-16
Digi Filter 1 Low	30	MIDI channel 1-16
Digi Filter 1 Boost	31	MIDI channel 1-16
Digi Filter 2 Cut	33	MIDI channel 1-16
Digi Filter 2 Reso	34	MIDI channel 1-16
Digi Filter 2 Input Level	35	MIDI channel 1-16
Digi Filter 2 Type	36	MIDI channel 1-16
Digi Filter 2 Mix	37	MIDI channel 1-16
Digi Filter 2 Narrow	38	MIDI channel 1-16
Digi Filter 2 Low	39	MIDI channel 1-16
Digi Filter 2 Boost	40	MIDI channel 1-16
VCA A	41	MIDI channel 1-16
VCA D	42	MIDI channel 1-16
VCA S	43	MIDI channel 1-16
VCA R	44	MIDI channel 1-16
VCA Drone	45	MIDI channel 1-16
VCA Output Level	46	MIDI channel 1-16
ENV1 A	47	MIDI channel 1-16
ENV1 D	48	MIDI channel 1-16
ENV1 S	49	MIDI channel 1-16
ENV1 R	50	MIDI channel 1-16
ENV2 D	51	MIDI channel 1-16
LFO Rate	52	MIDI channel 1-16
LFO Wave	53	MIDI channel 1-16

PARAMETER	CC#	PART NUMBER
VCF1 Cut/HpCut	54	-
VCF1 Peaks/LpCut	55	-
VCF1 Reso	56	-
VCF1 Feed/Hpf Cut/Spaze	57	-
VCF1 Out ½	58	-
VCF1 Input Level	59	-
VCF1 Output Level	60	-
VCF1 FM	61	-
VCF1 G-RAY Feed	62	-
VCF2 Cut/HpCut	63	-
VCF2 Peaks/LpCut	65	-
VCF2 Reso	66	-
VCF2 Feed/Hpf Cut/Spaze	67	-
VCF2 Out ½	68	-
VCF2 Input Level	69	-
VCF2 Output Level	70	-
VCF2 FM	71	-
VCF2 G-RAY Feed	72	-
VCF3 Cut/HpCut	73	-
VCF3 Peaks/LpCut	74	-
VCF3 Reso	75	-
VCF3 Feed/Hpf Cut/Spaze	76	-
VCF3 Out ½	77	-
VCF3 Input Level	78	-
VCF3 Output Level	79	-
VCF3 FM	80	-
VCF3 G-RAY Feed	81	-
VCF4 HpCut	82	-
VCF4 LpCut	83	-
VCF4 Reso	84	-
VCF4 Spaze	85	-
VCF4 Input Level	87	-
VCF4 Output Level	88	-
VCF4 FM	89	-
VCF4 G-RAY Feed	90	-

PARAMETER	CC#	PART NUMBER
Insert EFX 1 Mix	91	-
Insert EFX 1 Parameter 1	92	-
Insert EFX 1 Parameter 2	93	-
Insert EFX 2 Mix	94	-
Insert EFX 2 Parameter 1	95	-
Insert EFX 2 Parameter 2	96	-
Insert EFX 3 Mix	97	-
Insert EFX 3 Parameter 1	98	-
Insert EFX 3 Parameter 2	99	-
Insert EFX 4 Mix	100	-
Insert EFX 4 Parameter 1	101	-
Insert EFX 4 Parameter 2	102	-
Insert EFX 5 Mix	103	-
Insert EFX 5 Parameter 1	104	-
Insert EFX 5 Parameter 2	105	-
Insert EFX 6 Mix	106	-
Insert EFX 6 Parameter 1	107	-
Insert EFX 6 Parameter 2	108	-
Insert EFX 7 Mix	109	-
Insert EFX 7 Parameter 1	110	-
Insert EFX 7 Parameter 2	111	-
Insert EFX 8 Mix	112	-
Insert EFX 8 Parameter 1	113	-
Insert EFX 8 Parameter 2	114	-
Output EFX 1 Mix	115	-
Output EFX 1 Parameter 1	116	-
Output EFX 1 Parameter 2	117	-
Output EFX 2 Mix	118	-
Output EFX 2 Parameter 1	119	-
Output EFX 2 Parameter 2	120	-

Effects Parameters 1 and 2

The effects parameters 1 and 2, are the 2 parameters located to the right of the Mix parameter, on the effects main pages:

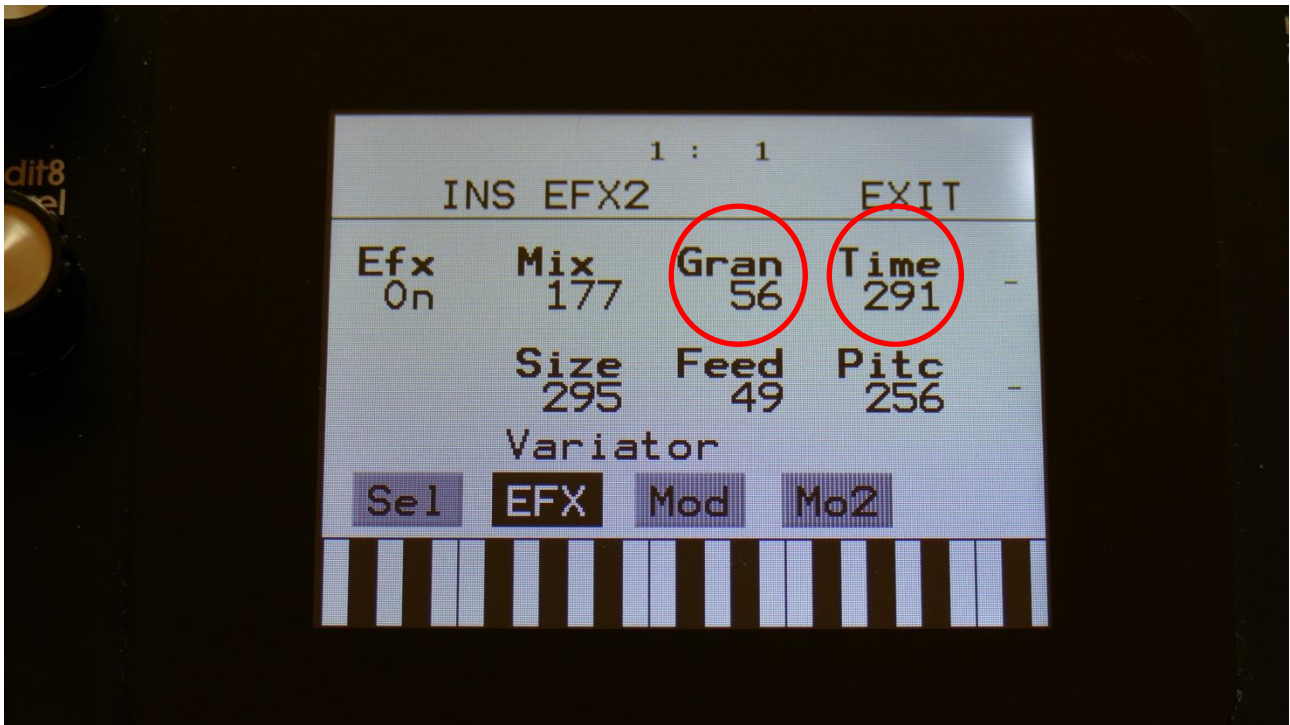

Controlling the CC parameters from the Sequencer Controller Tracks

Enter a sequencer controller track, and go to the CC sub page:

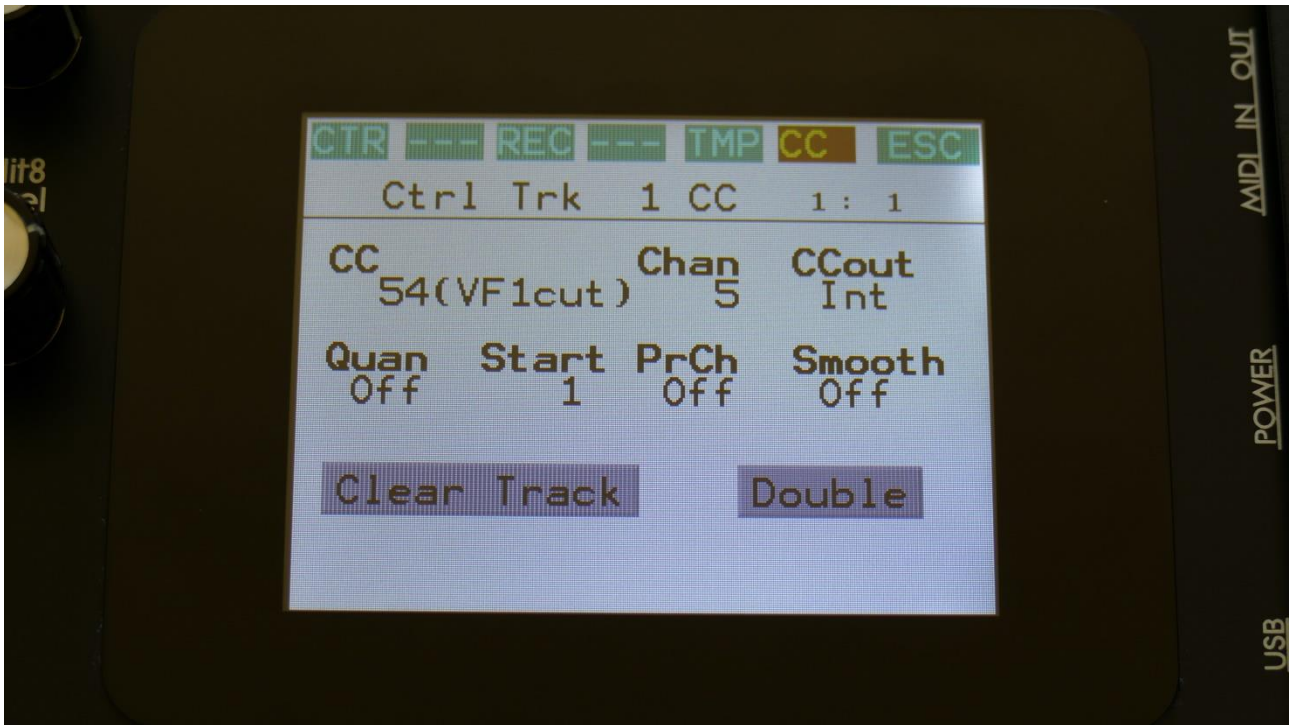

Set the CC parameter, to the parameter, that you want to control with the controller track. A shorted version of the parameter name, will be written in parenthesis.

Then set the Chan parameter to the part number, that you would like to control, if it is a part related parameter.

At last, set the CCout to internal.

It is **important** to set the parameters up, using this sequence. If you set the CCout parameter to internal first, and then set the CC parameter, all the parameters that you pass, will be affected by the controller track.

Now go to the CTR page, and control the parameter.

Safe Boot Mode



If your LD3 should ever refuse to start up, you should do this:

- Hold down trigger button 1, while turning your LD3 on.
- Keep it pressed, until the main (preset select) screen appears.
- This will now look a bit different, as shown on the picture.
- In safe mode all audio are disabled. It is possible to switch preset and to update your LD3.
- Switch to the preset below the currently selected one. Turn your LD3 off and on again, and see if it now boots up.
- If this does help: Please boot up in safe mode again, select the preset that caused the problem, export this to a USB drive, zip it, and send it via an email to info@gotharman.dk. Then I will inspect it.
- If this doesn't help: Get in touch with Gotharman's!

Installing/exchanging Analog FilterBoards

This chapter will describe how to install or exchange analog filterboards.

PLEASE NOTICE: It is only possible to install/exchange filterboards, when the **Analog Board** are installed in your LD3. This is NOT possible, with **SPACEboard2** installed!

You will need the following tools:

- A Phillips screwdriver
- A 2.5mm Allen screwdriver



Before you open your LD3, insert the power supply in a wall socket, and touch the metal on the connector. This will unload you from any static electricity, that might damage the electronics.

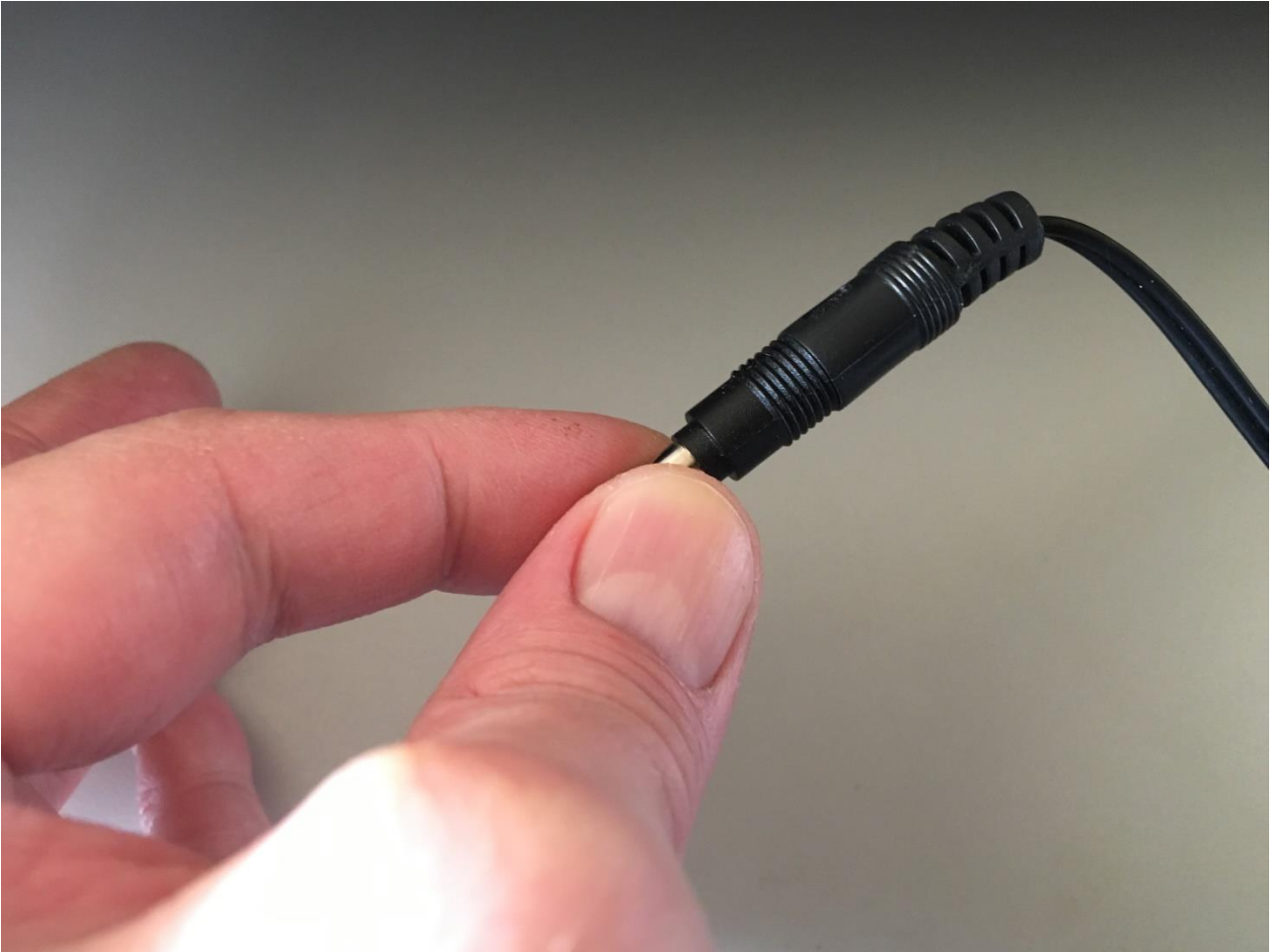

Remove the 4 screws in the corners of the left end panel, using the Phillips screwdriver.



Take the left end panel a bit out.

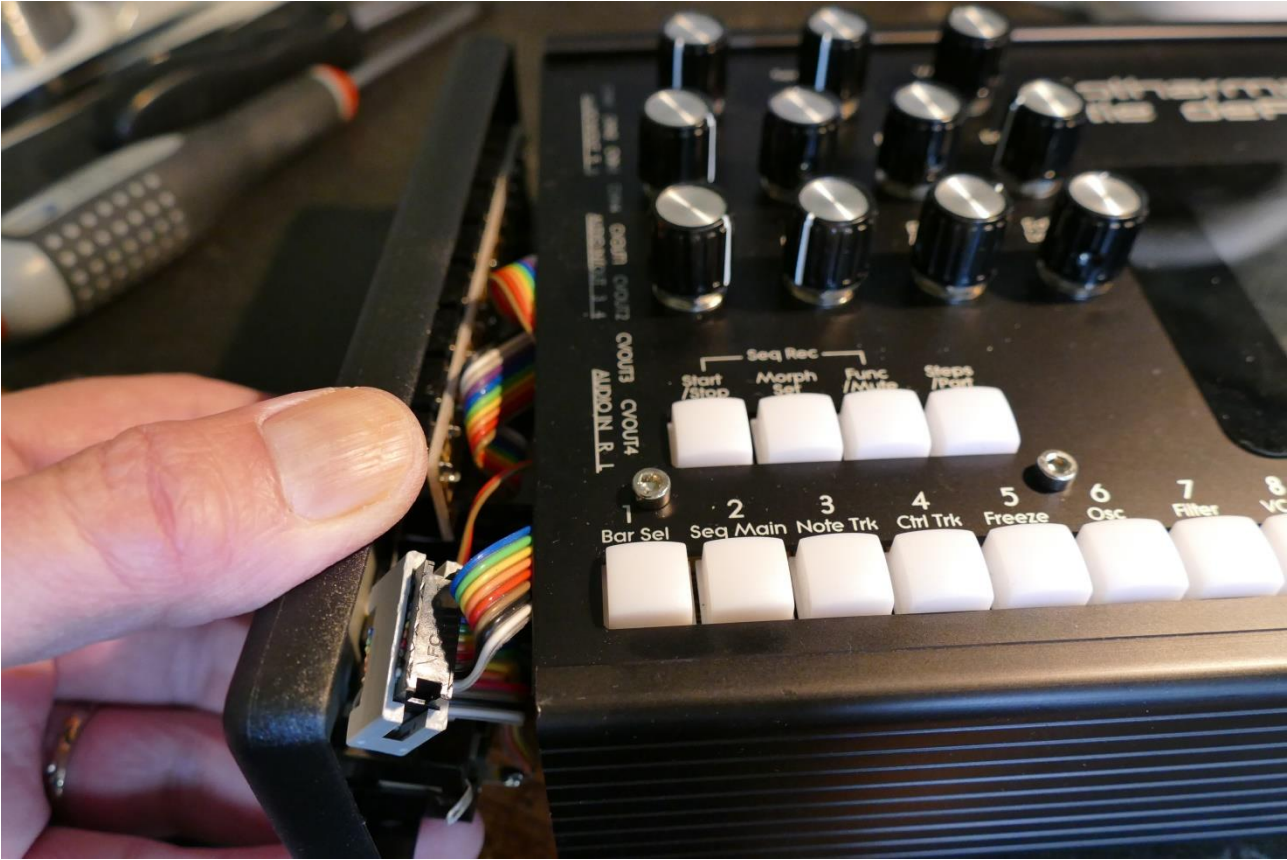

Turn your LD3 around, and remove the 4 screws in the corners of the right end panel, again using the Phillips screwdriver.



Take the right end panel a bit out.



Remove the plastic frame from the left end panel.

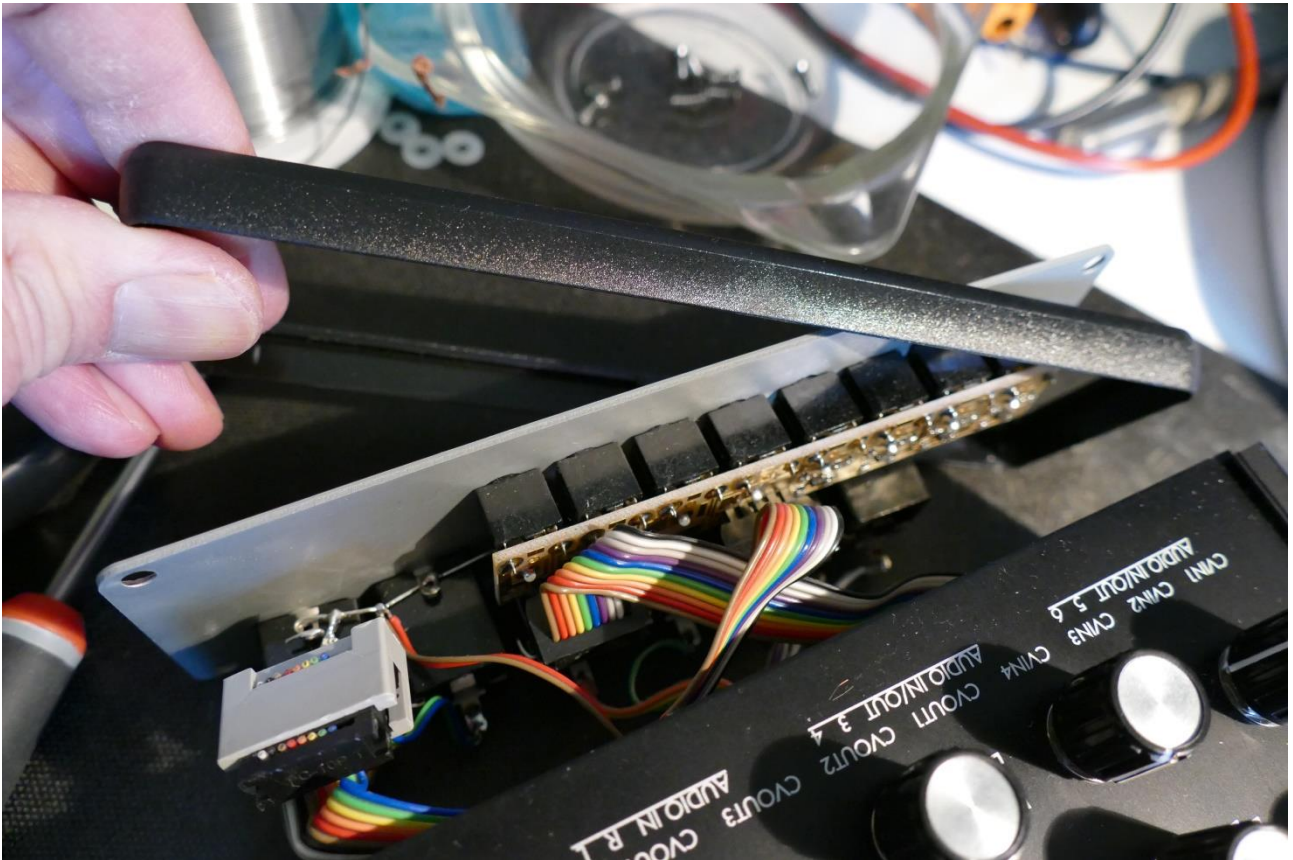

Now carefully slide the front panel towards the right, while navigating the left end panel, to stay inside the box, in order not to scratch the top of the box.



Slide the front panel all the way to the right, so that it is free of the box.

Put the box somewhere else, so you have the front panel and the two end panels for themselves.



Flip LD3 around, so that the front panel is facing downwards.

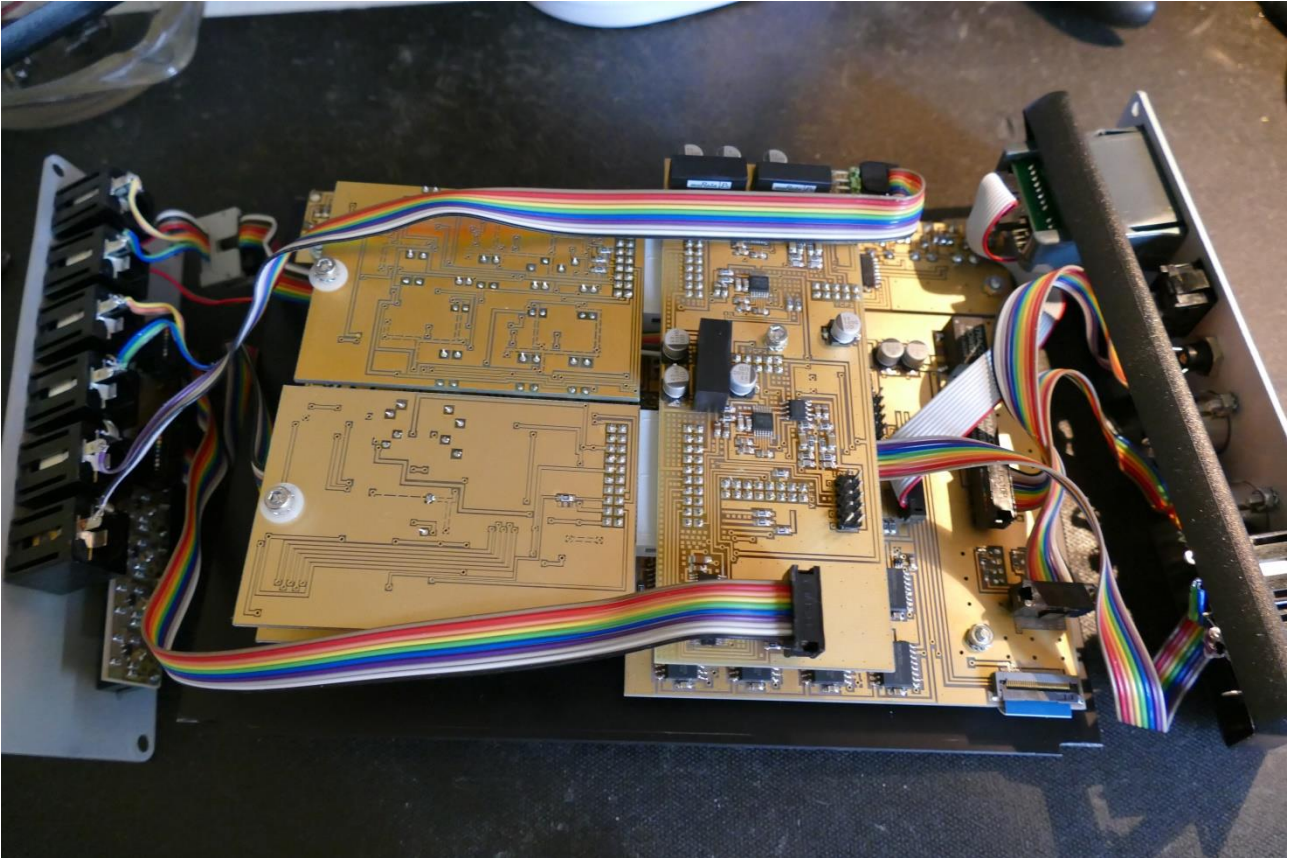

If your LD3 already has filterboards installed, you will now see the two filterboards attached to the analog board.

Remove the screw holding the filterboard in place, on one or both of the filterboards, using the 2.5mm Allen screwdriver.

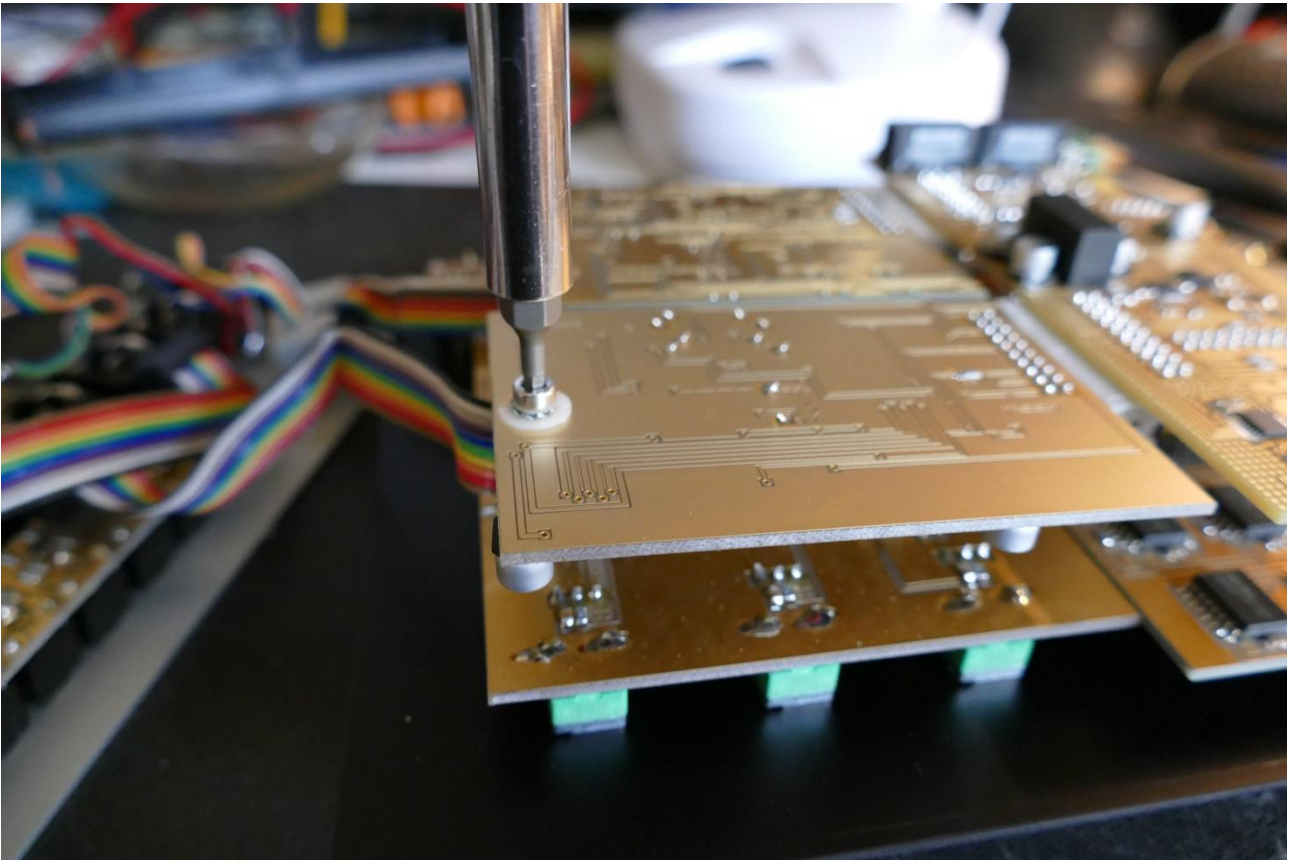

If your LD3 does not yet have any filterboards installed, just remove the screw and the 3 washers.

Take care of not losing the screw and the washers.

Hold the filterboard on the sides as shown. Holding only on the sides of it, will minimize the risk of applying static electricity to the board, and damage it. **DO NOT TOUCH THE ELECTRONICS!**

Gently tweak the board out of its socket.

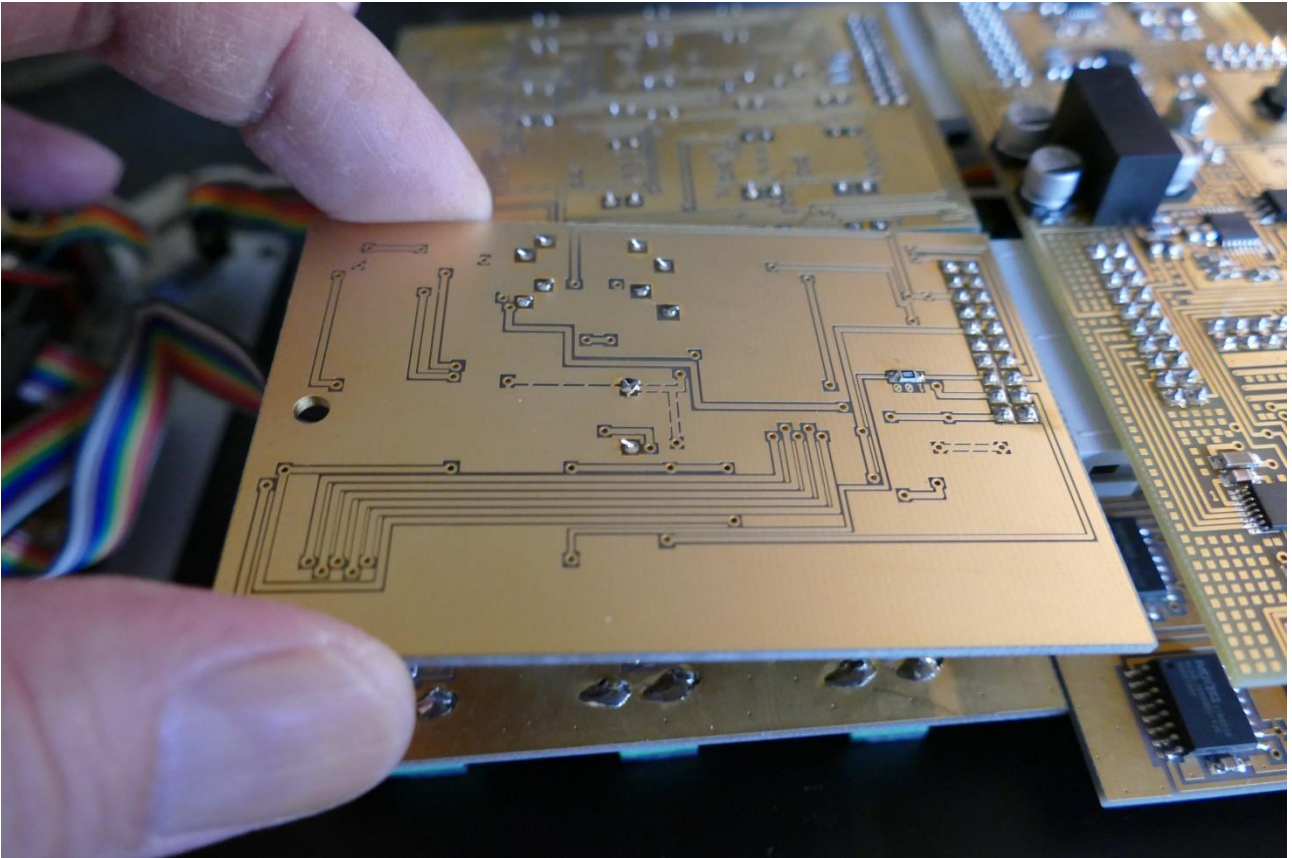

The screw and the washers, that is holding the filterboard in place:

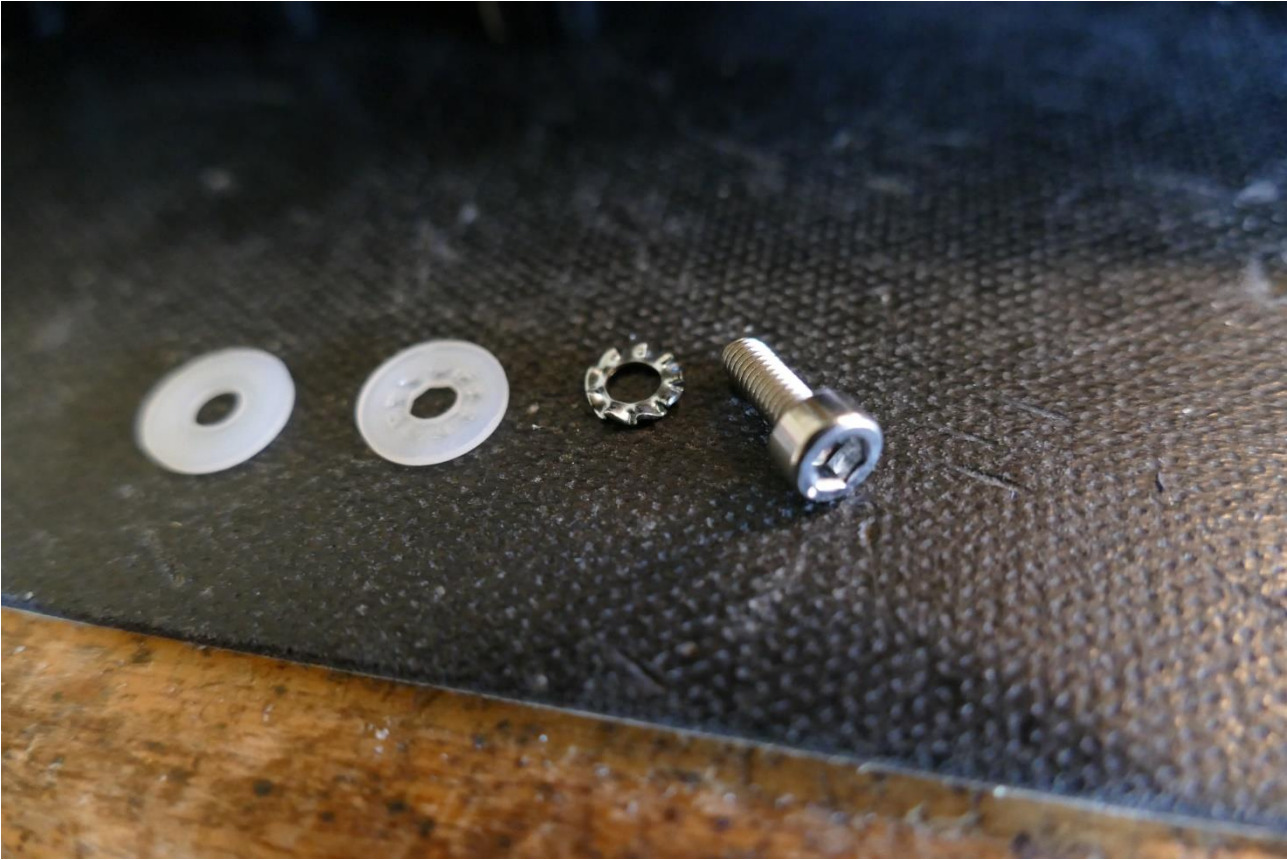

Before you start installing the new filterboard, you should assemble the screw and the washers like this:

- First place the shakeproof washer on the screw.
- The place one of the nylon washers on the screw.
- Leave the other nylon washer for now.

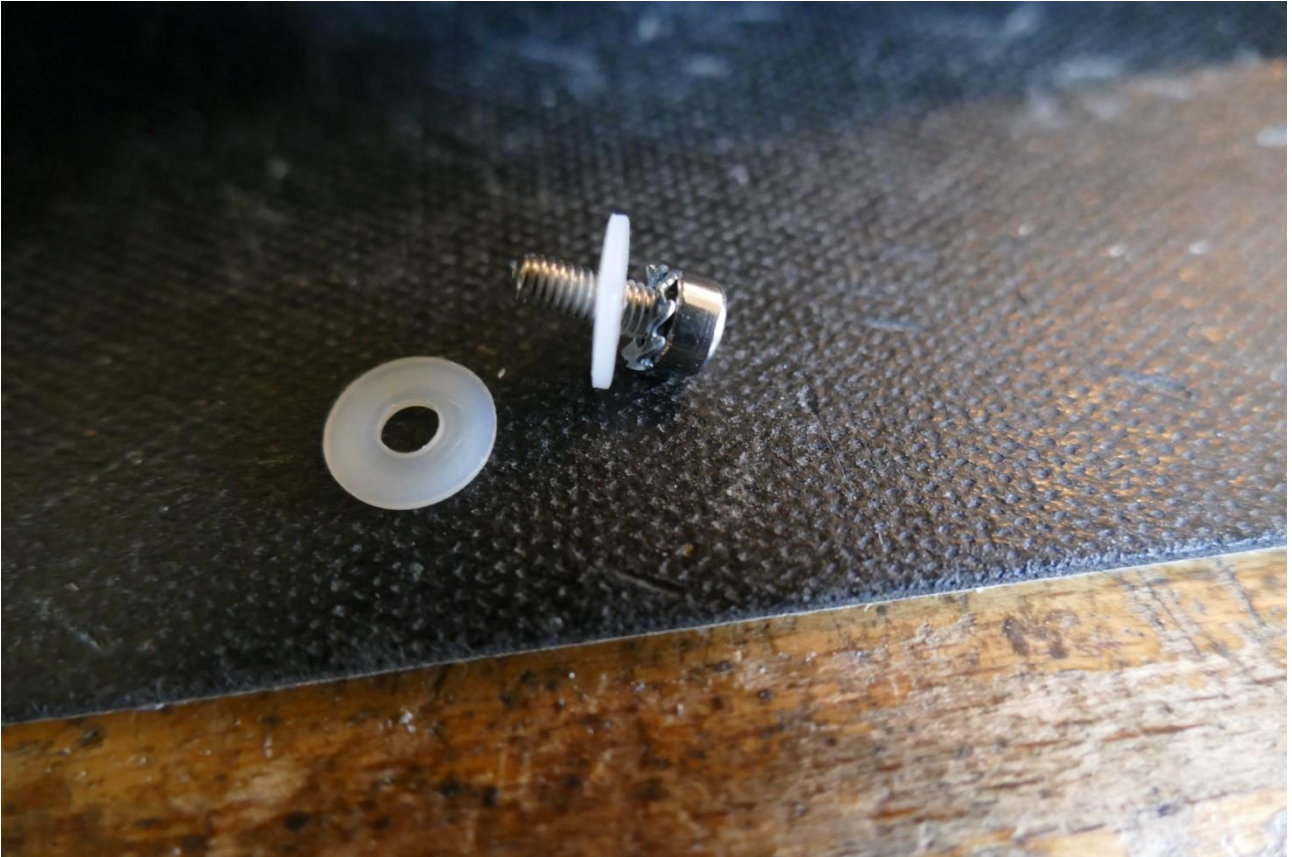

Now, take the new filterboard. Again, touch it only on the sides.

Place it so the connector on the filterboard goes into the middle of the connector on the analog board. Push it all the way in.

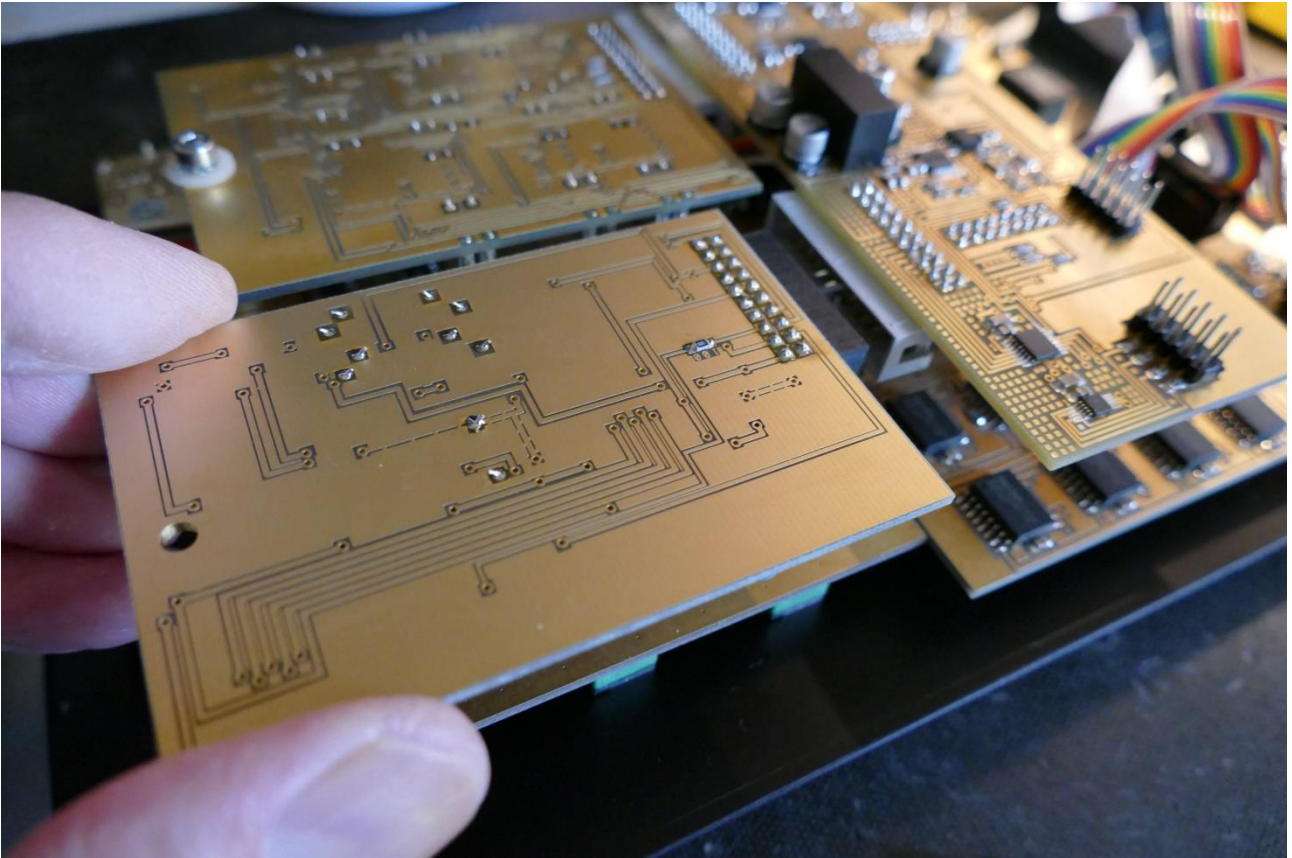

Place a nylon washer between the filterboard and the PCB spacer, that is holding it. Put the screw, with nylon and shakeproof washer mounted, back, and tighten it.

It should now look like this:

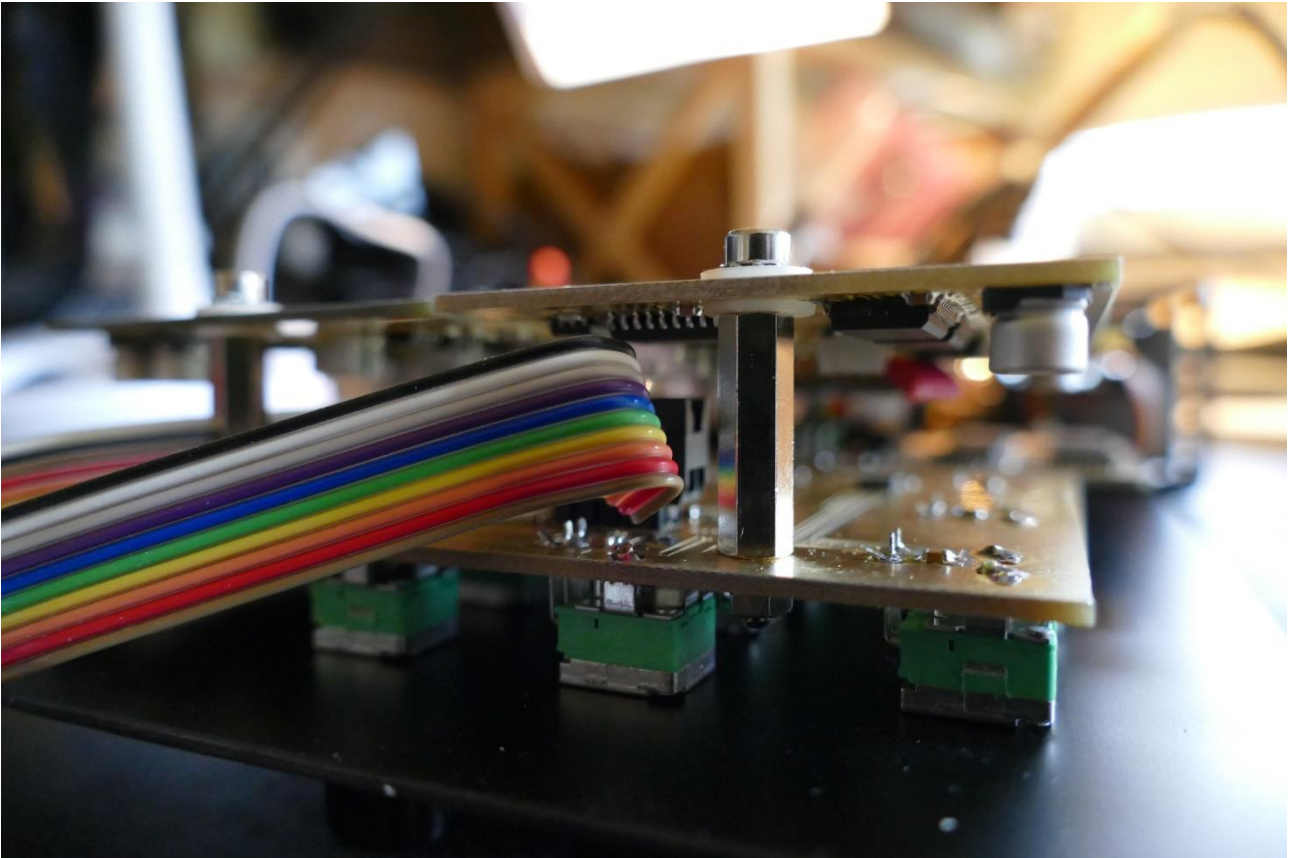

You have now successfully installed a filterboard!
Now it is time to put your LD3 back together again.

Turn it over, so the front panel is facing upwards again.



Slide the front panel into the box, from the right, towards left. Again, hold the left end panel, so that it stays inside the box, to prevent scratching the top of the box.



Put the plastic frame back on the left end panel.

Put the right end panel in place. Take care that none of the cables attached to it, are squeezed between the panel and the box.

Put the 4 screws back, and tighten them.

Put the left end panel in place. . Take care that none of the cables attached to it, are squeezed between the panel and the box, or the panel and the filterboards.

Put the 4 screws back, and tighten them.

Turn your LD3 on and enjoy!

Installing the Analog Board

This chapter will describe how to install the analog board.

You will need the following tools:

- A Phillips screwdriver
- A 2.5mm Allen screwdriver



Before you open your LD3, insert the power supply in a wall socket, and touch the metal on the connector. This will unload you from any static electricity, that might damage the electronics.

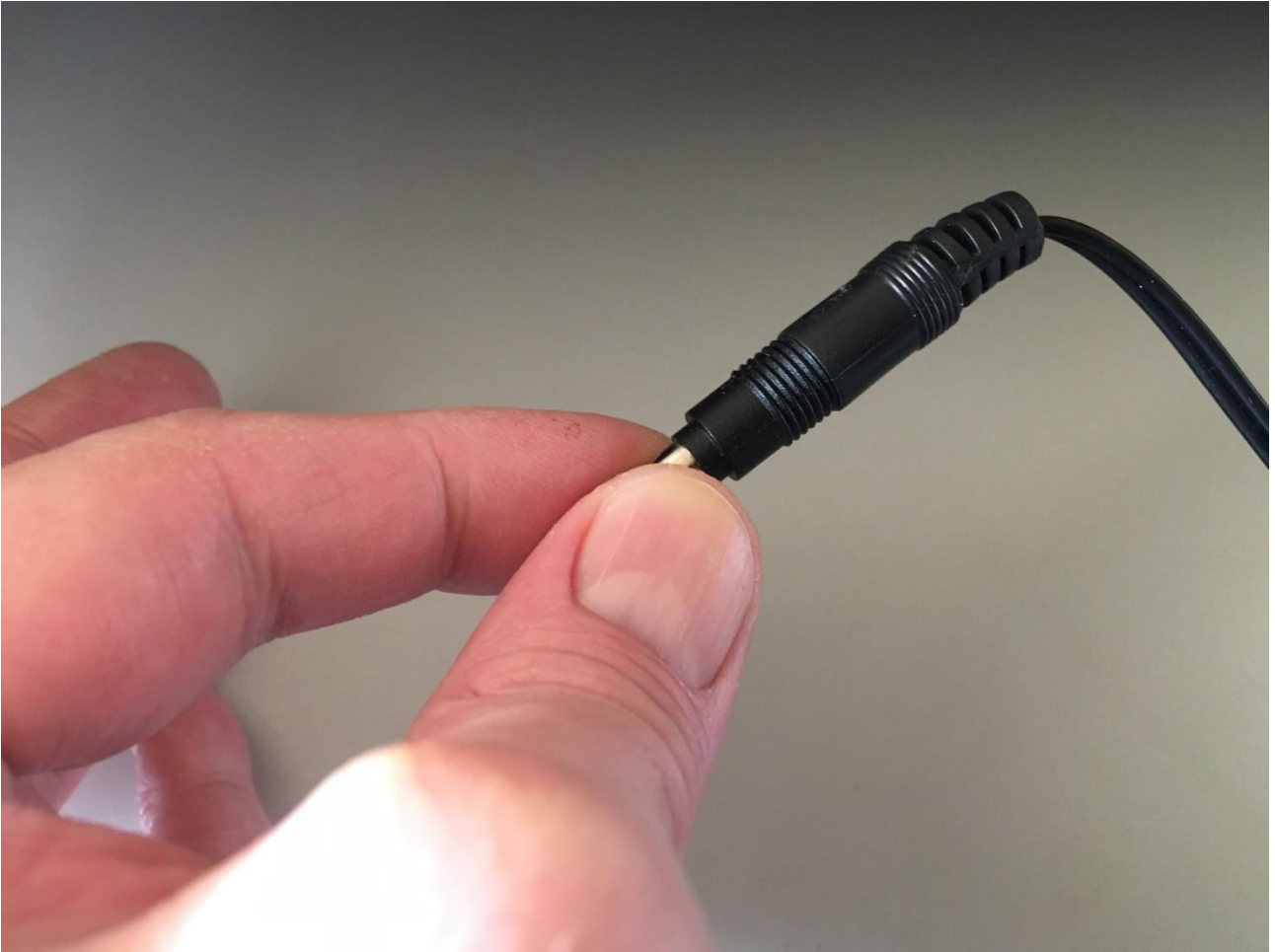

Remove the 4 screws in the corners of the left end panel, using the Phillips screwdriver.



Take the left end panel a bit out.

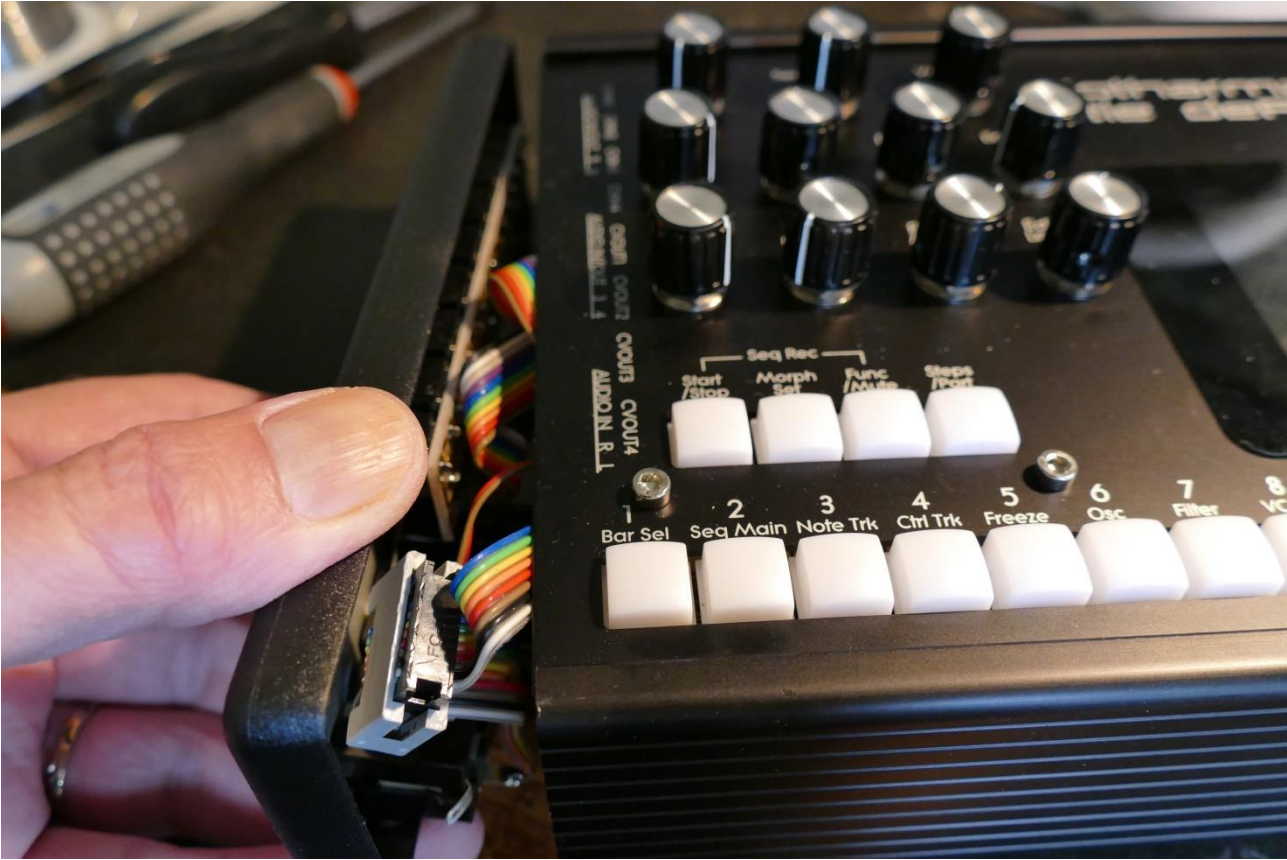

Turn your LD3 around, and remove the 4 screws in the corners of the right end panel, again using the Phillips screwdriver.



Take the right end panel a bit out.



Remove the plastic frame from the left end panel.

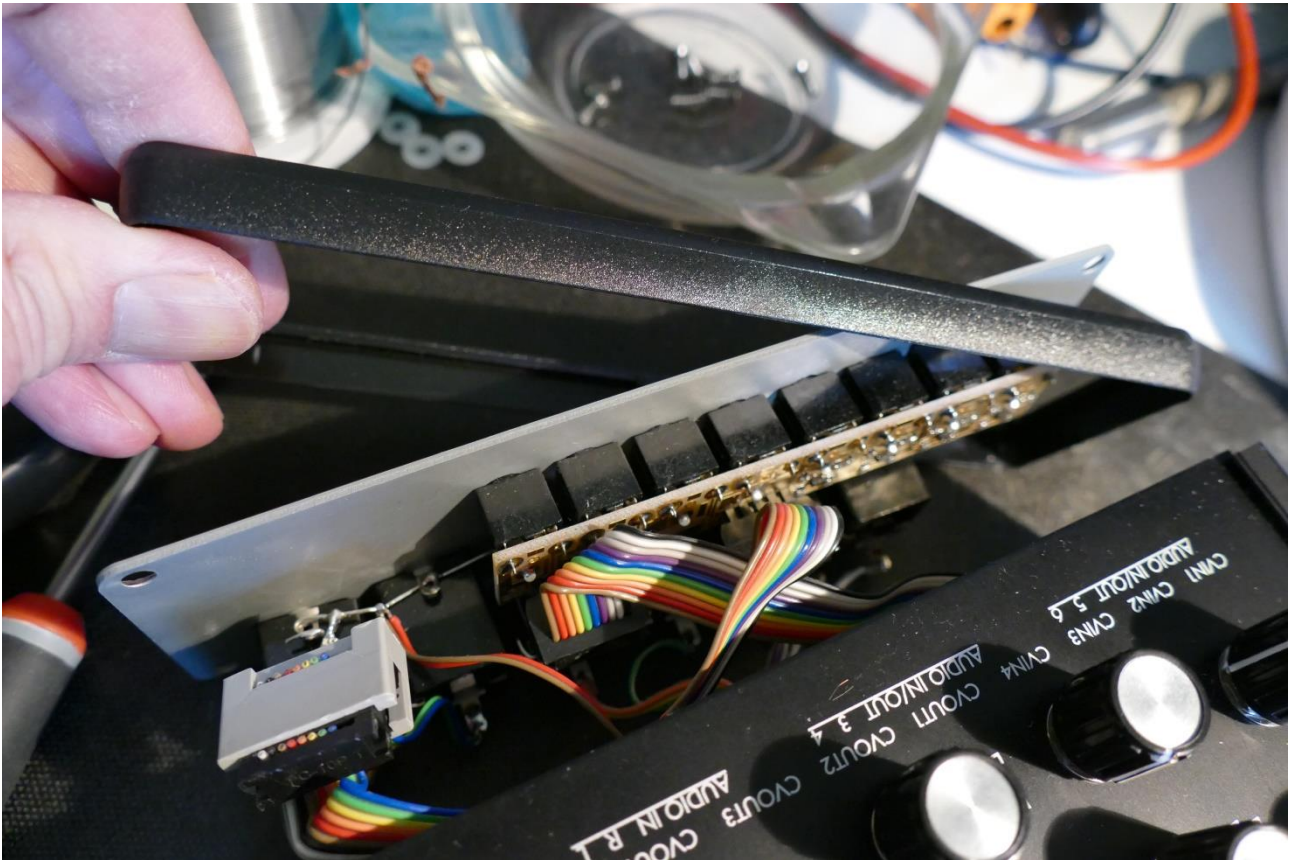

Now carefully slide the front panel towards the right, while navigating the left end panel, to stay inside the box, in order not to scratch the top of the box.



Slide the front panel all the way to the right, so that it is free of the box.

Put the box somewhere else, so you have the front panel and the two end panels for themselves.



Flip LD3 around, so that the front panel is facing downwards.

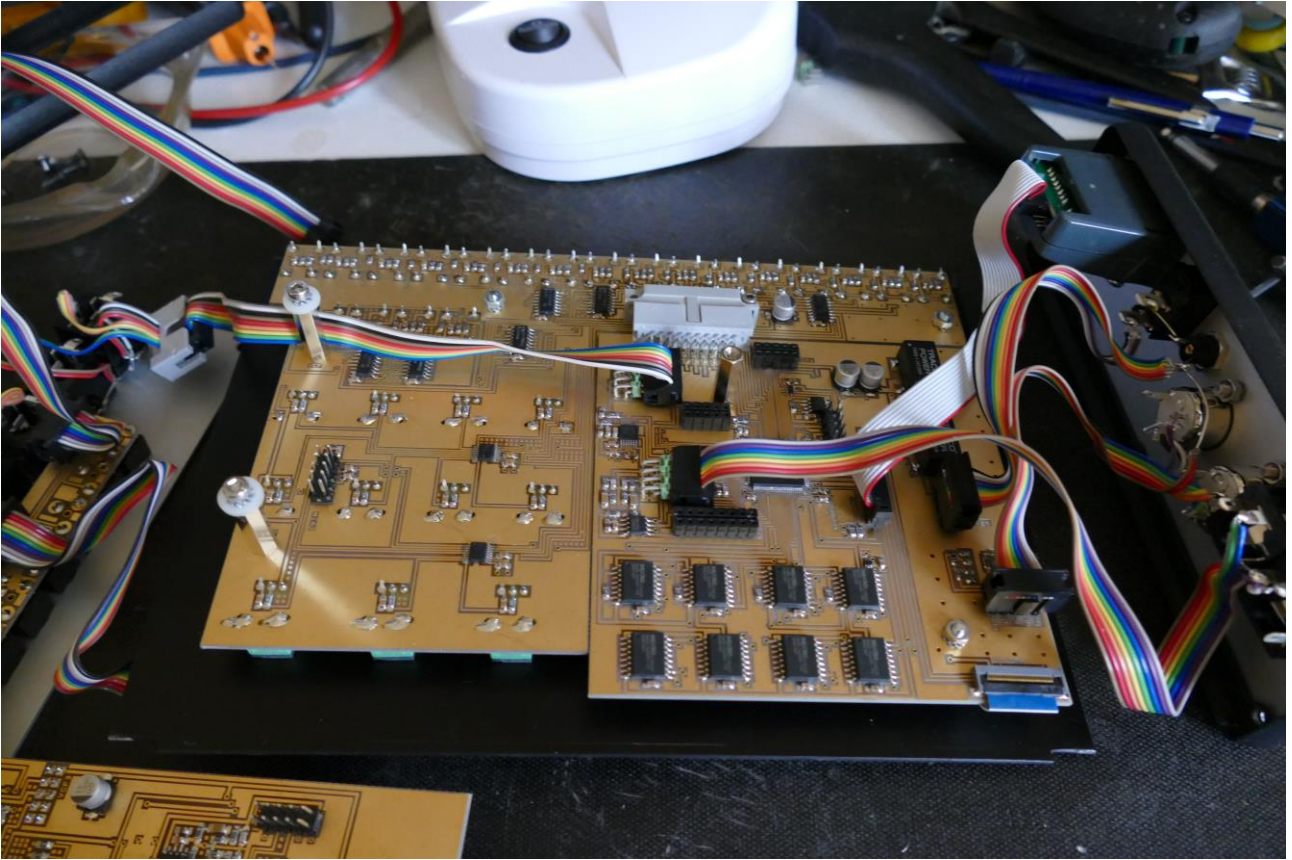

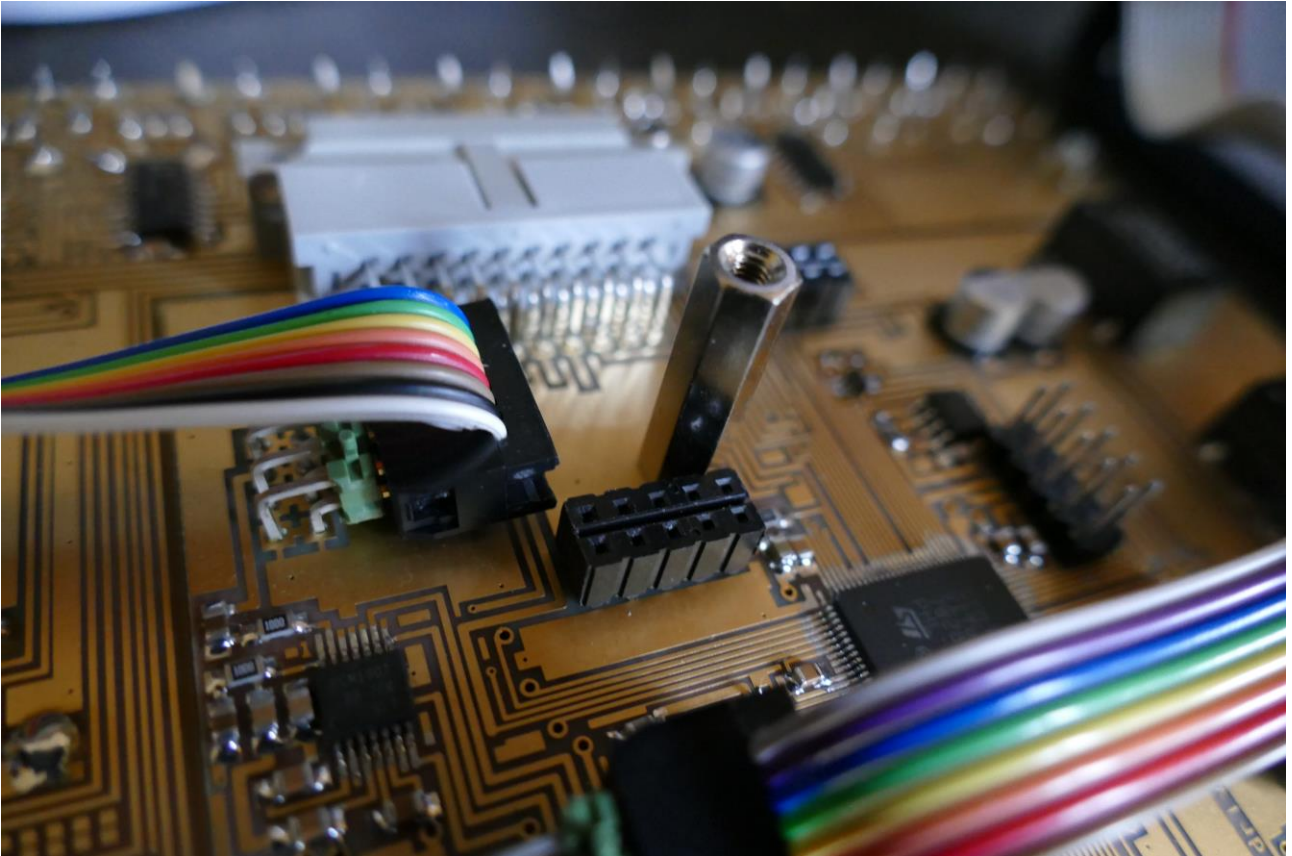

If a screw is located on the spacer on the main board, remove this, so that the spacer looks like on the picture.

Please notice the connector near the spacer. This is one of the connectors, that is needed for the analog board.

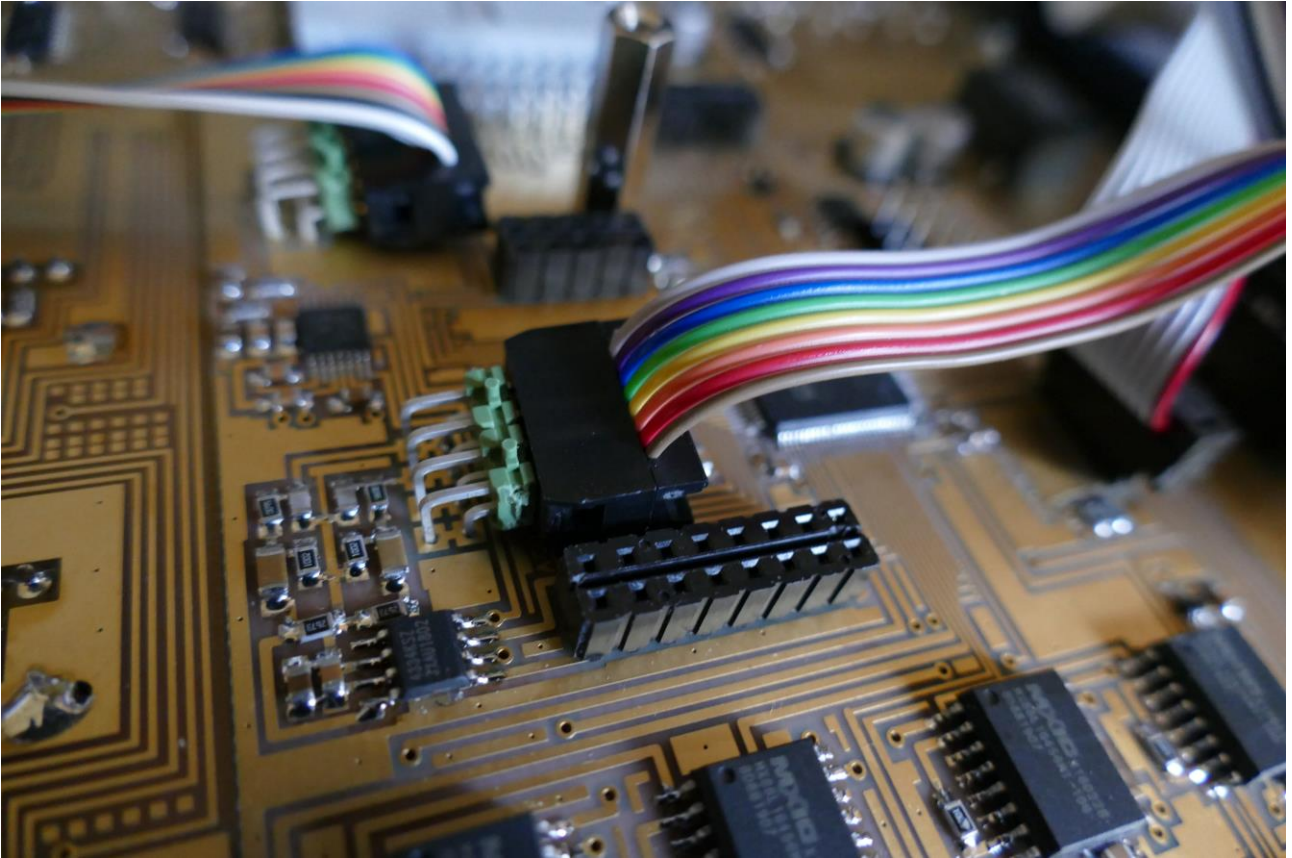

Near the cable, connected to the main audio outputs, are another connector, needed for the analog board.

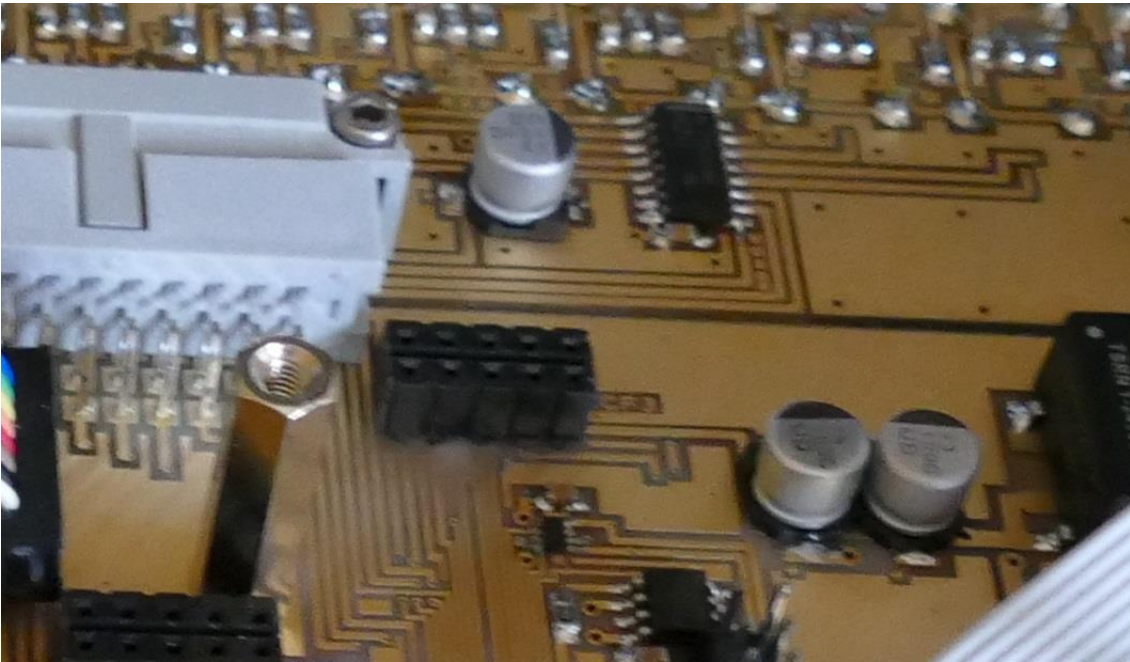

Near the connector to the knob board, are the third connector, needed for the analog board.

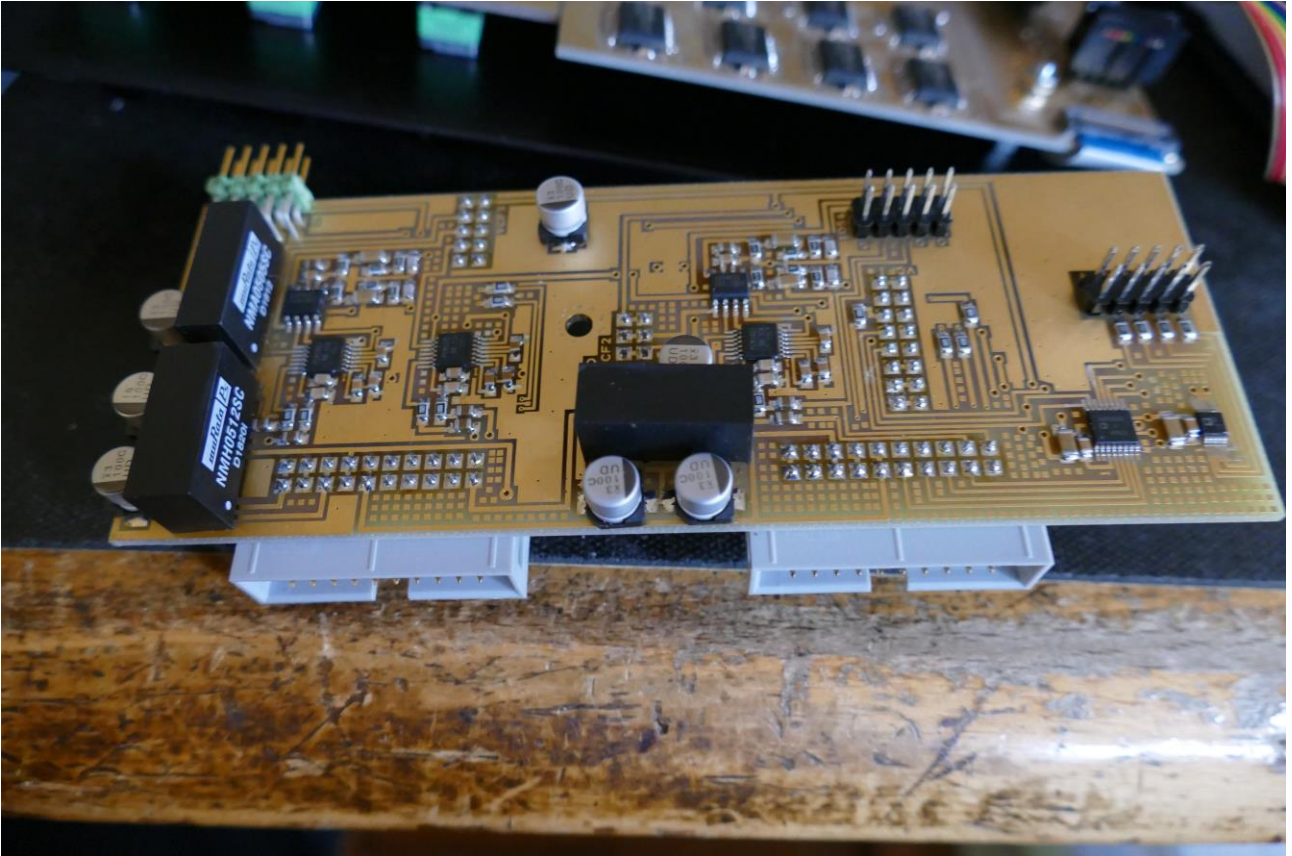

The analog board itself.

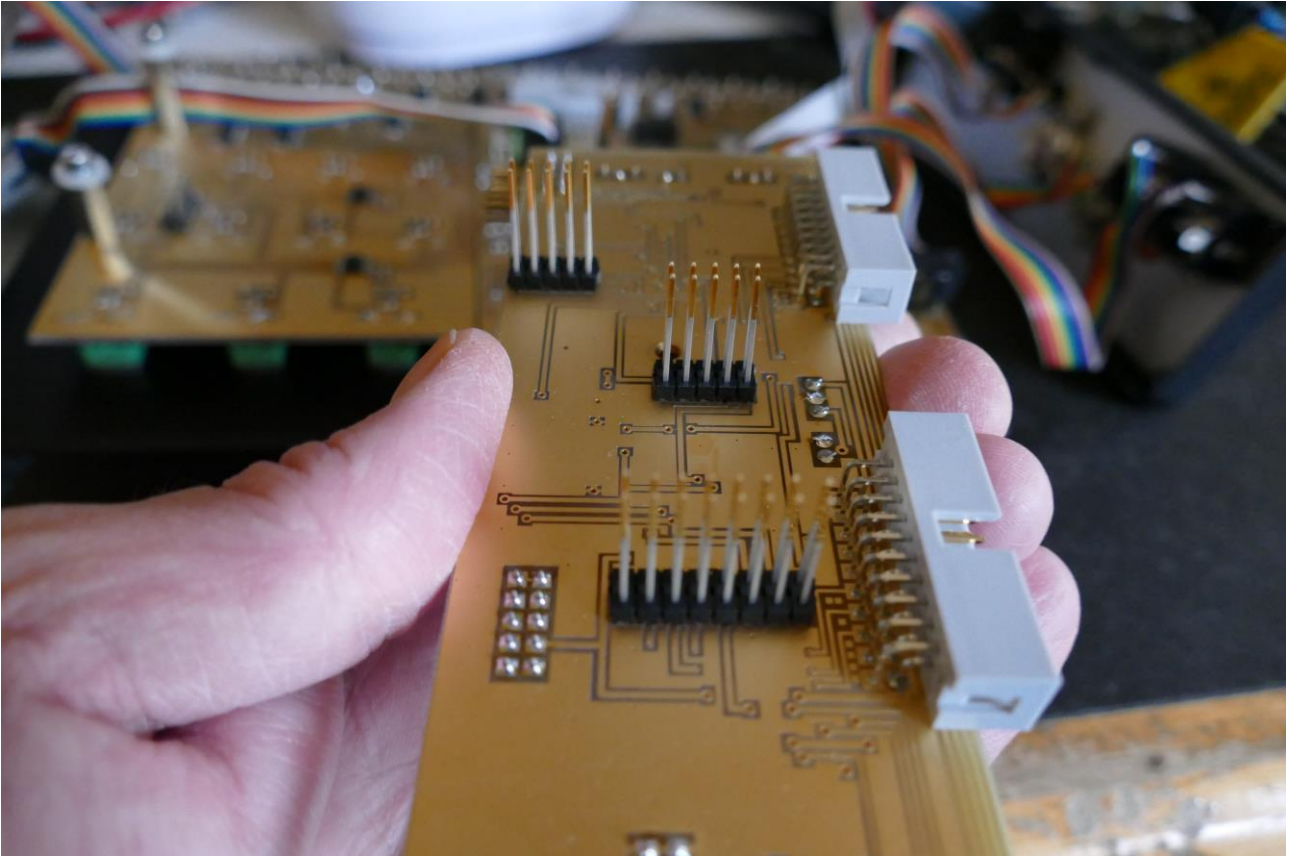

When turned upside down, the 3 connectors, that needs to connect to the LD3 mainboard, shows.

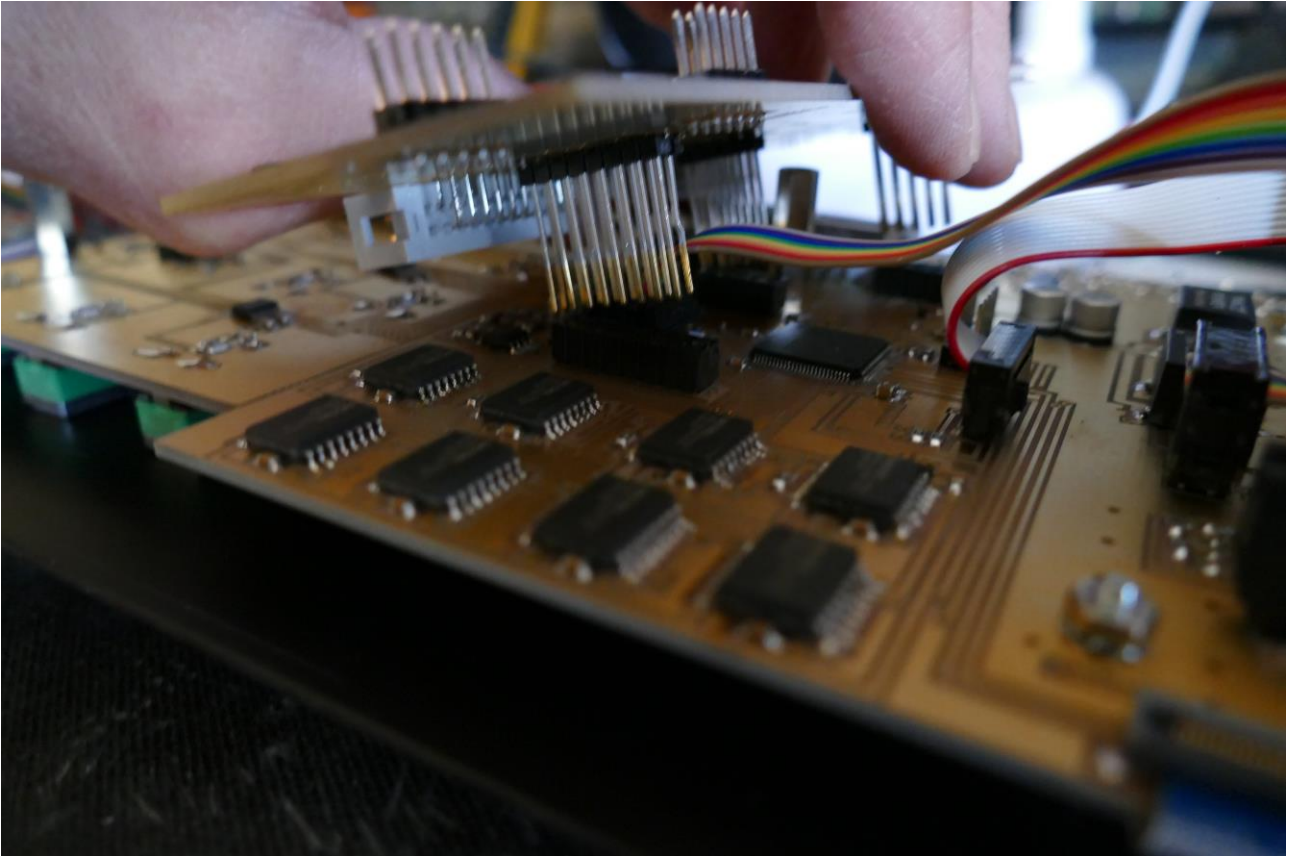

Now carefully attach the analog board to the LD3 main board. Make sure that the connectors on the analog board goes perfectly into the connectors on the main board, and that the filterboard connectors are to the left.

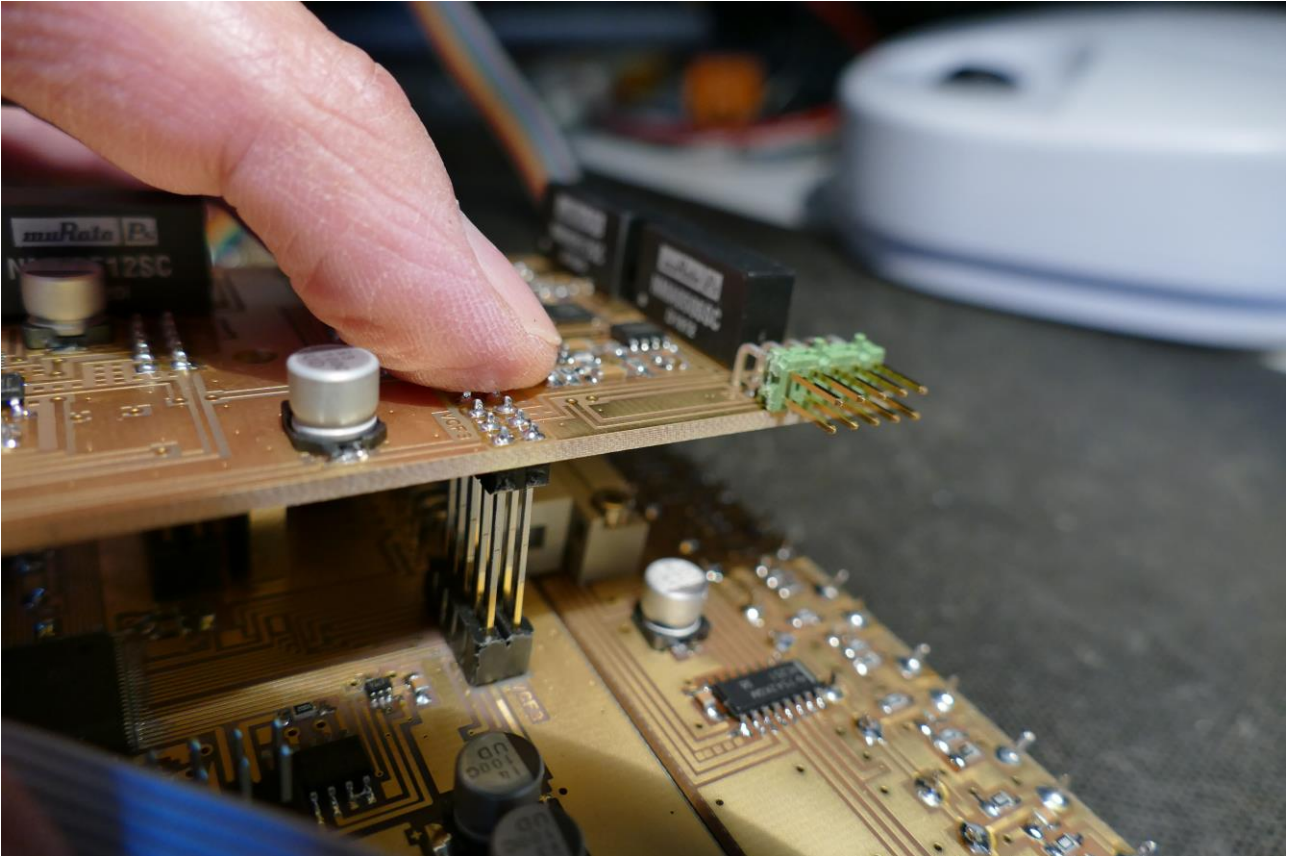

After making sure, that the connectors fits each other perfectly, press the analog board into these.

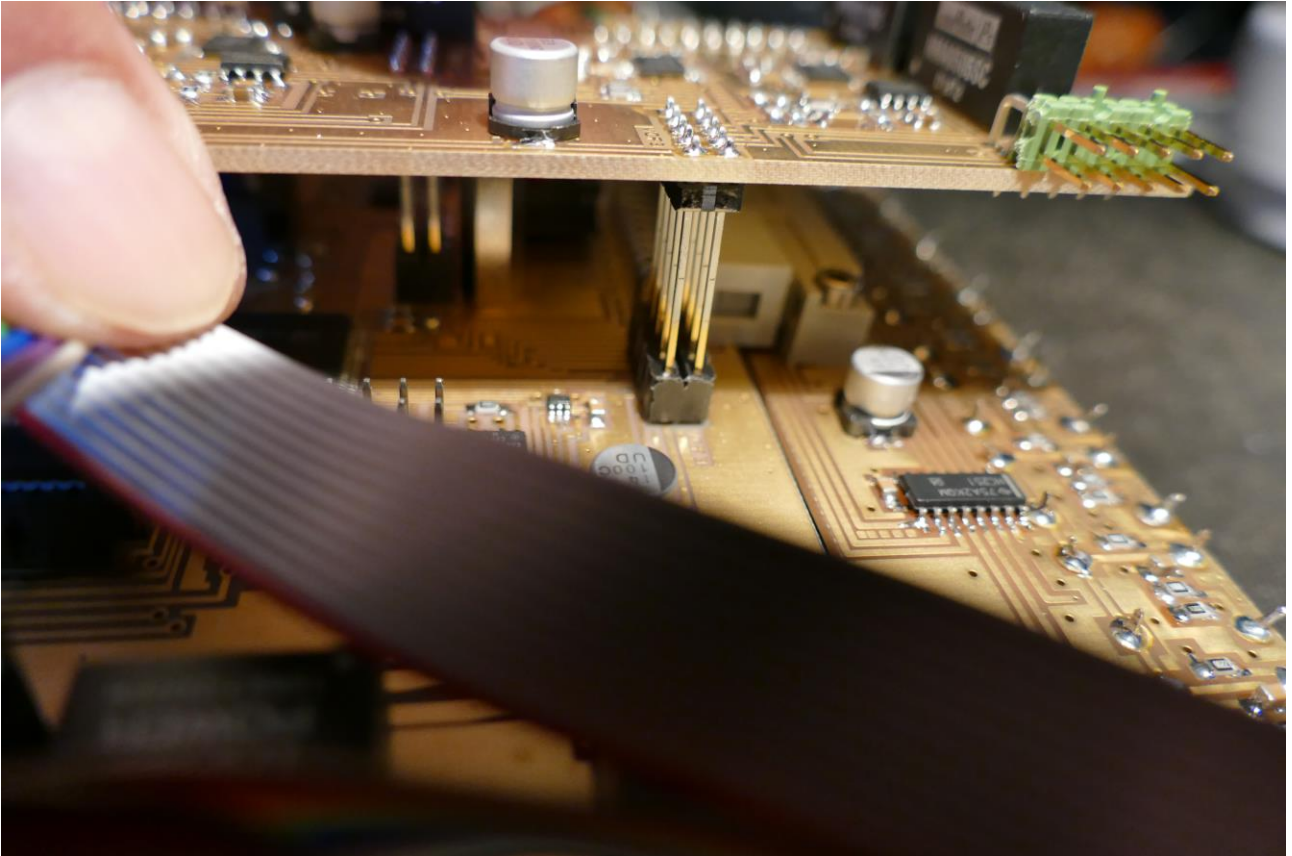

Check an extra time, that the connectors fits. THIS IS VERY IMPORTANT!

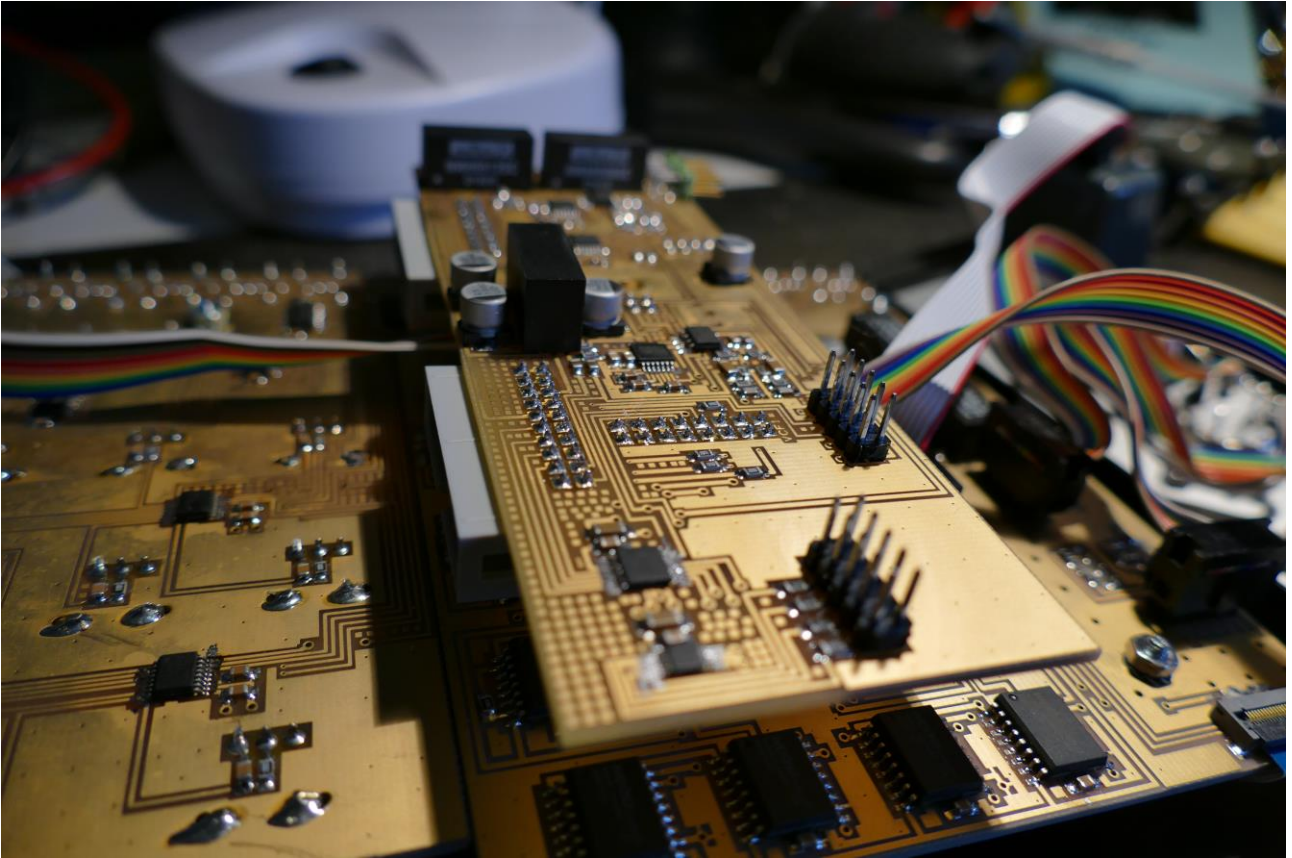

It should now look like this.

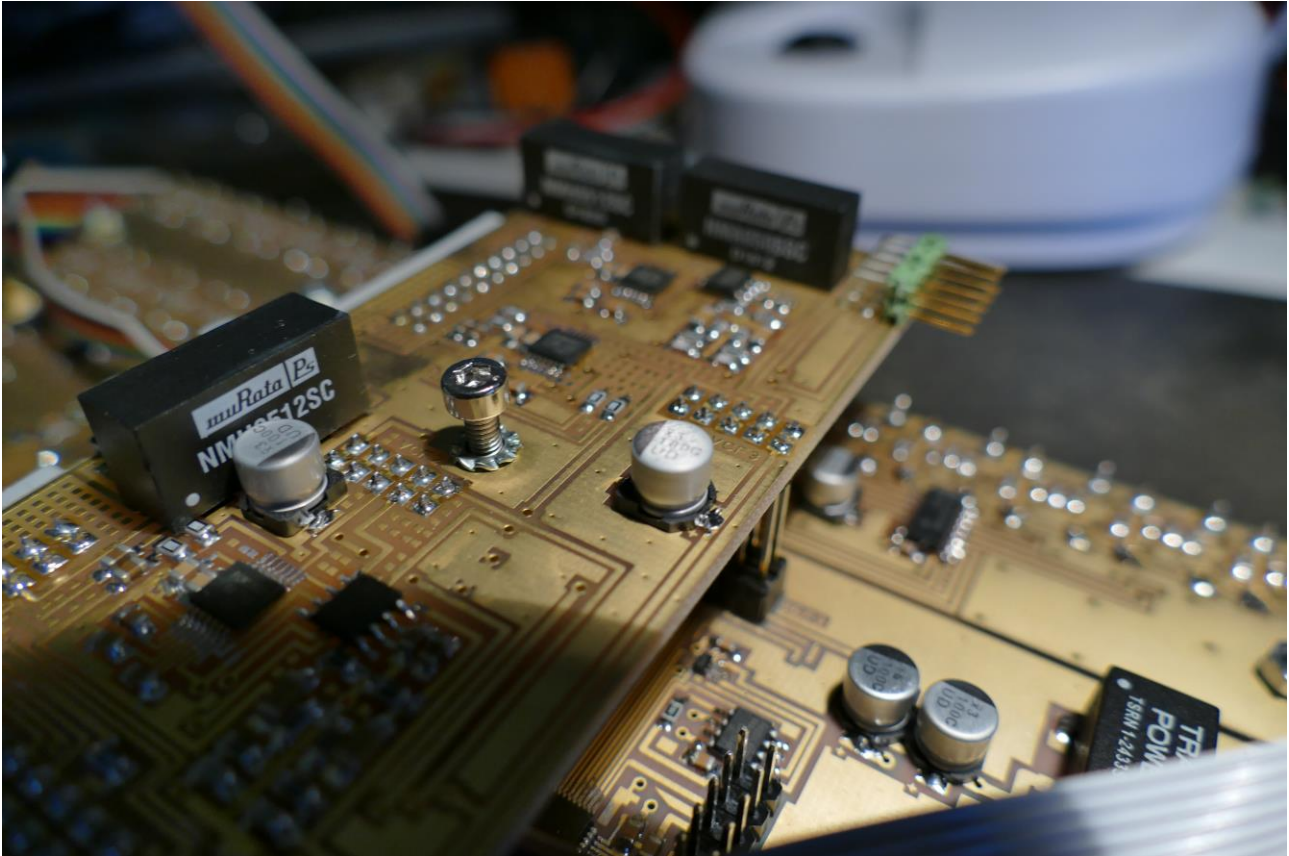

Now mount the screw and the washer, that you removed from the main board spacer, to the spacer again.

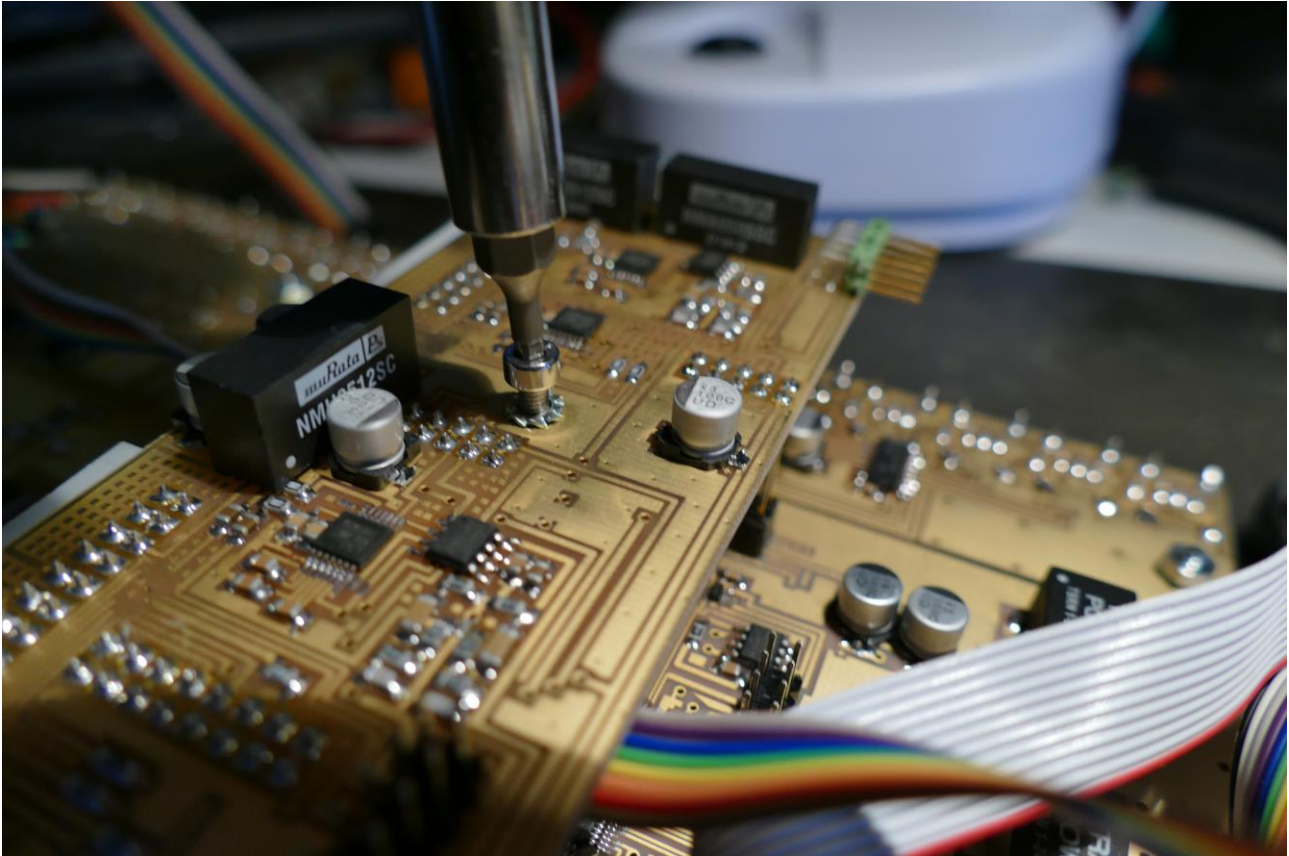

Tighten the screw, using the Allen screwdriver.

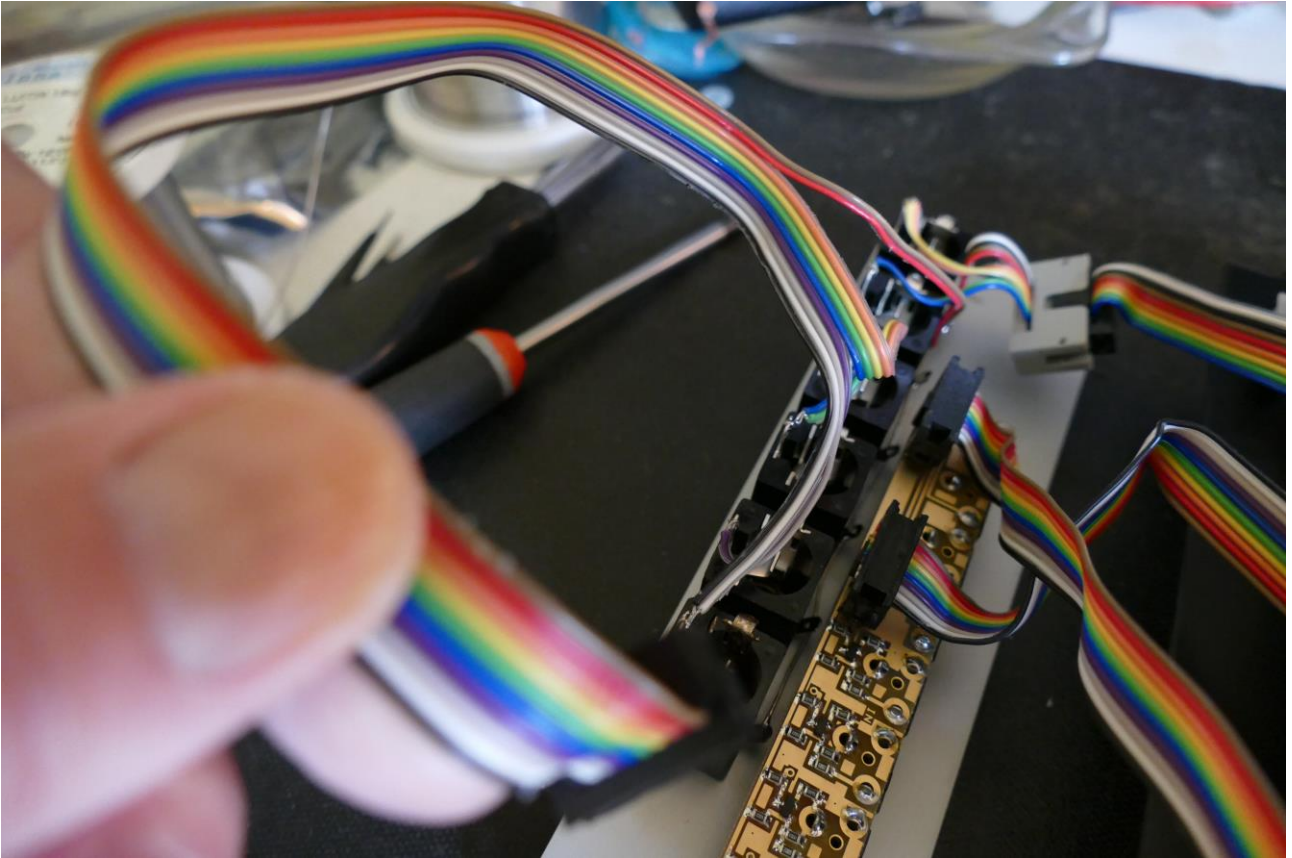

Locate the cable on the left end panel, that is connected to audio in/out 3/4.

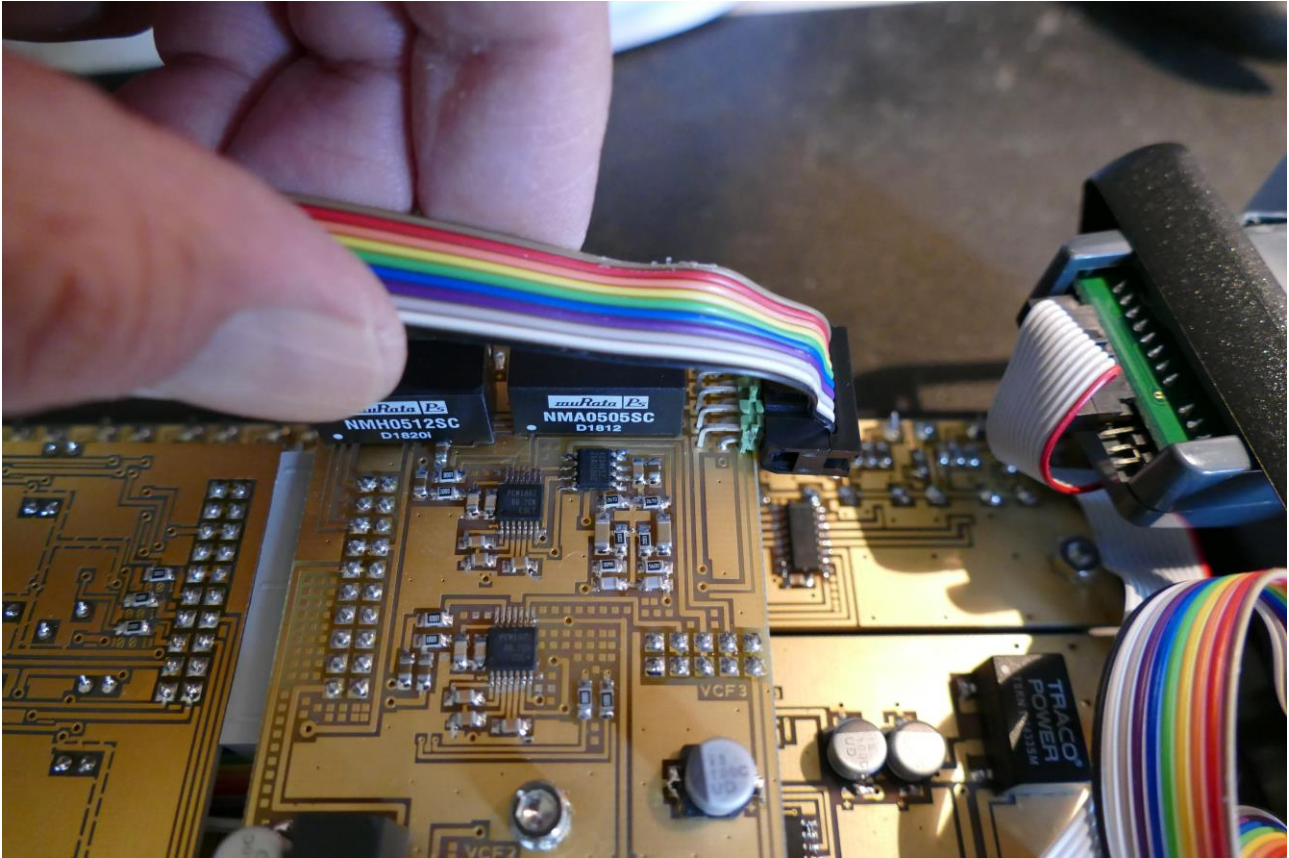

Connect this to the angled connector on the analog board, as shown on the picture.

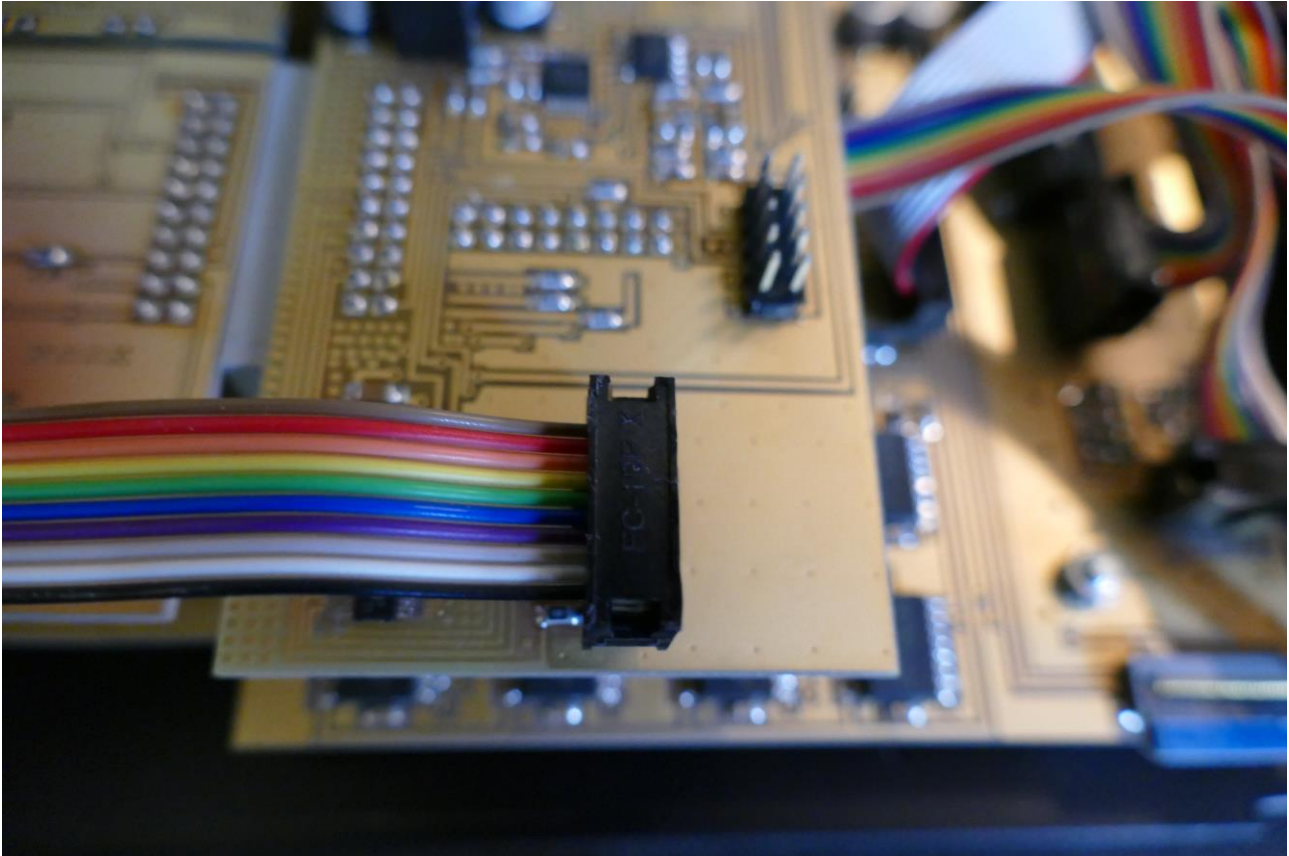

Connect the cable from the CV output minijacks to the straight connector near the edge of the analog board, as shown on the picture.

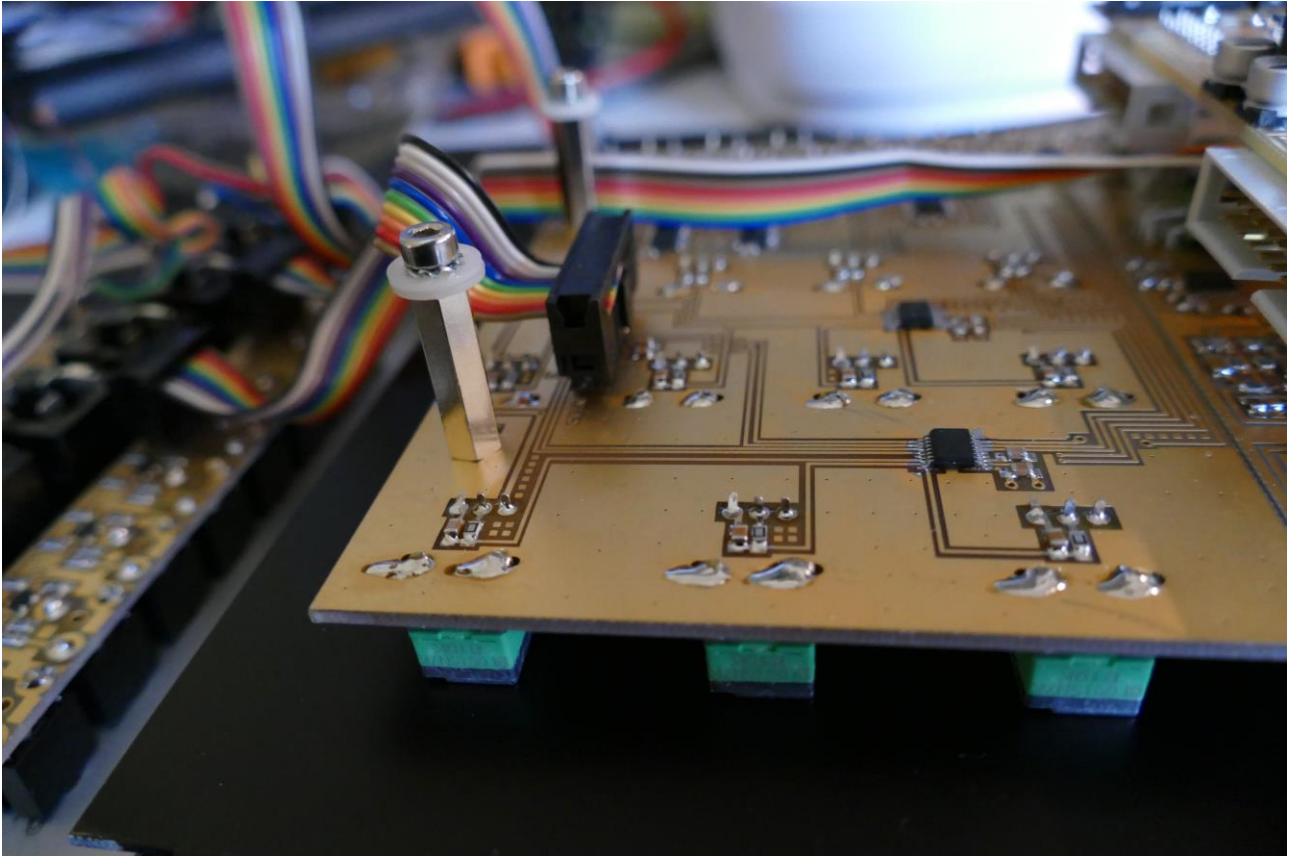

Connect the cable from the CV input minijacks to the connector on the knob board, as shown on the picture.

If you need any filterboards installed, please see the previous chapter regarding installing the filterboards.

Turn LD3 over, so the front panel is facing upwards again.



Slide the front panel into the box, from the right, towards left. Again, hold the left end panel, so that it stays inside the box, to prevent scratching the top of the box.



Put the plastic frame back on the left end panel.

Put the right end panel in place. Take care that none of the cables attached to it, are squeezed between the panel and the box.

Put the 4 screws back, and tighten them.

Put the left end panel in place. . Take care that none of the cables attached to it, are squeezed between the panel and the box, or the panel and the filterboards.

Put the 4 screws back, and tighten them.

Turn your LD3 on and enjoy!

Written by:
Flemming Christensen
Gotharman
2019